

NATIONAL RADIO SYSTEMS COMMITTEE



2500 Wilson Boulevard
Arlington, VA 22201-3834
(703) 907-7500
FAX (703) 907-7501



1771 N Street, NW
Washington, DC 20036-2891
(202) 429-5346
FAX (202) 775-4981

UNITED STATES RBDS STANDARD

April 9, 1998

Specification of the radio broadcast data system (RBDS)

Descriptors: Broadcasting, sound broadcasting, data transmission, frequency modulation, message, specification

FOREWORD

This standard was produced by the Radio Broadcast Data System (RBDS) Subcommittee of the National Radio Systems Committee (NRSC). It reflects input from broadcasters, receiver manufacturers, users and potential users of radio data system services. This standard is compatible with the European Broadcasting Union (EBU)/Cenelec Standard EN50067: 1998, "Specification of the Radio Data System." ¹ It includes all of the specifications in Cenelec EN50067: 1998 plus some additional features for the United States.

The following diagram illustrates the features that have been added to EBU/Cenelec EN50067:1998 to create this standard:

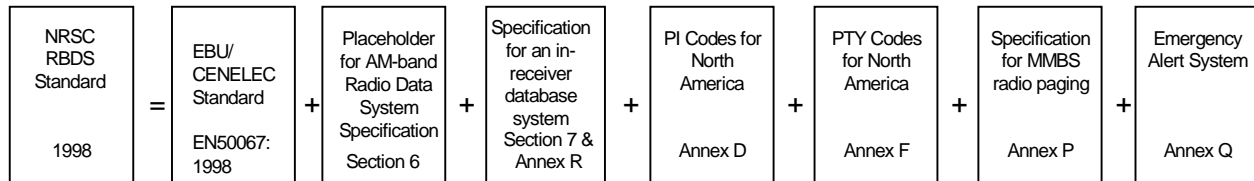

This standard is a voluntary standard. Because its success is largely dependent on the radio listener's ability to use the same radio data system receiver in the same manner in any location, it is hoped that broadcasters and equipment manufacturers will comply with the spirit and the letter of this standard.

This standard contains numerous references to annexes. These annexes form part of the standard.

Special note regarding MMBS: MMBS is a form of MBS radio paging that has been modified for multiplexing with radio data system transmissions. MBS is the Swedish Telecommunications Administration (Televerket) Specification for the Swedish Public Radio Paging System [18]. Radio system designers should note that many broadcasters in the United States are currently transmitting MBS formatted data and paging services. Design criteria to accommodate MMBS radio paging (*i.e.*, MBS radio paging multiplexed with radio data system transmissions) are included in Annex P of this standard and references to MMBS are highlighted within the body of the standard.

Special note regarding in-receiver database system: To incorporate the radio data system features of Program Service name (PS) and Program Type (PTY) it is possible to use an in-receiver database of station information that can be updated and corrected by the radio data system data stream. This makes it possible to immediately implement call letter display and PTY scanning in *both* the FM and AM bands. Information regarding the implementation of an in-receiver database system is included in Section 7 and Annex R.

Recommended Standards and Publications are adopted by the NRSC in accordance with the American National Standards Institute (ANSI) patent policy. By such action, the NRSC does not assume any liability to any patent owner, nor does it assume any obligation whatever to parties adopting the Recommended Standard or Publication. Parties considering adoption of the Recommended Standard or Publication may wish to investigate the existence of relevant patents and patent applications.

The National Radio Systems Committee is jointly sponsored by the Electronic Industries Association (EIA) and the National Association of Broadcasters (NAB). EIA and NAB would like to thank Mr. Almon Clegg, consultant to Denon and past chairman of the NRSC RBDS Subcommittee, and Mr. Scott Wright of Delco Electronics, current chairman of the NRSC RBDS Subcommittee, for all of their hard work in guiding the development of this standard. We would also like to thank Mr. Dietmar Kopitz of the European Broadcasting Union for his guidance. Finally, thanks to all those who have participated at NRSC RBDS Subcommittee meetings over the years.

1

CONTENTS

- 0 Scope 6
- 1 Modulation characteristics of the data channel (physical layer) 6
 - 1.1 Subcarrier frequency 6
 - 1.2 Subcarrier phase 6
 - 1.3 Subcarrier level 8
 - 1.4 Method of modulation 8
 - 1.5 Clock-frequency and data-rate 8
 - 1.6 Differential coding 8
 - 1.7 Data-channel spectrum shaping 9
- 2 Baseband coding (data-link layer) 12
 - 2.1 Baseband coding structure 12
 - 2.2 Order of bit transmission 12
 - 2.3 Error protection 13
 - 2.4 Synchronization of blocks and groups 14
- 3 Message format (session and presentation layers) 15
 - 3.1 Addressing 15
 - 3.1.1 Design principles 15
 - 3.1.2 Principal features 15
 - 3.1.3 Group types 17
 - 3.1.4 Open data channel / Applications Identification 19
 - 3.1.4.1 Use of Open data applications 19
 - 3.1.4.2 Open data applications - Group structure 20
 - 3.1.5 Coding of the Group types 21
 - 3.1.5.1 Type 0 groups: Basic tuning and switching information 21
 - 3.1.5.2 Type 1 groups: Program-item number and slow labeling codes 23
 - 3.1.5.3 Type 2 groups: Radiotext 25
 - 3.1.5.4 Type 3A groups: Applications Identification for Open Data 27
 - 3.1.5.5 Type 3B groups: Open data application 28
 - 3.1.5.6 Type 4A groups: Clock-time and date 28
 - 3.1.5.7 Type 4B groups: Open data application 29
 - 3.1.5.8 Type 5 groups : Transparent data channels or ODA 29
 - 3.1.5.9 Type 6 groups : In house applications or ODA 30
 - 3.1.5.10 Type 7A groups: Radio paging or ODA 31
 - 3.1.5.11 Type 7B groups : Open data application 31
 - 3.1.5.12 Type 8 groups: Traffic Message Channel or ODA 32
 - 3.1.5.13 Type 9 groups: Emergency warning systems or ODA 33
 - 3.1.5.14 Type 10 groups: Program Type Name (Group type 10A) and Open data (Group type 10B) 34
 - 3.1.5.15 Type 11 groups: Open data application 35
 - 3.1.5.16 Type 12 groups: Open data application 36
 - 3.1.5.17 Type 13A groups: Enhanced Radio paging or ODA 36
 - 3.1.5.18 Type 13B groups : Open data application 37
 - 3.1.5.19 Type 14 groups: Enhanced Other Networks information 38
 - 3.1.5.20 Type 15A groups 39
 - 3.1.5.21 Type 15B groups: Fast tuning and switching information 40

3.2 Coding of information	41
3.2.1 Coding of information for control	41
3.2.1.1 Program-identification (PI) codes and Extended Country codes (ECC)	41
3.2.1.2 Program-type (PTY) codes	41
3.2.1.3 Traffic-program (TP) and traffic-announcement (TA) codes	41
3.2.1.4 Music/speech (M/S) switch code	41
3.2.1.5 Decoder-identification (DI) codes	42
3.2.1.6 Coding of Alternative frequencies (AFs) in type 0A groups	42
3.2.1.7 Program-item number (PIN) codes	47
3.2.1.8 Coding of Enhanced Other Networks information (EON)	47
3.2.2 Coding and use of information for display	51
3.2.3 Coding of clock-time and date	51
3.2.4 Coding of information for Transparent data channels	51
3.2.5 Coding of information for In-house applications	52
3.2.6 Coding of Radio paging (RP)	52
3.2.6.1 Introduction	52
3.2.6.2 Identification of paging networks	53
3.2.7 Coding of Emergency warning systems (EWS)	54
4 Description of features	55
5 Marking	59
6 AM RDS	60
7 In-Receiver Database System (I-RDS)	61

ANNEXES

A - Offset words to be used for group and block synchronization (normative) 70

B - Theory and implementation of the modified shortened cyclic code (informative) 71

C - Implementation of group and block synchronization using the modified shortened
cyclic code (informative) 77

D - Program identification codes and Extended country codes (normative) 80

E - Character definition for Program Service name, Program Type Name, Radiotext and
alphanumeric Radio paging (normative) 91

F - Program Type codes (normative) 95

G - Conversion between time and date conventions (informative) 103

H - Specification of the ARI system (informative) 105

J - Language identification (normative) 106

K - RDS logo (informative) 108

L - Open data registration (informative) 109

M - Coding of Radio Paging (normative) 116

N - Country codes and Extended country codes for countries outside the
European Broadcasting Area (normative) 152

P - Coding of MMBS Radio Paging, Data and In-House Application (normative) 157

Q - Emergency Alert System Open Data Application (normative) 178

R - In-Receiver Database System (I-RDS) File Structure (normative) 184

S - List of Abbreviations (normative) 203

T - Bibliography (informative) 204

0 Scope

The Radio Data System, RDS, is intended for application to VHF/FM sound broadcasts in the range 87.5 MHz to 108.0 MHz which may carry either stereophonic (pilot-tone system) or monophonic programs. The main objectives of RDS are to enable improved functionality for FM receivers and to make them more user-friendly by using features such as Program Identification, Program Service name display and where applicable, automatic tuning for portable and car radios, in particular. The relevant basic tuning and switching information shall therefore be implemented by the type 0 group (see 3.1.5.1), and it is not optional unlike many of the other possible features in RDS.

1 Modulation characteristics of the data channel (physical layer)

The Radio Data System is intended for application to VHF/FM sound broadcasting transmitters in the range 87.5 to 108.0 MHz, which carry stereophonic (pilot-tone system) or monophonic sound broadcasts (see ITU-R Recommendation 450-2).

It is important that radio-data receivers are not affected by signals in the multiplex spectrum outside the data channel.

The system can be used simultaneously with the ARI system (see annex H), even when both systems are broadcast from the same transmitter. However, certain constraints on the phase and injection levels of the radio-data and ARI signals must be observed in this case (see 1.2 and 1.3).

The data signals are carried on a subcarrier which is added to the stereo multiplex signal (or monophonic signal as appropriate) at the input to the VHF/FM transmitter. Block diagrams of the data source equipment at the transmitter and a typical receiver arrangement are shown in figures 1 and 2, respectively.

1.1 Subcarrier frequency

During stereo broadcasts the subcarrier frequency will be locked to the third harmonic of the 19-kHz pilot-tone. Since the tolerance on the frequency of the 19-kHz pilot-tone is ± 2 Hz (see ITU-R Recommendation 450-2), the tolerance on the frequency of the subcarrier during stereo broadcasts is ± 6 Hz.

During monophonic broadcasts the frequency of the subcarrier will be $57 \text{ kHz} \pm 6 \text{ Hz}$.

1.2 Subcarrier phase

During stereo broadcasts the subcarrier will be locked either in phase or in quadrature to the third harmonic of the 19 kHz pilot-tone. The tolerance on this phase angle is $\pm 10^\circ$, measured at the modulation input to the FM transmitter.

In the case when ARI and radio-data signals are transmitted simultaneously, the phase angle between the two subcarriers shall be $90^\circ \pm 10^\circ$.

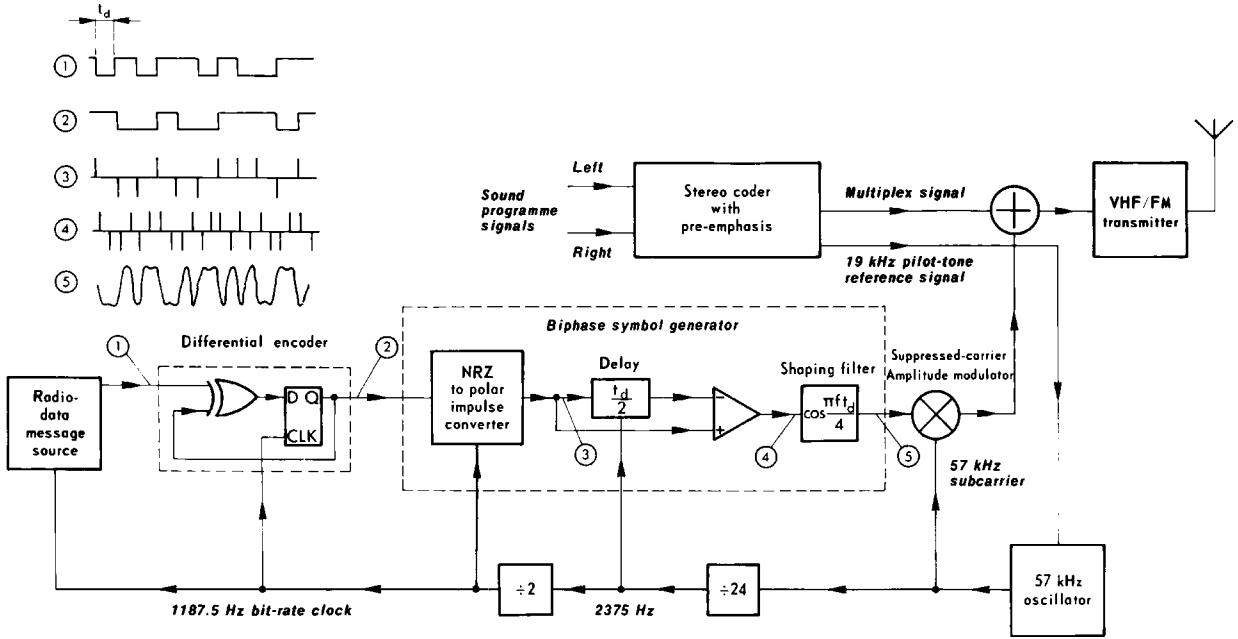

Figure 1: Block diagram of radio-data equipment at the transmitter

* The overall data-shaping in this decoder comprises the filter F_1 and the data-shaping inherent in the biphase symbol decoder. The amplitude/frequency characteristic of filter F_1 is, therefore, not the same as that given in figure 3.

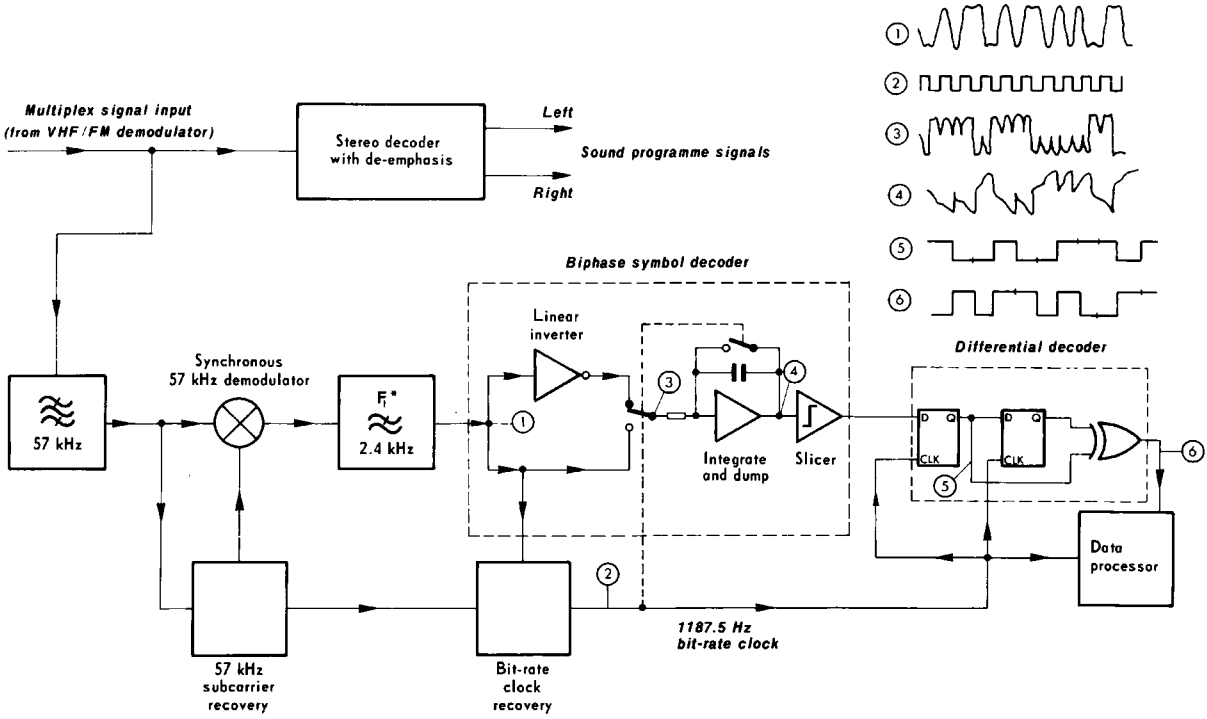

Figure 2: Block diagram of a typical radio-data receiver/decoder

1.3 Subcarrier level

The deviation range of the FM carrier due to the unmodulated subcarrier is from ± 1.0 kHz to ± 7.5 kHz. The recommended best compromise is ± 2.0 kHz². The decoder/demodulator should also operate properly when the deviation of the subcarrier is varied within these limits during periods not less than 10 ms.

In the case when ARI (see annex H) and radio-data signals are transmitted simultaneously, the recommended maximum deviation due to the radio-data subcarrier is ± 1.2 kHz and that due to the unmodulated ARI subcarrier should be reduced to ± 3.5 kHz.

The maximum permitted deviation due to the composite multiplex signal is ± 75 kHz.

1.4 Method of modulation

The subcarrier is amplitude-modulated by the shaped and biphase coded data signal (see 1.7). The subcarrier is suppressed. This method of modulation may alternatively be thought of as a form of two-phase phase-shift-keying (psk) with a phase deviation of $\pm 90^\circ$.

1.5 Clock-frequency and data-rate

The basic clock frequency is obtained by dividing the transmitted subcarrier frequency by 48. Consequently, the basic data-rate of the system (see figure 1) is 1187.5 bit/s \pm 0.125 bit/s.

1.6 Differential coding

The source data at the transmitter are differentially encoded according to the following rules:

Table 1: Encoding rules

Previous output (at time t_{i-1})	New input (at time t_i)	New output (at time t_i)
0	0	0
0	1	1
1	0	1
1	1	0

where t_i is some arbitrary time and t_{i-1} is the time one message-data clock-period earlier, and where the message-data clock-rate is equal to 1187.5 Hz.

² With this level of subcarrier, the level of each sideband of the subcarrier corresponds to half the nominal peak deviation level of ± 2.0 kHz for an "all-zeroes" message data stream (i.e. a continuous bit-rate sine-wave after biphase encoding).

Thus, when the input-data level is 0, the output remains unchanged from the previous output bit and when an input 1 occurs, the new output bit is the complement of the previous output bit.

In the receiver, the data may be decoded by the inverse process:

Table 2: Decoding rules

Previous input (at time t_{i-1})	New input (at time t_i)	New output (at time t_i)
0	0	0
0	1	1
1	0	1
1	1	0

The data is thus correctly decoded whether or not the demodulated data signal is inverted.

1.7 Data-channel spectrum shaping

The power of the data signal at and close to the 57 kHz subcarrier is minimized by coding each source data bit as a biphasic symbol.

This is done to avoid data-modulated cross-talk in phase-locked-loop stereo decoders, and to achieve compatibility with the ARI system. The principle of the process of generation of the shaped biphasic symbols is shown schematically in figure 1. In concept each source bit gives rise to an odd impulse-pair, $e(t)$, such that a logic 1 at source gives:

$$e(t) = \delta(t) - \delta(t - t_d / 2) \tag{1}$$

and a logic 0 at source gives:

$$e(t) = -\delta(t) + \delta(t - t_d / 2) \tag{2}$$

These impulse-pairs are then shaped by a filter $H_T(f)$, to give the required band-limited spectrum where:

$$H_T(f) = \begin{cases} \cos \frac{\pi f t_d}{4} & \text{if } 0 \leq f \leq 2/t_d \\ 0 & \text{if } f > 2/t_d \end{cases} \tag{3}$$

and here

$$t_d = \frac{1}{1187.5} \text{ s}$$

The data-spectrum shaping filtering has been split equally between the transmitter and receiver (to give optimum performance in the presence of random noise) so that, ideally, the data filtering at the receiver should be identical to that of the transmitter, i.e. as given above in equation (3). The overall data-channel spectrum shaping $H_o(f)$ would then be 100% cosine roll-off.

The specified transmitter and receiver low-pass filter responses, as defined in equation (3) are illustrated in figure 3, and the overall data-channel spectrum shaping is shown in figure 4.

The spectrum of the transmitted biphas-coded radio-data signal is shown in figure 5 and the time-function of a single biphas symbol (as transmitted) in figure 6.

The 57 kHz radio-data signal waveform at the output of the radio-data source equipment may be seen in the photograph of figure 7.

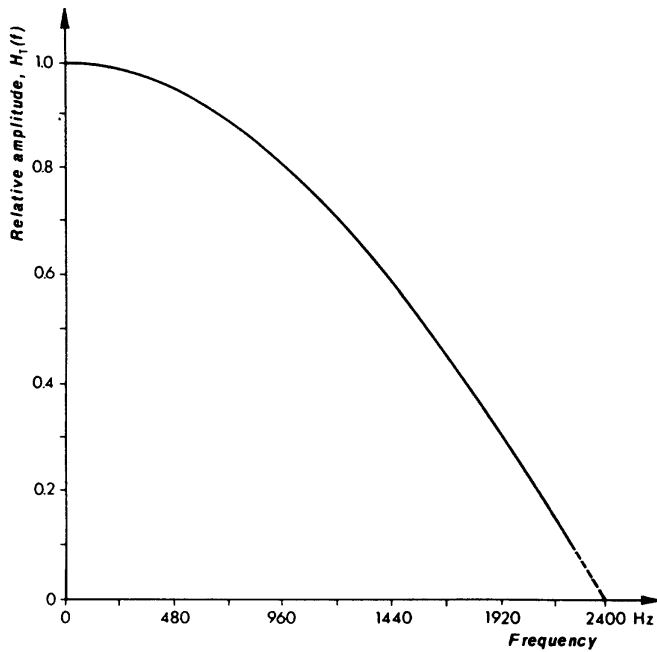

Figure 3: Amplitude response of the specified transmitter or receiver data-shaping filter

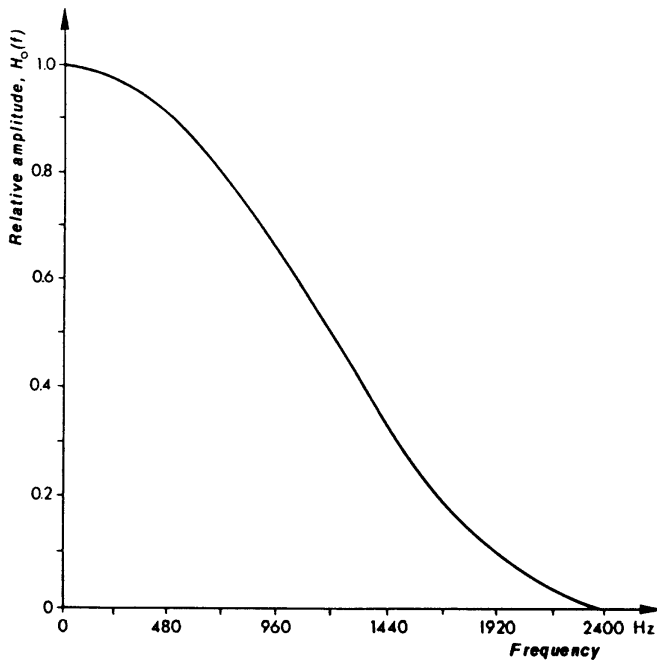

Figure 4: Amplitude response of the combined transmitter and receiver data-shaping filters

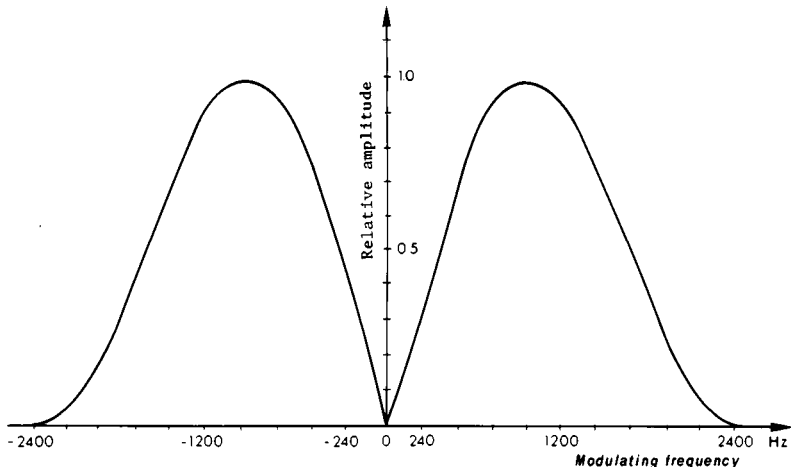

Figure 5: Spectrum of biphase coded radio-data signals

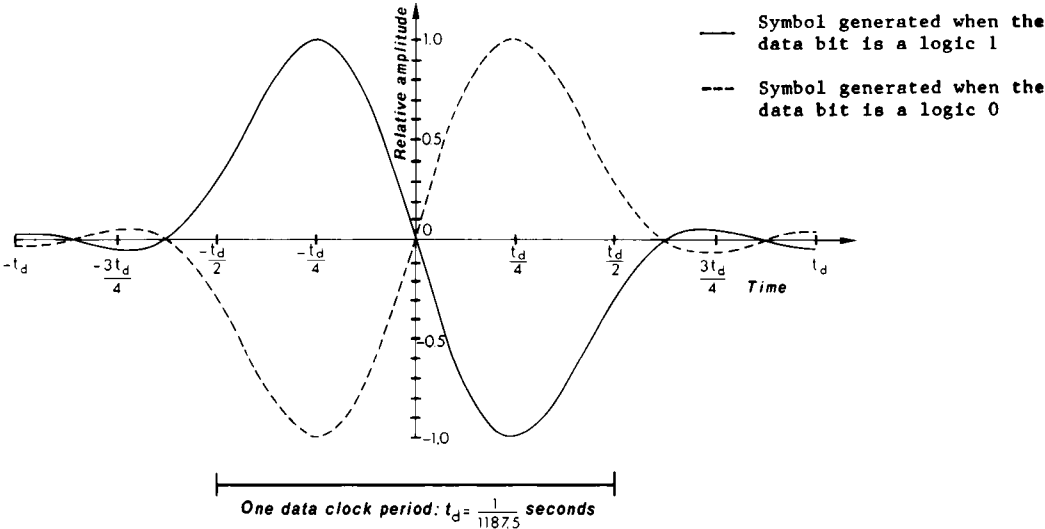

Figure 6: Time-function of a single biphase symbol

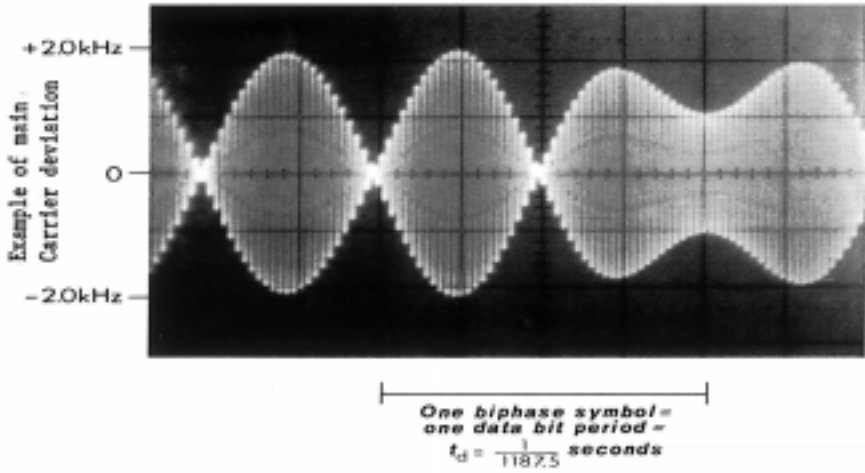

Figure 7: 57 kHz radio-data signals

2 Baseband coding (data-link layer)

2.1 Baseband coding structure

Figure 8 shows the structure of the baseband coding. The largest element in the structure is called a "group" of 104 bits each. Each group comprises 4 blocks of 26 bits each. Each block comprises an information word and a checkword. Each information word comprises 16 bits. Each checkword comprises 10 bits (see 2.3).

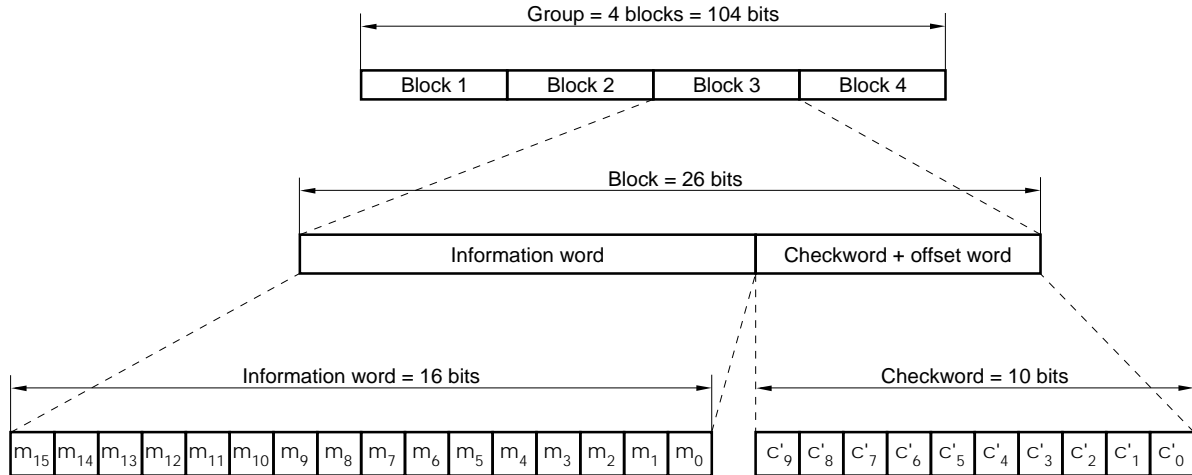

Figure 8: Structure of the baseband coding

For obtaining RDS information from an RDS/MMBS multiplex signal please reference annex P.

2.2 Order of bit transmission

All information words, checkwords, binary numbers or binary address values have their most significant bit (m.s.b.) transmitted first (see figure 9). Thus the last bit transmitted in a binary number or address has weight 2^0 .

The data transmission is fully synchronous and there are no gaps between the groups or blocks.

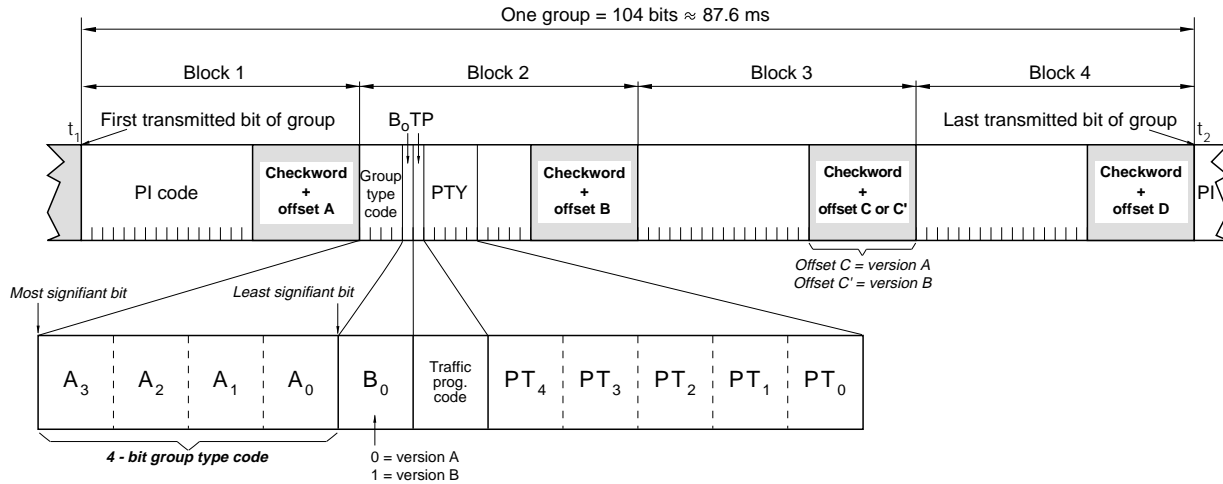

Figure 9: Message format and addressing

Notes to figure 9:

1. Group type code = 4 bits (see 3.1)
2. B₀ = version code = 1 bit (see 3.1)
3. PI code = Program Identification code = 16 bits (see 3.2.1.1 and annex D)
4. TP = Traffic Program Identification code = 1 bit (see 3.2.1.3)
5. PTY = Program Type code = 5 bits (see 3.2.1.2 and annex F)
6. Checkword + offset "N" = 10 bits added to provide error protection and block and group synchronization information (see 2.3 and 2.4 and annexes A, B and C)
7. t₁ < t₂: Block 1 of any particular group is transmitted first and block 4 last

2.3 Error protection

Each transmitted 26-bit block contains a 10-bit checkword which is primarily intended to enable the receiver/decoder to detect and correct errors which occur in transmission. This checkword (i.e. c'₉, c'₈, ... c'₀ in figure 8) is the sum (modulo 2) of:

- a) the remainder after multiplication by x¹⁰ and then division (modulo 2) by the generator polynomial g(x), of the 16-bit information word,
- b) a 10-bit binary string d(x), called the "offset word",

where the generator polynomial, g(x) is given by:

$$g(x) = x^{10} + x^8 + x^7 + x^5 + x^4 + x^3 + 1$$

and where the offset values, d(x), which are different for each block within a group (see 2.4) are given in annex A.

The purpose of adding the offset word is to provide a group and block synchronization system in the receiver/decoder (see 2.4). Because the addition of the offset is reversible in the decoder the normal additive error-correcting and detecting properties of the basic code are unaffected.

The checkword thus generated is transmitted m.s.b. (i.e. the coefficient of c'₉ in the checkword) first and is transmitted at the end of the block which it protects.

The above description of the error protection may be regarded as definitive, but further explanatory notes on the generation and theory of the code are given in annexes B and C .

The error-protecting code has the following error-checking capabilities [3, 4] :

- a) Detects all single and double bit errors in a block.
- b) Detects any single error burst spanning 10 bits or less.
- c) Detects about 99.8% of bursts spanning 11 bits and about 99.9% of all longer bursts.

The code is also an optimal burst error correcting code [5] and is capable of correcting any single burst of span 5 bits or less.

2.4 Synchronization of blocks and groups

The blocks within each group are identified by the offset words A, B, C or C' and D added to blocks 1, 2, 3, and 4 respectively in each group (see annex A).

The beginnings and ends of the data blocks may be recognized in the receiver decoder by using the fact that the error-checking decoder will, with a high level of confidence, detect block synchronization slip as well as additive errors. This system of block synchronization is made reliable by the addition of the offset words (which also serve to identify the blocks within the group). These offset words destroy the cyclic property of the basic code so that in the modified code, cyclic shifts of codewords do not give rise to other codewords [6, 7].

Further explanation of a technique for extracting the block synchronization information at the receiver is given in annex C.

**For obtaining RDS information from an RDS/MMBS multiplex signal the E offset word must be recognized
Please reference annex P.**

3 Message format (session and presentation layers)

3.1 Addressing

3.1.1 Design principles

The basic design principles underlying the message format and addressing structure are as follows:

- a) The messages which are to be repeated most frequently, and for which a short acquisition time is required e.g. Program Identification (PI) codes, in general occupy the same fixed positions within every group. They can therefore be decoded without reference to any block outside the one which contains the information.
- b) There is no fixed rhythm of repetition of the various types of group, i.e. there is ample flexibility to interleave the various kinds of message to suit the needs of the users at any given time and to allow for future developments.
- c) This requires addressing to identify the information content of those blocks which are not dedicated to the high-repetition-rate information.
- d) Each group is, so far as possible, fully addressed to identify the information content of the various blocks.
- e) The mixture of different kinds of message within any one group is minimized, e.g. one group type is reserved for basic tuning information, another for radiotext, etc. This is important so that broadcasters who do not wish to transmit messages of certain kinds are not forced to waste channel capacity by transmitting groups with unused blocks. Instead, they are able to repeat more frequently those group types which contain the messages they want to transmit.
- f) To allow for future applications the data formatting has been made flexible. For example, a number of group types (see table 6) may be used for Open Data Applications (see 3.1.4 and 4.9).

3.1.2 Principal features

The main features of the message structure have been illustrated in figure 9. These may be seen to be:

- 1) The first block in every group always contains a Program Identification (PI) code.
- 2) The first four bits of the second block of every group are allocated to a four-bit code which specifies the application of the group. Groups will be referred to as types 0 to 15 according to the binary weighting $A_3=8, A_2=4, A_1=2, A_0=1$ (see figure 9). For each type (0 to 15) two "versions" can be defined. The "version" is specified by the fifth bit (B_0) of block 2 as follows:
 - a) $B_0 = 0$: the PI code is inserted in block 1 only. This will be called version A, e.g. 0A, 1A, etc.
 - b) $B_0 = 1$: the PI code is inserted in block 1 and block 3 of all group types. This will be called version B, e.g. 0B, 1B, etc.

In general, any mixture of type A and B groups may be transmitted.

- 3) The Program Type code (PTY) and Traffic Program identification (TP) occupy fixed locations in block 2 of every group.

The PI, PTY and TP codes can be decoded without reference to any block outside the one that contains the information. This is essential to minimize acquisition time for these kinds of message and to retain the advantages of the short (26-bit) block length. To permit this to be done for the PI codes in block 3 of version B groups, a special offset word (which we shall call C') is used in block 3 of version B groups. The occurrence of offset C' in block 3 of any group can then be used to indicate directly that block 3 is a PI code, without any reference to the value of B_0 in block 2.

3.1.3 Group types

It was described above (see also figure 9) that the first five bits of the second block of every group are allocated to a five-bit code which specifies the application of the group and its version, as shown in table 3. **The group sequencing for a multiplex of RDS/MMBS is given in annex P.4.**

Table 3: Group types

Group type	Group type code/version					Flagged in type 1A groups	Description
	A ₃	A ₂	A ₁	A ₀	B ₀		
0 A	0	0	0	0	0		Basic tuning and switching information only (see 3.1.5.1)
0 B	0	0	0	0	1		Basic tuning and switching information only (see 3.1.5.1)
1 A	0	0	0	1	0		Program Item Number and slow labeling codes only (see 3.1.5.2)
1 B	0	0	0	1	1		Program Item Number (see 3.1.5.2)
2 A	0	0	1	0	0		RadioText only (see 3.1.5.3)
2 B	0	0	1	0	1		RadioText only (see 3.1.5.3)
3 A	0	0	1	1	0		Applications Identification for ODA only (see 3.1.5.5)
3 B	0	0	1	1	1		Open Data Applications
4 A	0	1	0	0	0		Clock-time and date only (see 3.1.5.6)
4 B	0	1	0	0	1		Open Data Applications
5 A	0	1	0	1	0		Transparent Data Channels (32 channels) or ODA (see 3.1.5.8)
5 B	0	1	0	1	1		Transparent Data Channels (32 channels) or ODA (see 3.1.5.8)
6 A	0	1	1	0	0		In House applications or ODA (see 3.1.5.9)
6 B	0	1	1	0	1		In House applications or ODA (see 3.1.5.9)
7 A	0	1	1	1	0	Y	Radio Paging or ODA (see 3.1.5.10 and annex M)
7 B	0	1	1	1	1		Open Data Applications
8 A	1	0	0	0	0	Y	Traffic Message Channel or ODA (see 3.1.5.12)
8 B	1	0	0	0	1		Open Data Applications
9 A	1	0	0	1	0	Y	Emergency Warning System or ODA (see 3.1.5.13)
9 B	1	0	0	1	1		Open Data Applications
10 A	1	0	1	0	0		Program Type Name
10 B	1	0	1	0	1		Open Data Applications
11 A	1	0	1	1	0		Open Data Applications
11 B	1	0	1	1	1		Open Data Applications
12 A	1	1	0	0	0		Open Data Applications
12 B	1	1	0	0	1		Open Data Applications
13 A	1	1	0	1	0	Y	Enhanced Radio Paging or ODA (see annex M)
13 B	1	1	0	1	1		Open Data Applications
14 A	1	1	1	0	0		Enhanced Other Networks information only (see 3.1.5.19)
14 B	1	1	1	0	1		Enhanced Other Networks information only (see 3.1.5.19)
15 A	1	1	1	1	0		Defined in RBDS only
15 B	1	1	1	1	1		Fast switching information only (see 3.1.5.20)

The appropriate repetition rates for some of the main features are indicated in table 4:

Table 4: Main feature repetition rates

Main Features	Group types which contain this information	Appropriate repetition rate per sec.
Program Identification (PI) code	all	11.4 ¹
Program Type (PTY) code	all	11.4 ¹
Traffic Program (TP) identification code	all	11.4 ¹
Program Service (PS) name ⁴⁾	0A, 0B	1
Alternative frequency (AF) code pairs	0A	4
Traffic announcement (TA) code	0A, 0B, 14B, 15B	4
Decoder identification (DI) code	0A, 0B, 15B	1
Music/speech (M/S) code	0A, 0B, 15B	4
Radiotext (RT) message	2A, 2B	0.2 ²
Enhanced other networks information (EON)	14A	up to 2 ³

¹ Valid codes for this item will normally be transmitted with at least this repetition rate whenever the transmitter carries a normal broadcast program.
² A total of 16 type 2A groups are required to transmit a 64 character radiotext message and therefore to transmit this message in 5 seconds, 3.2 type 2A groups will be required per second.
³ The maximum cycle time for the transmission of all data relating to all cross-referenced program services shall be less than 2 minutes.
⁴ PS must only be used for identifying the program service and it must not be used for other messages giving sequential information.

A total of four type 0A groups are required to transmit the entire PS name and therefore four type 0A groups will be required per second. The repetition rate of the type 0A group may be reduced if more capacity is needed for other applications. But a minimum of two type 0A groups per second is necessary to ensure correct functioning of PS and AF features. However, with EON receivers search tuning is affected by the repetition rate of type 0 groups (TP/TA, see 3.2.1.3). It must be noted that in this case transmission of the complete PS will take 2 seconds. However, under typical reception conditions the introduction of errors will cause the receiver to take 4 seconds or more to acquire the PS name for display.

The following mixture of groups is suitable to meet the repetition rates noted above.

Table 5: Group repetition rates

Group types	Features	Typical proportion of groups of this type transmitted
0A or 0B	PI, PS, PTY, TP, AF ¹⁾ , TA, DI, M/S	40%
1A or 1B	PI, PTY, TP, PIN	10%
2A or 2B	PI, PTY, TP, RT	15% ²
14A or 14B	PI, PTY, TP, EON	10%
Any other	Other applications	25%

¹ Type 0A group only
² Assuming that type 2A groups are used to transmit a 32-character radiotext message. A mixture of type 2A and 2B groups in any given message should be avoided (see 3.1.5.3)

3.1.4 Open data channel / Applications Identification

3.1.4.1 Use of Open Data Applications

Open Data Applications (ODA) are not explicitly specified in this standard. They are subject to a registration process and registered applications are listed in the EBU/RDS Forum - ODA Directory (see annex L), which references appropriate standards and normative specifications. These specifications may however be public (specification in the public domain) or private (specification not in the public domain). The terms public and private do not imply the degree of access to services provided by an application, for example a public service may include encryption.

An ODA may use type A and/or type B groups, however it must not be designed to operate with a specific group type. The specific group type used by the ODA in any particular transmission is signaled in the Applications Identification (AID) carried in type 3A groups (see 3.1.5.4). Table 6 shows the type A and type B groups that may be allocated to ODA. Group types not shown in table 6 are not available for ODA.

Table 6: ODA group availability signaled in type 3A groups

Group type	Application group type code	Availability for Open Data Applications
	00000	Special meaning: Not carried in associated group
3B	00111	Available unconditionally
4B	01001	Available unconditionally
5A	01010	Available when not used for TDC
5B	01011	Available when not used for TDC
6A	01100	Available when not used for IH
6B	01101	Available when not used for IH
7A	01110	Available when not used for RP
7B	01111	Available unconditionally
8A	10000	Available when not used for TMC
8B	10001	Available unconditionally
9A	10010	Available when not used for EWS
9B	10011	Available unconditionally
10B	10101	Available unconditionally
11A	10110	Available unconditionally
11B	10111	Available unconditionally
12A	11000	Available unconditionally
12B	11001	Available unconditionally
13A	11010	Available when not used for RP
13B	11011	Available unconditionally
	11111	Special meaning: Temporary data fault (Encoder status)

3.1.4.2 Open Data Applications - Group structure

Open Data Applications must use the format shown in figure 10 for ODA type A groups and in figure 11 for ODA type B groups.

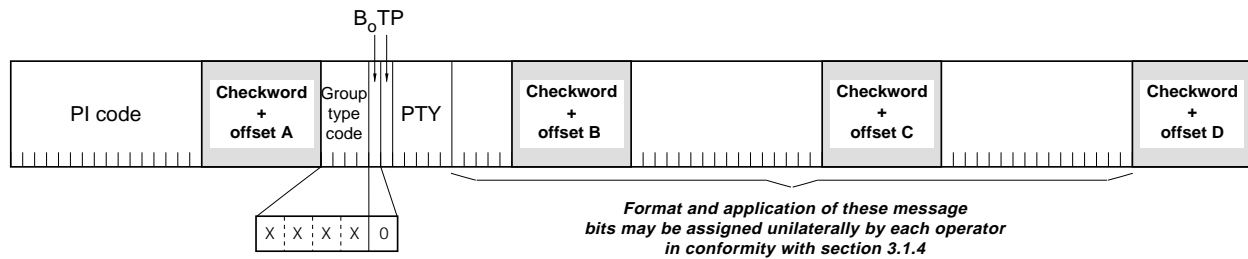

Figure 10: ODA type A groups

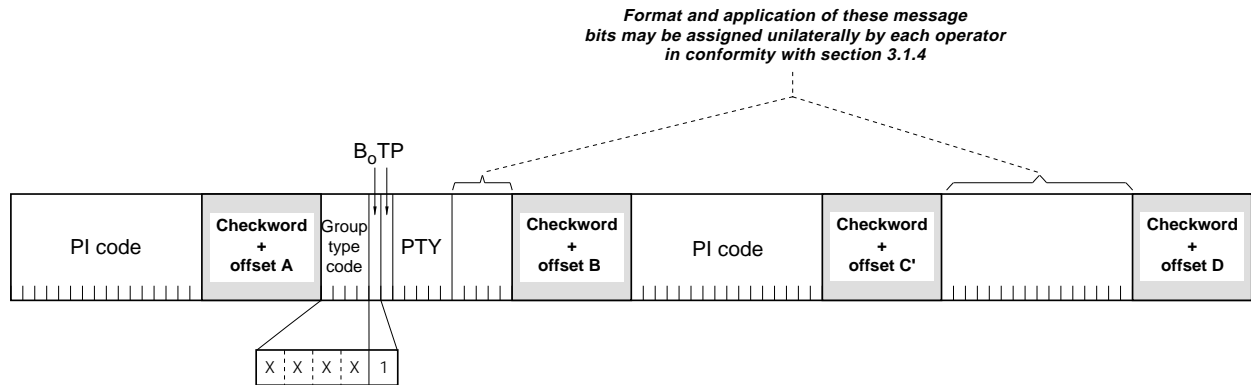

Figure 11: ODA type B groups

3.1.5 Coding of the Group types

3.1.5.1 Type 0 groups: Basic tuning and switching information

The repetition rates of type 0 groups must be chosen in compliance with 3.1.3.

Figure 12 shows the format of type 0A groups and figure 13 the format of type 0B groups.

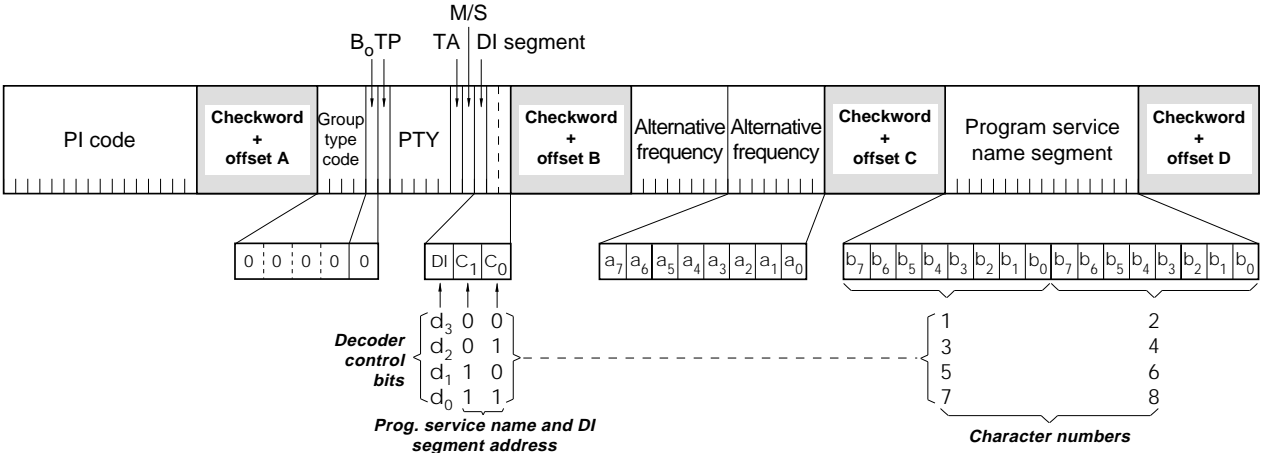

Figure 12: Basic tuning and switching information - Type 0A group

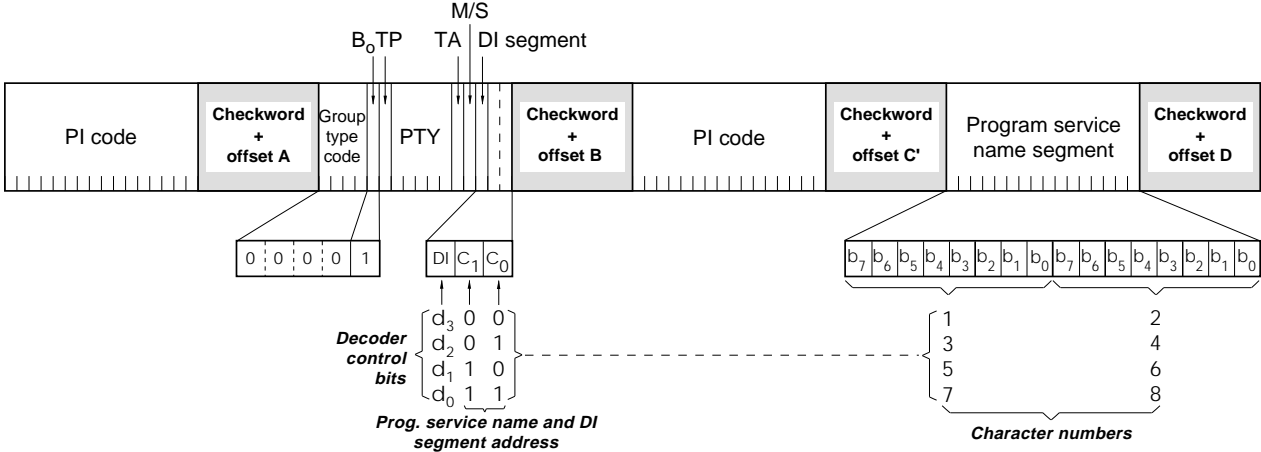

Figure 13: Basic tuning and switching information - Type 0B group

Type 0A groups are usually transmitted whenever alternative frequencies exist. Type 0B groups without any type 0A groups may be transmitted only when no alternative frequencies exist.

There are two methods (A and B) for transmission of alternative frequencies (see 3.2.1.6.2).

The Program Service name comprises eight characters. It is the primary aid to listeners in program service identification and selection. The Program Service name is to be used only to identify the station or station program. This text may be changed as required by the station, but shall not be scrolled or flashed or altered in a manner that would be disturbing or distracting to the viewer (i.e. not more frequently than once per minute).

Notes on Type 0 groups:

1. *Version B differs from version A only in the contents of block 3, the offset word in block 3, and, of course, the version code B_0*
2. *For details of Program Identification (PI), Program Type (PTY) and Traffic Program (TP) code, see figure 9, 3.2.1 and annexes D and F.*
3. *TA = Traffic announcement code (1 bit) (see 3.2.1.3).*
4. *M/S = Music-speech switch code (1 bit) (see 3.2.1.4).*
5. *DI = Decoder-identification control code (4 bits) (see 3.2.1.5). This code is transmitted as 1 bit in each type 0 group. The Program Service name and DI segment address code (C_1 and C_0) serves to locate these bits in the DI codeword. Thus in a group with $C_1C_0 = "00"$ the DI bit in that group is d_3 . These code bits are transmitted most significant bit (d_3) first.*
6. *Alternative frequency codes (2 x 8 bits) (see 3.2.1.6).*
7. *Program Service name (for display) is transmitted as 8-bit character as defined in the 8-bit code-tables in annex E. Eight characters (including spaces) are allowed for each network and are transmitted as a 2-character segment in each type 0 group. These segments are located in the displayed name by the code bits C_1 and C_0 in block 2. The addresses of the characters increase from left to right in the display. The most significant bit (b_7) of each character is transmitted first.*

3.1.5.2 Type 1 groups: Program Item Number and slow labeling codes

Figure 14 shows the format of type 1A groups and figure 15 the format of type 1B groups.

When a Program Item Number is changed, a type 1 group should be repeated four times with a separation of about 0.5 seconds. The unused bits in block 2 (type 1B only) are reserved for future applications.

Where Radio Paging is implemented in RDS, a type 1A group will be transmitted in an invariable sequence, regularly once per second, except at each full minute, where it is replaced by one type 4A group.

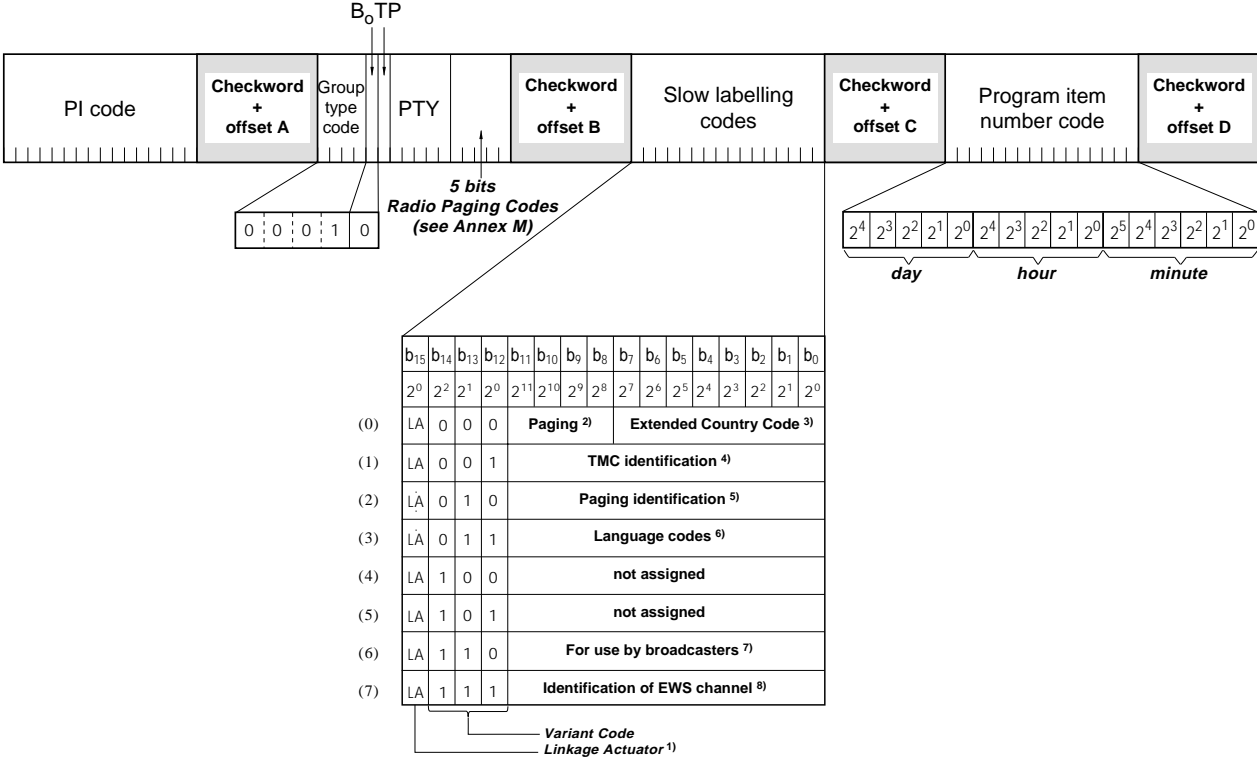

¹⁾ The Linkage Actuator is defined in the "Method for Linking RDS Program Services" (see 3.2.1.8.3).
²⁾ Normally set to zero except when used for the OPERator Code in Radio Paging with the Enhanced Paging Protocol, defined in annex M (see M.3.2.2 and M.3.2.4).
³⁾ Extended country codes are defined separately (see annex D).
⁴⁾ TMC system information is separately specified by the CEN standard ENV 12313-1 (see 3.1.5.12). This identification is not required if ODA is used for coding TMC.
⁵⁾ The Paging Identification is defined in the "Multi Operator / Area paging" section (see annex M).
⁶⁾ Language codes are defined separately (see annex J).
⁷⁾ The coding of this information may be decided unilaterally by the broadcaster to suit the application. RDS consumer receivers should entirely ignore this information.
⁸⁾ The Emergency Warning Systems (EWS) are defined separately (see 3.2.7).

Figure 14: Program Item Number and slow labeling codes - Type 1A group

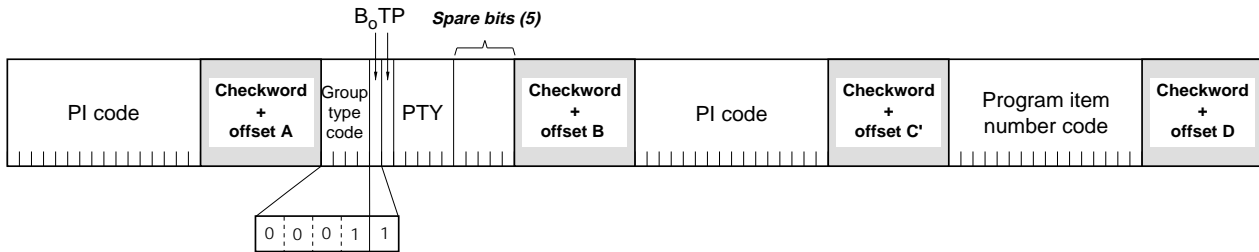

Figure 15: Program Item Number - Type 1B group

Notes on Type 1 groups:

1. Version B differs from version A in the contents of blocks 2 and 3, the offset word in block 3, and, of course, the version code B₀.
2. The Program Item Number is the scheduled broadcast start time and day of month as published by the broadcaster. The day of month is transmitted as a five-bit binary number in the range 1-31. Hours are transmitted as a five-bit binary number in the range 0-23. The spare codes are not used. Minutes are transmitted as a six-bit binary number in the range 0-59. The spare codes are not used.
3. The most significant five bits in block 4 which convey the day of the month, if set to zero, indicate that no valid Program Item Number is being transmitted. In this case, if no Radio Paging is implemented, the remaining bits in block 4 are undefined. However, in the case of type 1A groups only, if Enhanced Radio Paging is implemented, the remaining bits carry Service Information (see annex M).
4. Bits b14, b13 and b12 of block 3 of version A form the variant code, which determines the application of data carried in bits b11 to b0. A broadcaster may use as many or as few of the variant codes as wished, in any proportion and order.

3.1.5.3 Type 2 groups: Radiotext

Figure 16 shows the format of type 2A groups and figure 17 the format of type 2B groups.

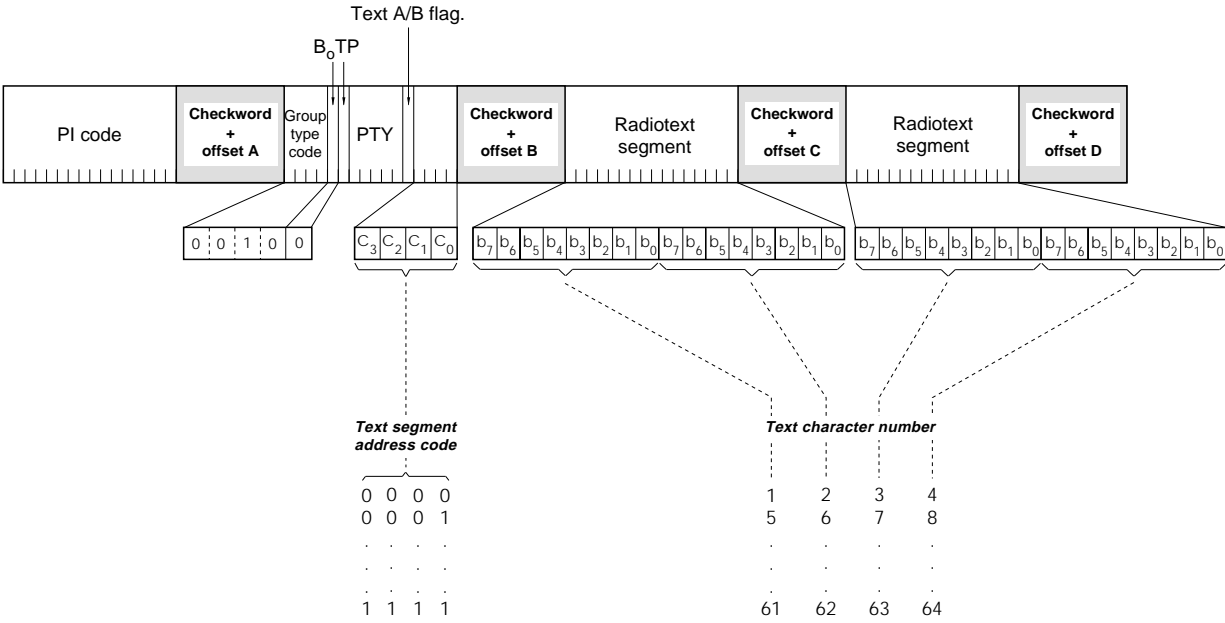

Figure 16: Radiotext - Type 2A group

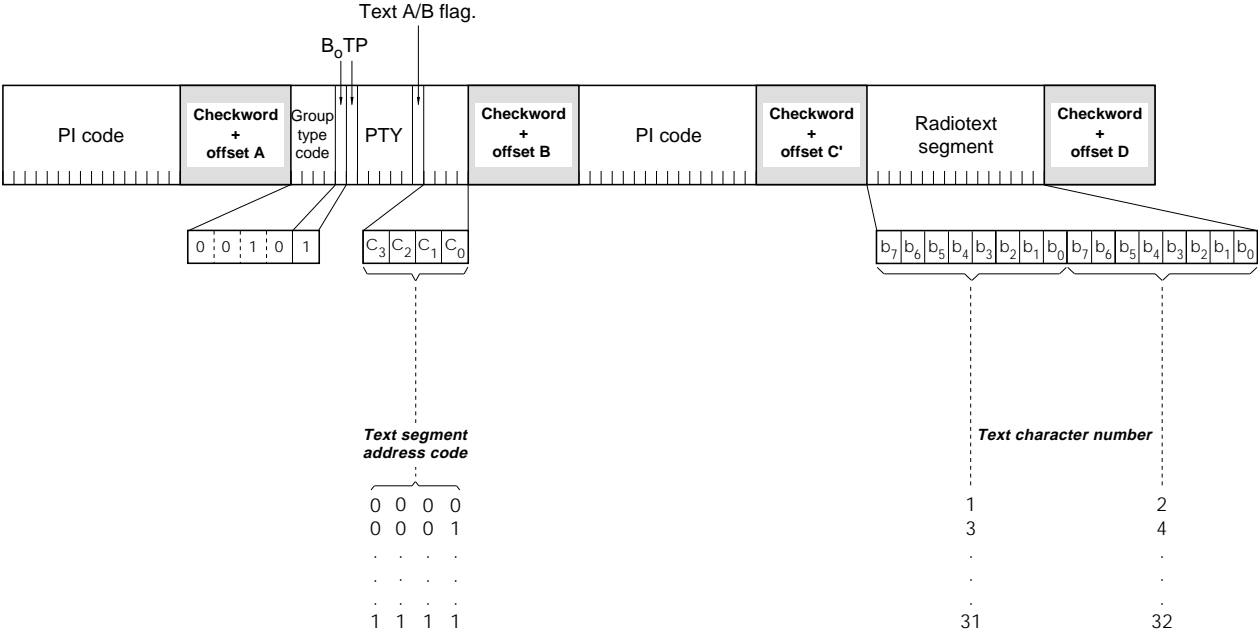

Figure 17: Radiotext - Type 2B group

The 4-bit text segment address defines in the current text the position of the text segments contained in the third (version A only) and fourth blocks. Since each text segment in version 2A groups comprises four characters, messages of up to 64 characters in length can be sent using this version. In version 2B groups, each text segment comprises only two characters and therefore when using this version the maximum message length is 32 characters.

A new text must start with segment address "0000" and there must be no gaps up to the highest used segment address of the current message. The number of text segments is determined by the length of the message, and each message should be ended by the code 0D (Hex) - carriage return - if the current message requires less than 16 segment addresses.

If a display which has fewer than 64 characters is used to display the radiotext message then memory should be provided in the receiver/decoder so that elements of the message can be displayed sequentially. This may, for example, be done by displaying elements of text one at a time in sequence, or, alternatively by scrolling the displayed characters of the message from right to left.

Code 0A (Hex) - line feed - may be inserted to indicate a preferred line break.

It should be noted that because of the above considerations there is possible ambiguity between the addresses contained in version A and those contained in version B. For this reason a mixture of type 2A and type 2B groups must not be used when transmitting any one given message.

- An important feature of type 2 groups is the Text A/B flag contained in the second block. Two cases occur:

If the receiver detects a change in the flag (from binary "0" to binary "1" or vice-versa), then the whole radiotext display should be cleared and the newly received radiotext message segments should be written into the display.
- If the receiver detects no change in the flag, then the received text segments or characters should be written into the existing displayed message and those segments or characters for which no update is received should be left unchanged.

When this application is used to transmit a 32-character message, at least three type 2A groups or at least six type 2B groups should be transmitted in every two seconds.

It may be found from experience that all radiotext messages should be transmitted at least twice to improve reception reliability.

Notes on Type 2 groups:

1. Radiotext is transmitted as 8-bit characters as defined in the 8-bit code-tables in annex E. The most significant bit (b_7) of each character is transmitted first.
2. The addresses of the characters increase from left to right in the display.

3.1.5.4 Type 3A groups: Application identification for Open data

Figure 18 shows the format of type 3A groups. These groups are used to identify the Open Data Application in use, on an RDS transmission (see 3.1.4).

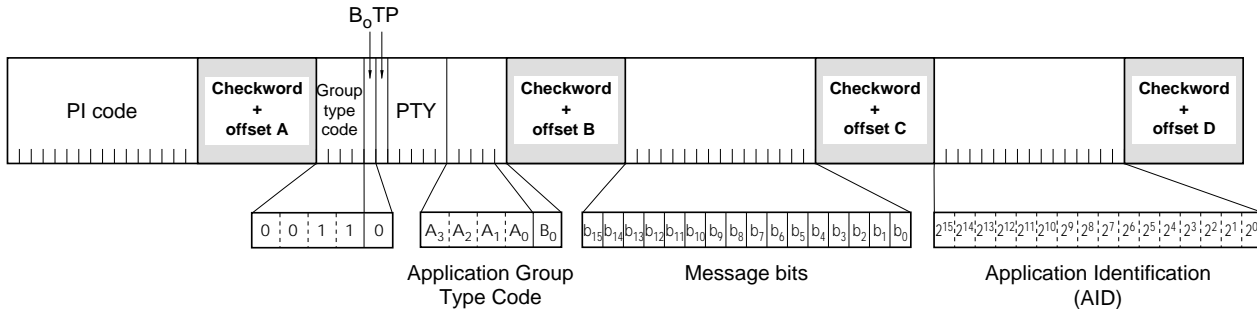

Figure 18: Application Identification for Open data - Type 3A group

The type 3A group conveys, to a receiver, information about which Open Data Applications are carried on a particular transmission and in which groups they will be found. The type 3A group comprises three elements: the Application Group type code used by that application, 16 message bits for the actual ODA and the Applications Identification (AID) code. Applications which actively utilize both, type A and B groups, are signaled using two type 3A groups.

The Application Group type code indicates the group type used, in the particular transmission, to carry the specified ODA. Table 6 specifies the permitted group types. The bit designation is as per figure 9, 4-bit for group type code and 1-bit for the group type version. Two special conditions may be indicated: 00000 - Not carried in associated group; 11111 - Temporary data fault (Encoder status) which means that incoming data to the encoder cannot be transmitted. The AID determines which software handler a receiver needs to use.

This supplements information carried in the type 1A group and permits groups specified in this standard for EWS, IH, RP and TMC to be re-allocated when these features are not used. This method of allocating and defining Open Data Applications in an RDS transmission allows the addition and subtraction of ODAs, without constraint or the need to await the publication of new standards.

For each group type addressed by the Application Group Type codes of a particular transmission, only one application may be identified as the current user of the channel.

The AID code 0000 (Hex) may be used to indicate that the respective group type is being used for the normal feature specified in this standard. Application Identification codes 0001 to FFFF (Hex) indicate applications as specified in the ODA Directory.

The ODA Directory specification associated with a particular AID code defines the use of type A and type B groups as follows:

- type A groups used alone (mode 1.1)
- type B groups used alone (mode 1.2)
- type A groups and type B groups used as alternatives (mode 2)
- type A groups and type B groups used together (mode 3)

It is important to note that the ODA Directory specification must not specify the actual type A and type B groups to be used, since these are assigned in each transmission by the type 3A group.

The AID feature indicates that a particular ODA is being carried in a transmission. Each application will have unique requirements for transmission of its respective AID, in terms of repetition rate and timing. These requirements must be detailed in the respective ODA specification. The specification must also detail the AID signaling requirements for such times when an application assumes or loses the use of a group type channel.

Some applications may not allow reconfiguration in this way.

3.1.5.5 Type 3B groups: Open Data Application

Figure 19 shows the format of type 3B groups. These groups are usable for Open Data (see 3.1.4).

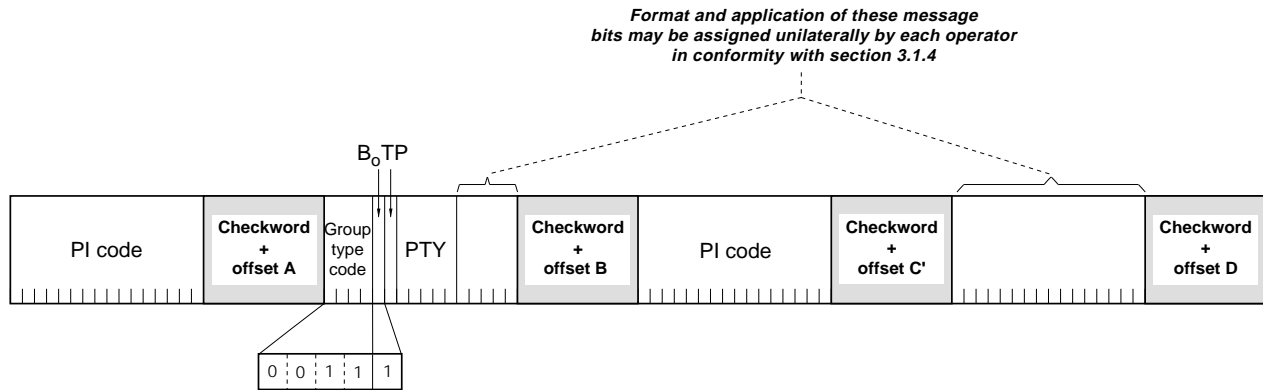

Figure 19: Open data - Type 3B group

3.1.5.6 Type 4A groups : Clock-time and date

The transmitted clock-time and date shall be accurately set to UTC plus local offset time. Otherwise the transmitted CT codes shall all be set to zero.

Figure 20 shows the format of type 4A groups.

When this application is used, one type 4A group will be transmitted every minute.

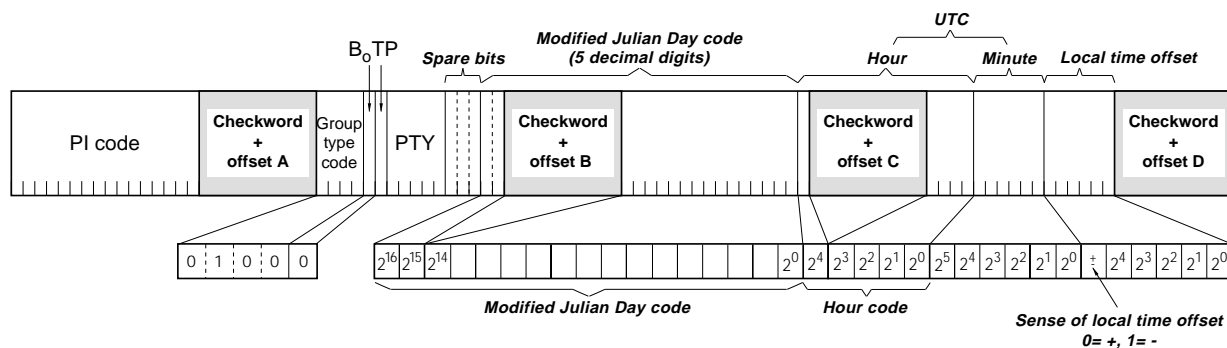

Figure 20: Clock-time and date transmission - Type 4A group

Notes on Type 4A groups:

1. The local time is composed of Coordinated Universal Time (UTC) plus local time offset.
2. The local time offset is **expressed in multiples of half hours** within the range -12 h to +12 h and is coded as a six-bit binary number. "0" = positive offset (East of zero degree longitude), and "1" = negative offset (West of zero degrees longitude).
3. The information relates to the epoch immediately following the start of the next group.

4. The Clock time group is inserted so that the minute edge will occur within ± 0.1 seconds of the end of the Clock time group.
5. Minutes are coded as a six-bit binary number in the range 0-59. The spare codes are not used.
6. Hours are coded as five-bit binary number in the range 0-23. The spare codes are not used.
7. The date is expressed in terms of Modified Julian Day and coded as a 17-bit binary number in the range 0-99999. Simple conversion formulas to month and day, or to week number and day of week are given in annex G. Note that the Modified Julian Day date changes at UTC midnight, **not** at local midnight.
8. Accurate CT based on UTC plus local time offset must be implemented on the transmission where TMC and/or Radio paging is implemented.

3.1.5.7 Type 4B groups: Open data application

Figure 21 shows the format of type 4B groups. These groups are usable for Open data (see 3.1.4).

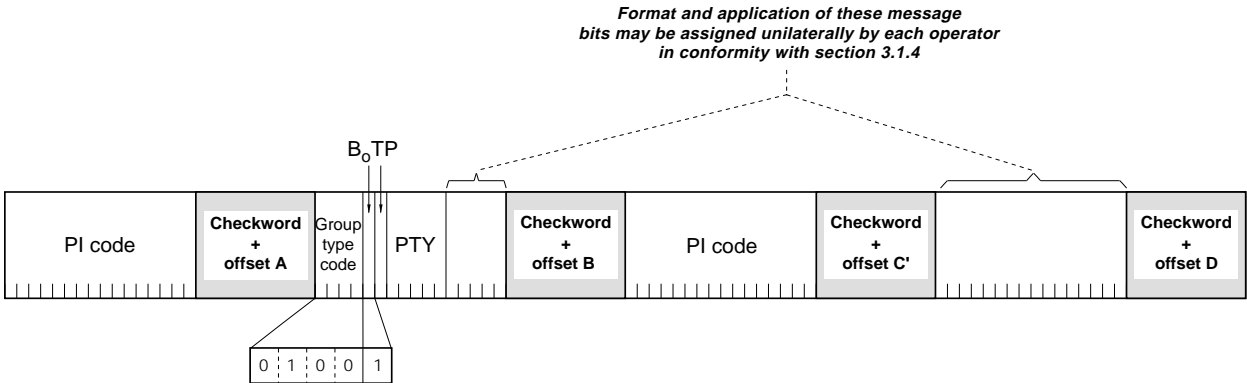

Figure 21: Open data - Type 4B group

3.1.5.8 Type 5 groups: Transparent data channels or ODA

Figure 22 shows the format of type 5A groups and figure 23 the format of type 5B groups, where used for TDC; if used for ODA see 3.1.4.2.

The 5-bit address-code in the second block identifies the "channel-number" (out of 32) to which the data contained in blocks 3 (version A only) and 4 are addressed. Unlike the fixed-format radiotext of type 2 groups, messages of any length and format can be sent using these channels. Display control characters (such as line-feed and carriage-return) will, of course, be sent along with the data.

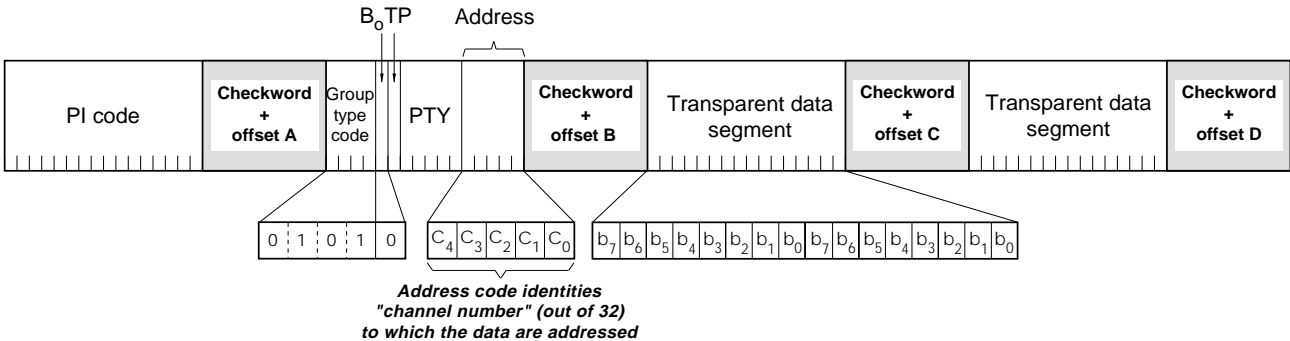

Figure 22: Transparent data channels - Type 5A group

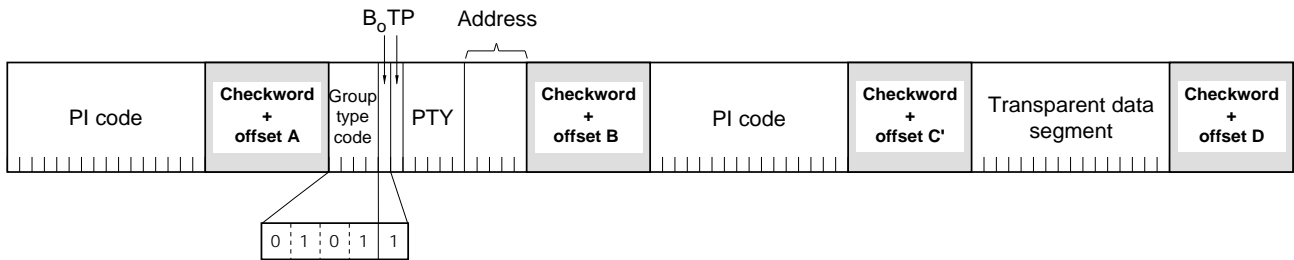

Figure 23: Transparent data channels - Type 5B group

These channels may be used to send alphanumeric characters, or other text (including mosaic graphics), or for transmission of computer programs and similar data not for display. Details of implementation of these last options are to be specified later.

The repetition rate of these group types may be chosen to suit the application and the available channel capacity at the time.

3.1.5.9 Type 6 groups: In-house applications or ODA

Figure 24 shows the format of type 6A groups and the format of type 6B groups, where used for IH; if used for ODA see 3.1.4.2. The contents of the unreserved bits in these groups may be defined unilaterally by the operator.

Consumer receivers should ignore the in-house information coded in these groups. The repetition rate of these group types may be chosen to suit the application and the available channel capacity at the time.

Type 6A group:

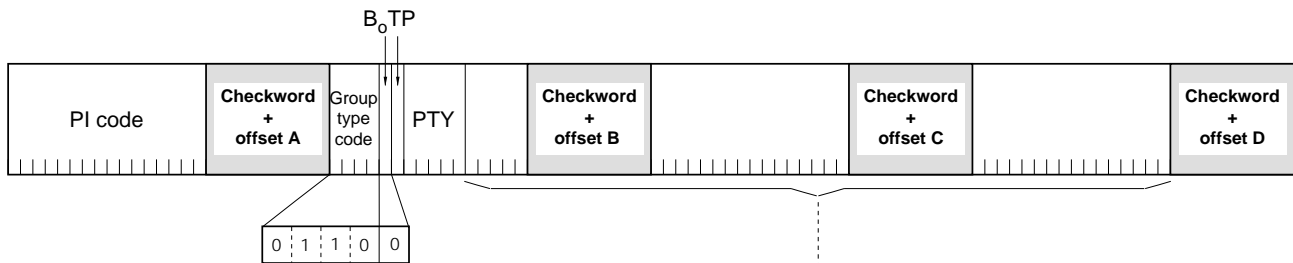

Format and application of these message bits may be assigned unilaterally by each operator

Type 6B group:

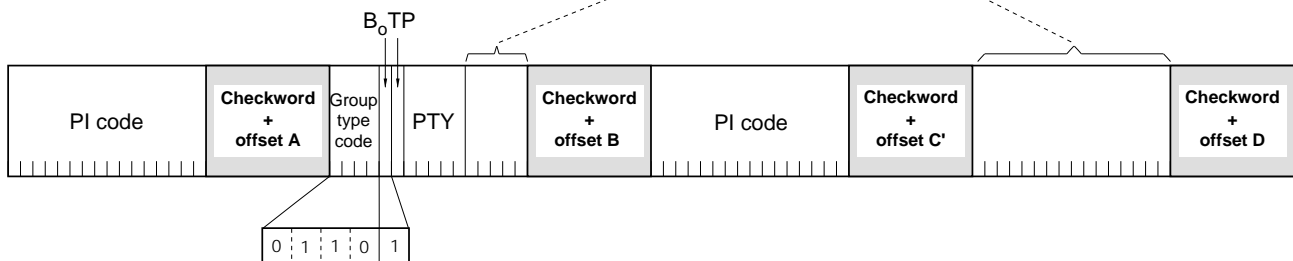

Figure 24: In-house applications - Type 6A and 6B group

3.1.5.10 Type 7A groups: Radio Paging or ODA

Figure 25 shows the format of type 7A groups, where used for Radio Paging; if used for ODA see 3.1.4.2. The specification of RP which also makes use of type 1A, 4A and 13A groups, is given in annex M.

For coding of MMBS radio paging please see annex P.

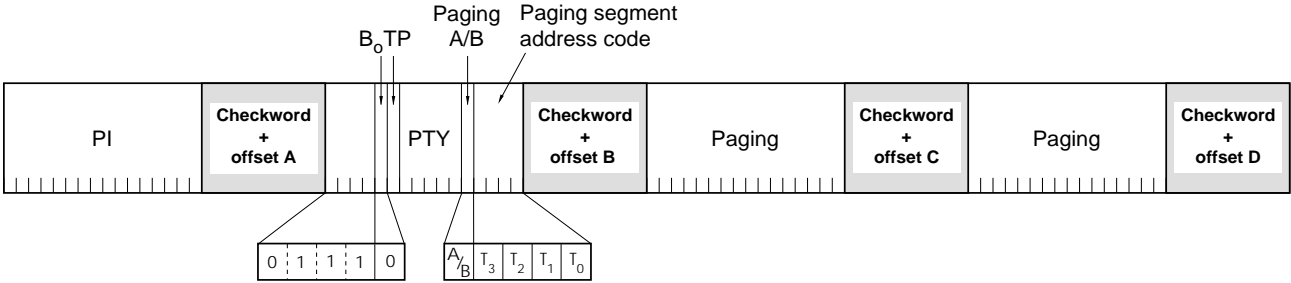

Figure 25: Radio Paging - Type 7A group

3.1.5.11 Type 7B groups: Open data application

Figure 26 shows the format of type 7B groups. These groups are usable for Open data (see 3.1.4).

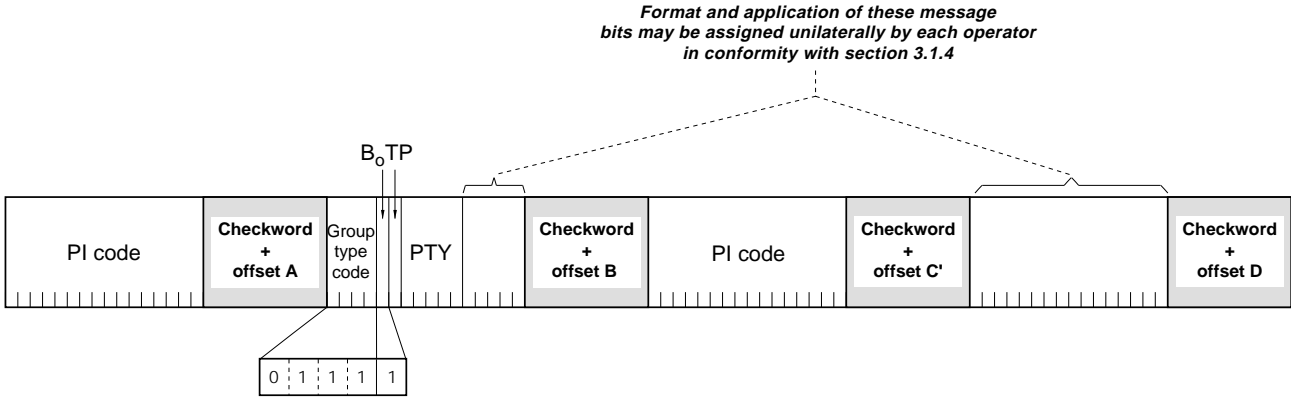

Figure 26: Type 7B group

3.1.5.12 Type 8 groups: Traffic Message Channel or ODA

Figure 27 shows the format of type 8A groups, where used for Traffic Message Channel (TMC); if used for ODA see 3.1.4.2. This group carries the TMC messages. The specification for TMC, using the so called ALERT C protocol also makes use of type 1A and/or type 3A groups together with 4A groups and is separately specified by the CEN standard ENV 12313-1.

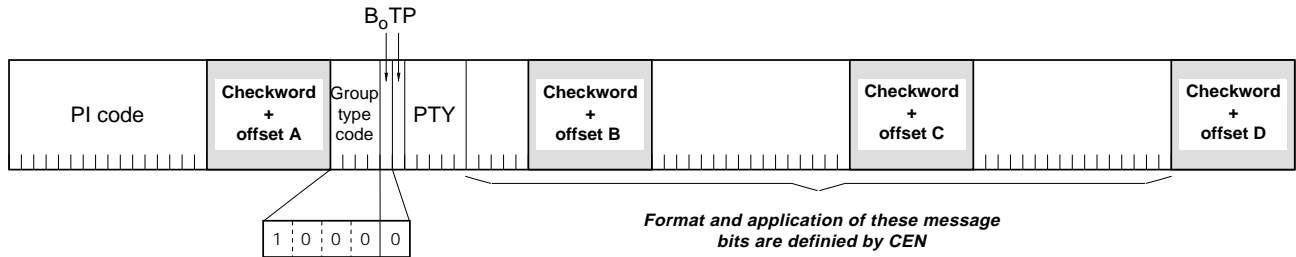

Figure 27: Traffic Message Channel - Type 8A group

Figure 28 shows the format of type 8B groups. These groups are usable for Open data (see 3.1.4).

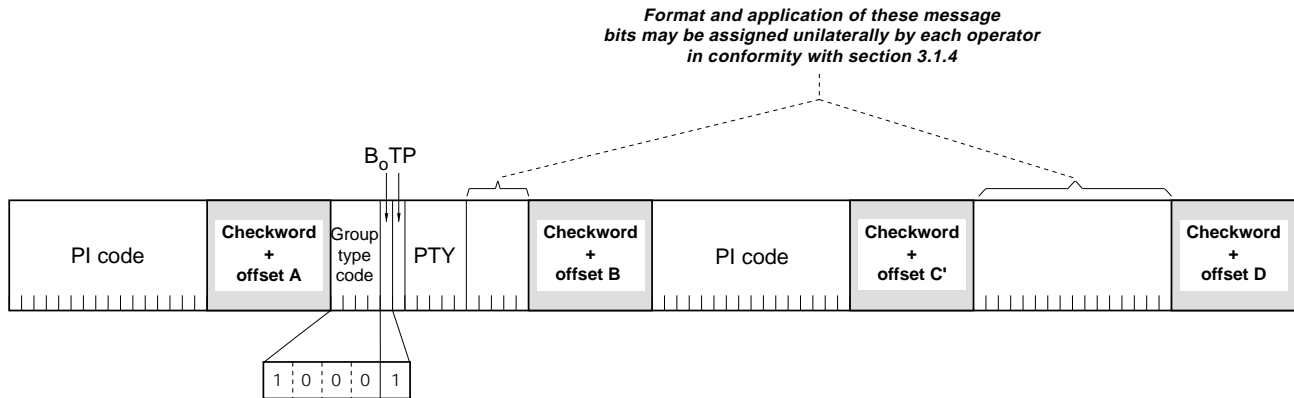

Figure 28: Open data - Type 8B group

3.1.5.13 Type 9 groups: Emergency warning systems or ODA

These groups are transmitted very infrequently, unless an emergency occurs or test transmissions are required. Figure 29 shows the format of type 9A groups where used for EWS; if used for ODA, see 3.1.4.2.

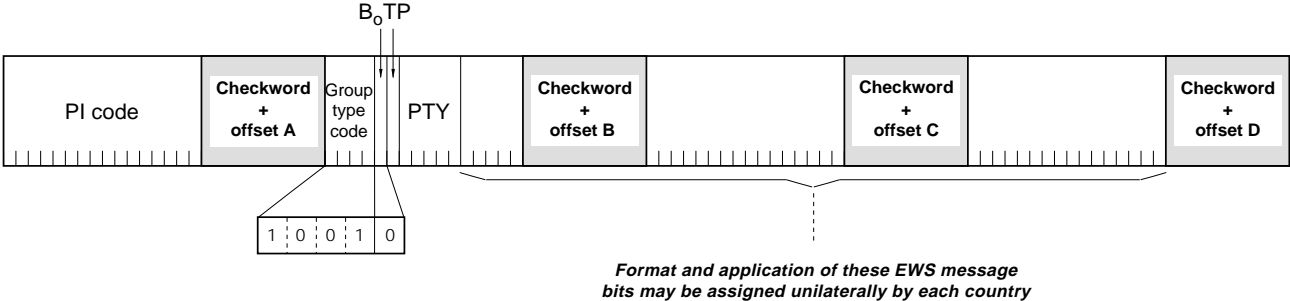

Figure 29: Allocation of EWS message bits - Type 9A group

Format and application of the bits allocated for EWS messages may be assigned unilaterally by each country. However the ECC feature must be transmitted in type 1A groups when EWS is implemented.

Figure 30 shows the format of type 9B groups. These groups are usable for Open data (see 3.1.4).

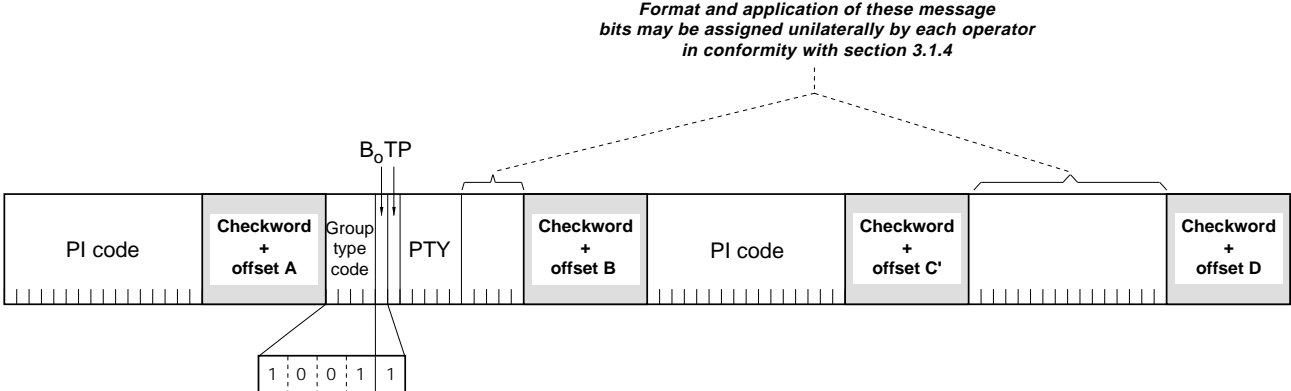

Figure 30: Open data - Type 9B group

3.1.5.14 Type 10 groups: Program Type Name (Group type 10A) and Open data (Group type 10B)

Figure 31 shows the format of type 10A groups used for PTYN.

The type 10A group allows further description of the current Program Type, for example, when using the PTY code 4: SPORT, a PTYN of "Football" may be indicated to give more detail about that program. PTYN must only be used to enhance Program Type information and it must not be used for sequential information.

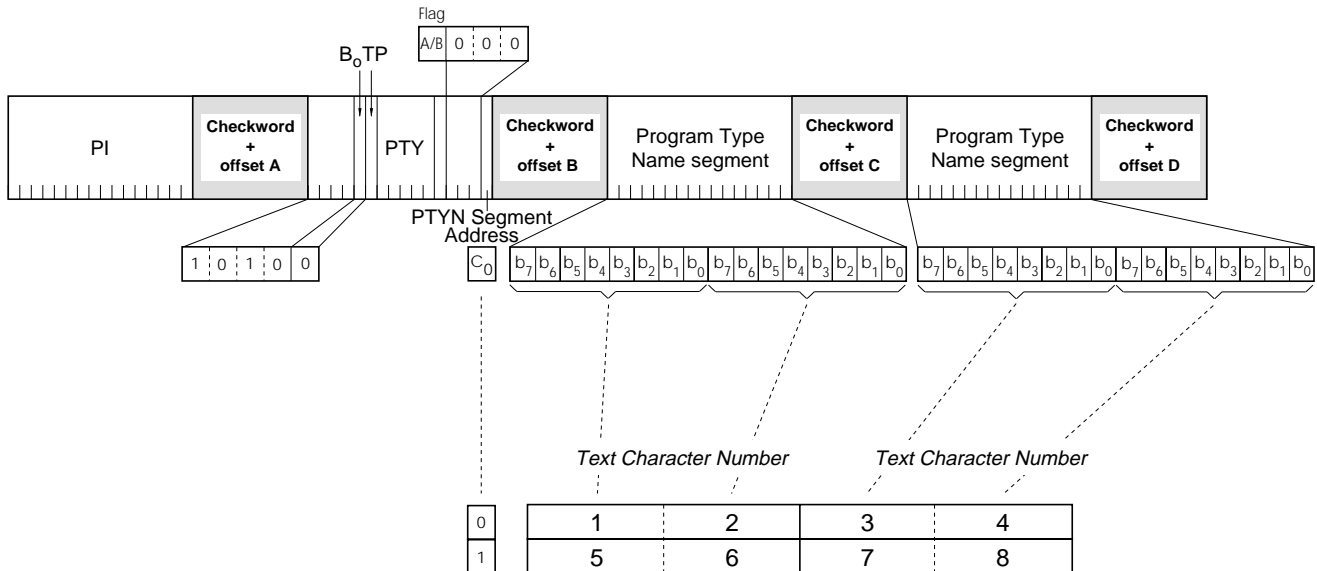

Figure 31: Program Type Name PTYN - Type 10A group

Notes on Type 10A groups:

1. The A/B flag is toggled when a change is made in the PTYN being broadcast.
2. Program Type Name (PTYN) (for display) is transmitted as 8-bit characters as defined in the 8-bit code tables in annex E. Eight characters (including spaces) are allowed for each PTYN and are transmitted as four character segments in each type 10A group. These segments are located in the displayed PTY name by the code bit C₀ in block 2. The addresses of the characters increase from left to right in the display. The most significant bit (b₇) of each character is transmitted first.

Figure 32 shows the format of type 10B groups used for ODA, see 3.1.4.2.

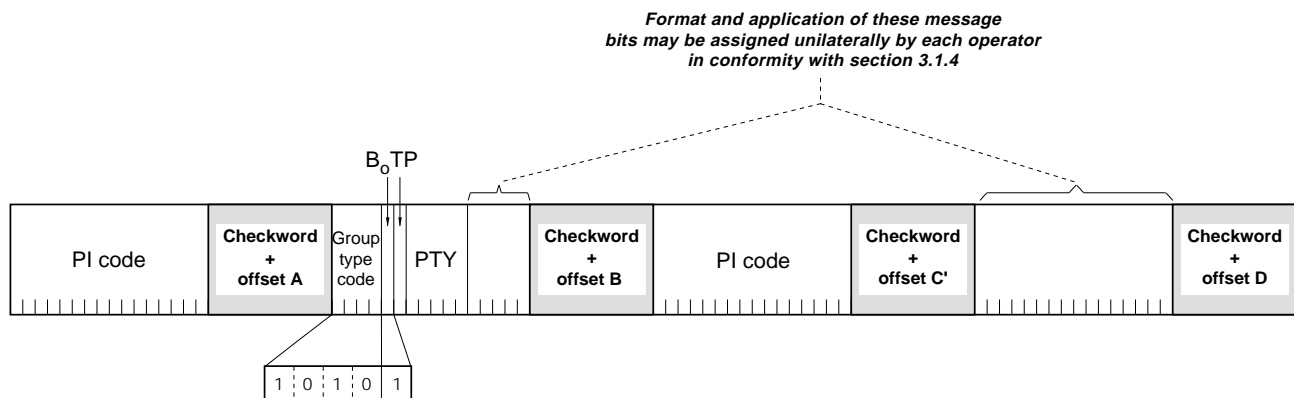
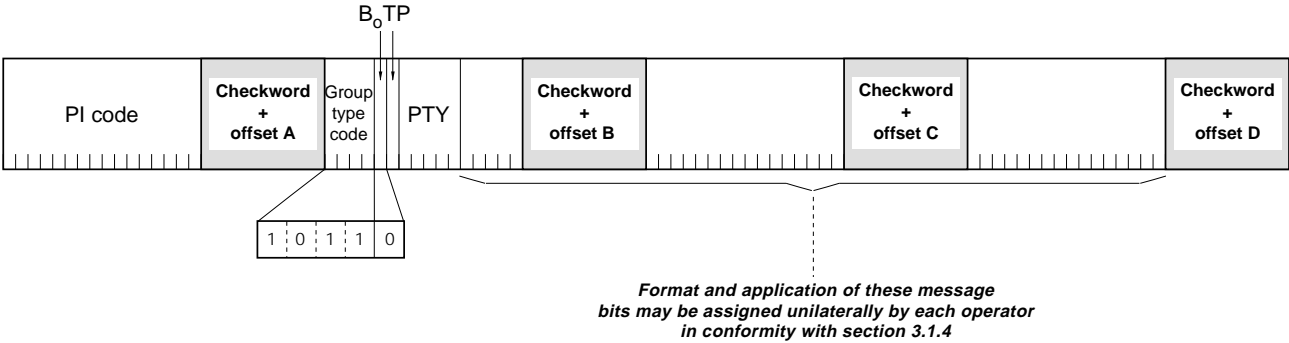

Figure 32: Open data - Type 10B group

3.1.5.15 Type 11 groups: Open Data Application

Figure 33 shows the format of type 11A and 11B groups. These groups are usable for Open data (see 3.1.4).

Type 11A group:



Type 11B group:

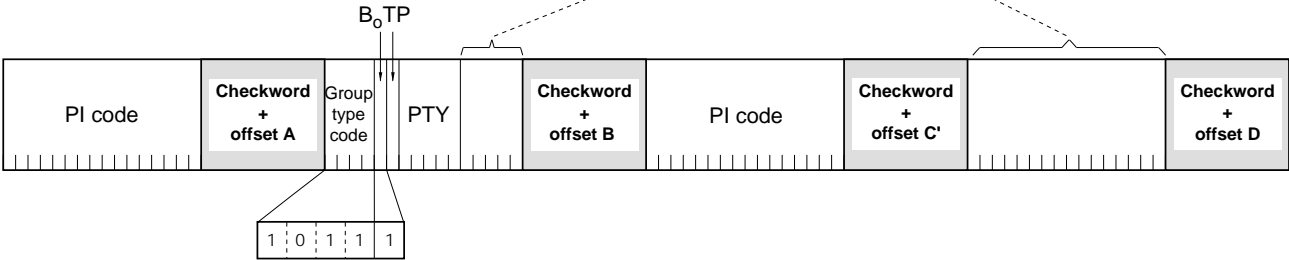
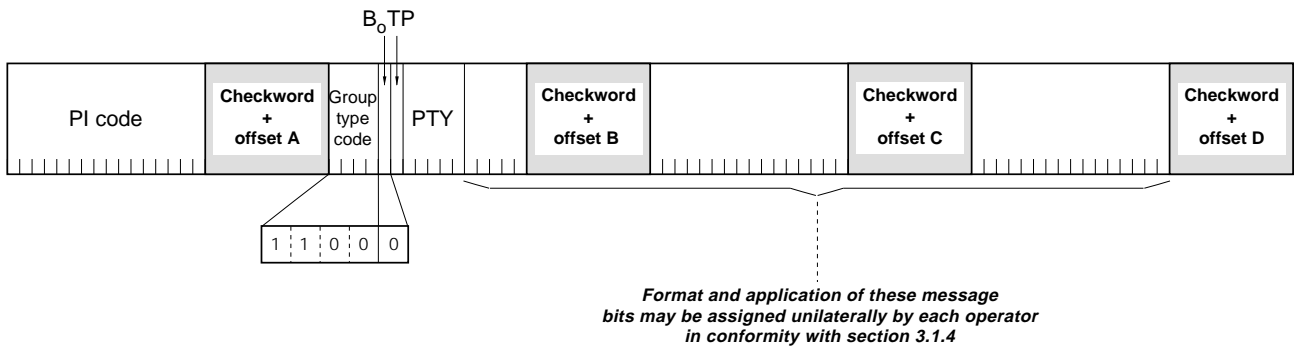

Figure 33: Open data - Type 11A and 11B groups

3.1.5.16 Type 12 groups: Open Data Application

Figure 34 shows the format of type 12A and 12B groups. These groups are usable for Open data (see 3.1.4).

Type 12A group:



Type 12B group:

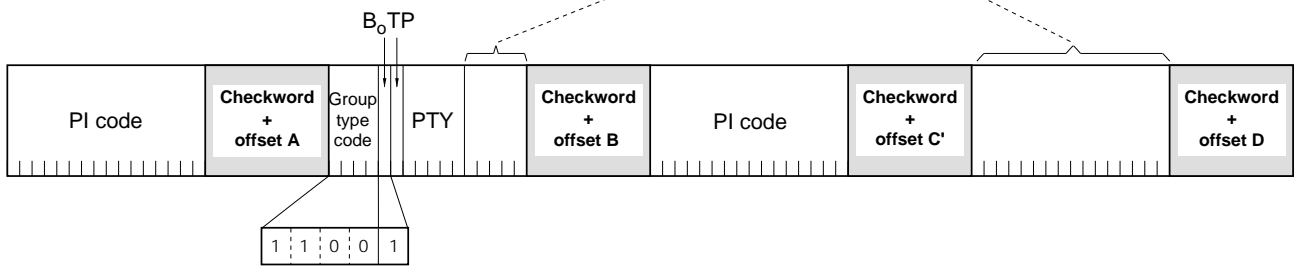

Figure 34: Open data - Type 12A and 12B groups

3.1.5.17 Type 13A groups: Enhanced Radio Paging or ODA

The type 13A group is used to transmit the information relative to the network and the paging traffic. Its primary purpose is to provide an efficient tool for increasing the battery life time of the pager.

Figure 35 shows the format of the type 13A group. These groups are transmitted once or twice at the beginning of every interval (after the type 4A group at the beginning of each minute or after the first type 1A group at the beginning of each interval).

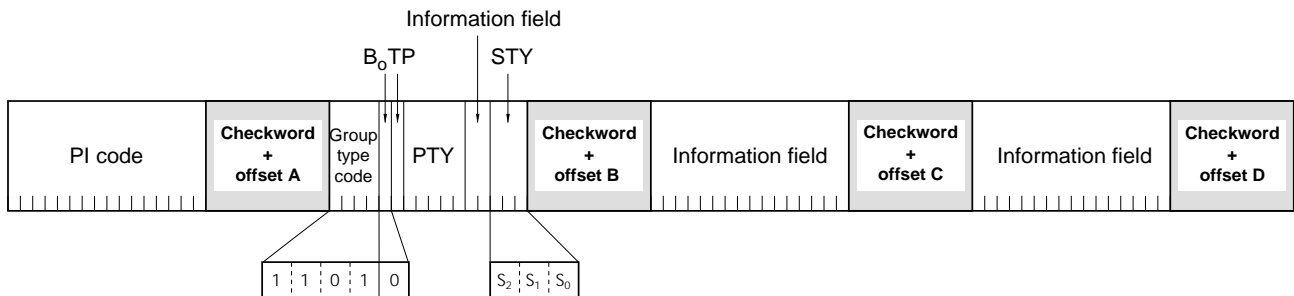

Figure 35: Enhanced Paging information - Type 13A group

The STY code (3 bits) denotes the different type 13A group sub types; there are 8 different sub types:

Table 7: STY codes

STY			Last bits of third block and fourth block of type 13A group
S ₂	S ₁	S ₀	
0	0	0	Address notification bits 24...0, when only 25 bits (one type 13A group) are used
0	0	1	Address notification bits 49...25, when 50 bits (two type13A groups) are used
0	1	0	Address notification bits 24...0, when 50 bits (two type13A groups) are used
0	1	1	Reserved for Value Added Services system information
1	0	0	Reserved for future use
...
1	1	1	Reserved for future use

The specification of the relevant protocol is given in annex M, section M.3.

The type 13A group may be used for ODA when it is not used for Radio Paging, and its group structure is then as shown in 3.1.4.2.

3.1.5.18 Type 13B groups: Open Data Application

Figure 36 shows the format of type 13B groups. These groups are usable for Open data (see 3.1.4).

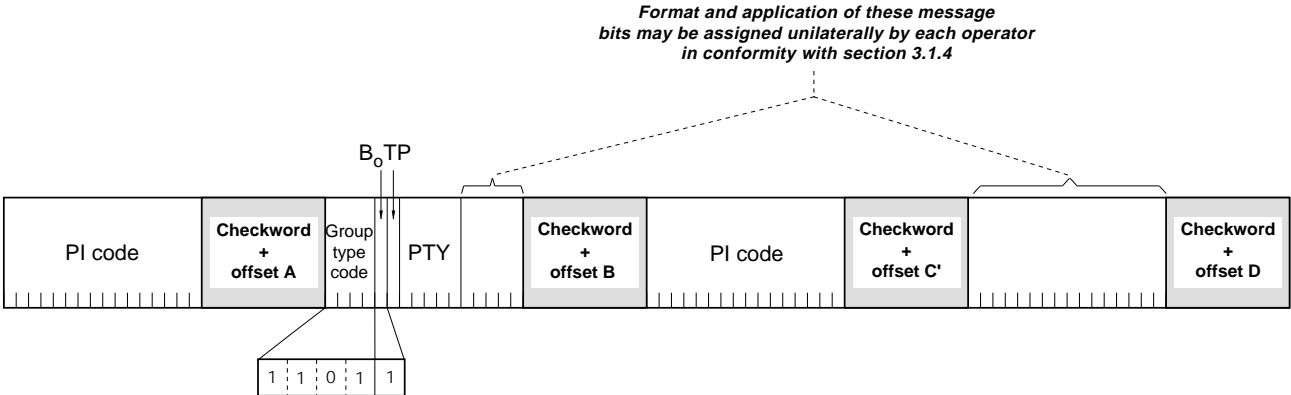

Figure 36: Open data - Type 13B group

3.1.5.19 Type 14 groups: Enhanced Other Networks information

Figures 37 and 38 show the format of type 14A and 14B groups. These groups are transmitted if Enhanced Other Networks information (EON) is implemented. The specification of the relevant protocol is given in 3.2.1.8.

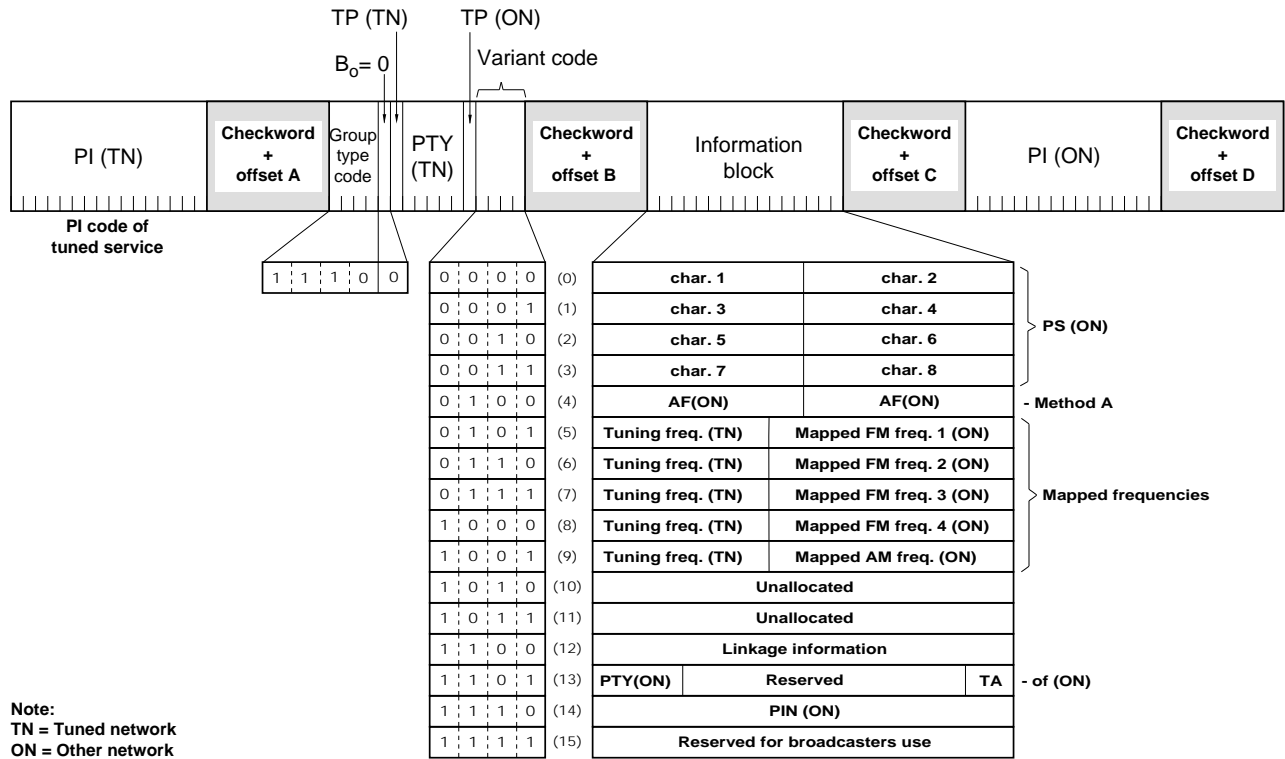

Figure 37: Enhanced Other Networks information - Type 14A groups

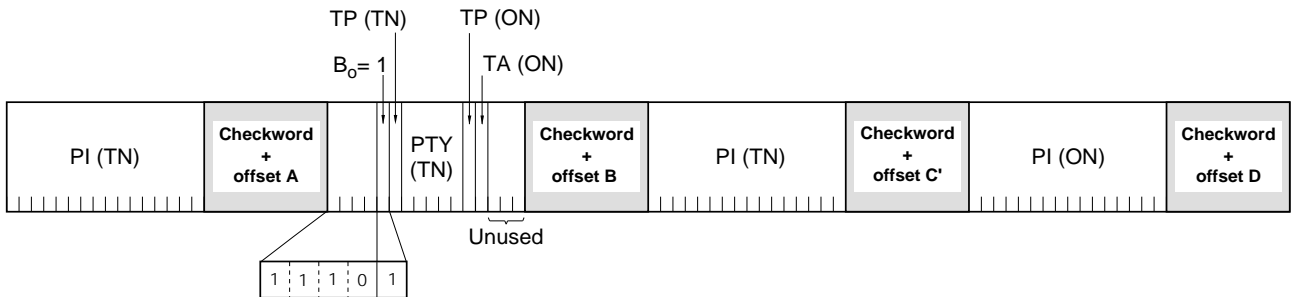

Figure 38: Enhanced Other Networks information - Type 14B groups

3.1.5.20 Type 15A groups

Type 15 groups: Fast basic tuning and switching information

Special note: Group type 15A as defined in Figure 39a is being phased out. Encoder manufacturers should eliminate this group type on new equipment no later than two years after the issuing date of this standard. Receiver manufacturers should eliminate recognition of this group type as soon as possible in all new equipment. After ten years following the issuing date of this standard, group type 15A will be available for reassignment. Reassignment shall be coordinated with the CENELEC RDS standard. The RDS standard currently has no definition for this group.

It is intended that type 15A groups should be inserted where it is desired to speed up acquisition time of the PS name. No alternative frequency information is included in 15A groups, and this group will be used to supplement type 0B groups. If alternate frequencies exist, type 0A will still be required.

It is intended that type 15B groups should be inserted where it is desired to increase the repetition rate of the switching information contained in block 2 of type 0 groups without increasing the repetition rate of the other information contained in these groups. No alternative-frequency information or program-service name is included in 15B groups, and this group will be used to supplement rather than to replace type 0A or 0B groups.

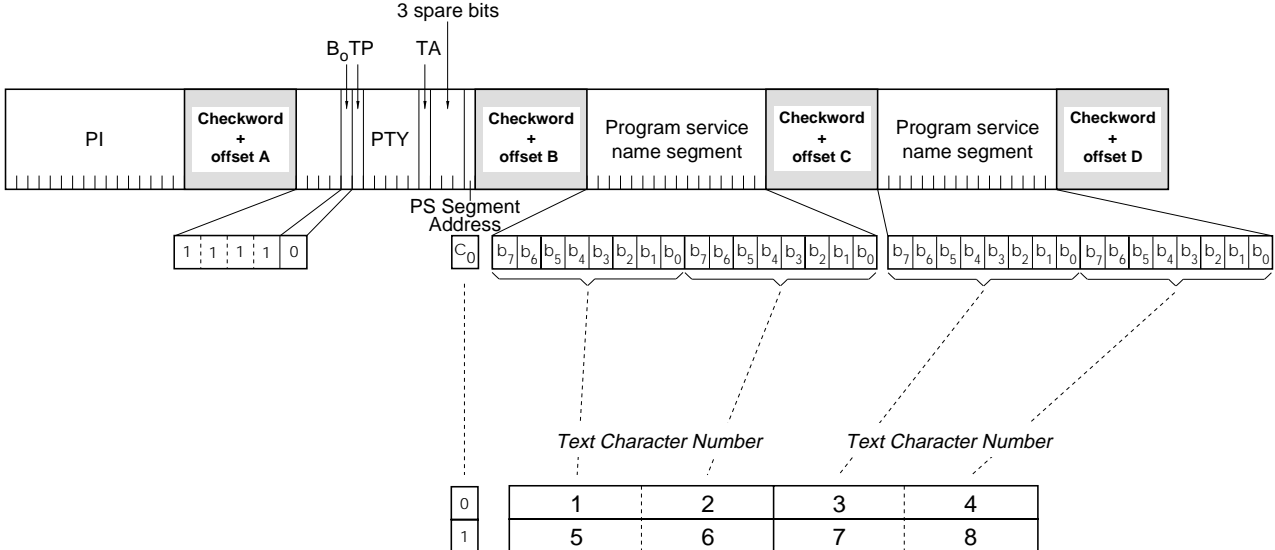

Figure 39a: Fast basic tuning and switching information - Group type 15A

Notes on Type 15A groups

1. Program service name (for display) is transmitted as 8-bit characters as defined in the 8-bit code-tables in annex E. Eight characters (including spaces) are allowed for each network and are transmitted as four character segments in each type 15A group. These segments are located in the displayed name by the code bit C₀ in block 2. The addresses of the characters increase from left to right in the display. The most significant bit (b₈) of each character is transmitted first.
2. For details Program Identification (PI), Program Type (PTY) and Traffic Program (TP) code, see 3.2.1 and annexes D and F.
3. TA = Traffic announcement code (1 bit) (see 3.2.1.3).

3.1.5.21 Type 15B groups: Fast basic tuning and switching information

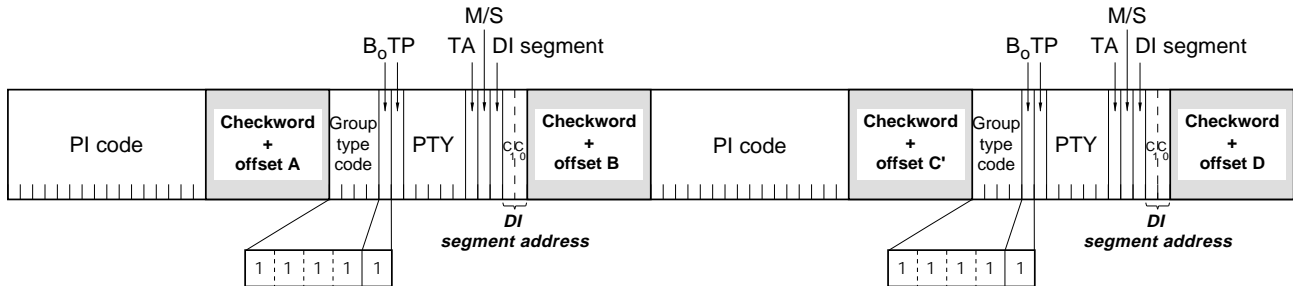

Figure 39b: Fast basic tuning and switching information - Type 15B group

When groups of this type are transmitted, the repetition rate may be chosen to suit the application and the available channel capacity at the time.

Notes on Type 15B groups

1. For details Program Identification (PI), Program Type (PTY) and Traffic Program (TP) code, see 3.2.1 and annexes D and F.
2. TA = Traffic announcement code (1 bit) (see 3.2.1.3).
3. M/S = Music-speech switch code (1 bit) (see 3.2.1.4).
4. DI = Decoder-identification control code (4 bits) (see 3.2.1.5). This code is transmitted as 1 bit in each type 15B group. The DI segment address code (C_1 and C_0) serves to locate these bits in the DI codeword. Thus in a group with $C_1C_0 = "00"$ the DI bit in that group is d_3 . These code bits are transmitted most significant bit (d_3) first.

3.2 Coding of information

A glossary of terms used in RDS applications is given in 4, which also explains the expected responses of a consumer receiver to the various codes.

3.2.1 Coding of information for control

3.2.1.1 Program Identification (PI) codes and Extended country codes (ECC)

The coding model for Program Identification information and Extended country codes is given in annex D.

3.2.1.2 Program Type (PTY) codes

The applications of the 5-bit Program type codes are specified in annex F. PTY codes 30 and 31 are control functions for a consumer receiver (see annex F).

3.2.1.3 Traffic Program (TP) and Traffic Announcement (TA) codes

The coding to be used is as follows:

Table 8

Traffic Program code (TP)	Traffic Announcement code (TA)	Applications
0	0	This program does not carry traffic announcements nor does it refer, via EON, to a program that does.
0	1	This program carries EON information about another program which gives traffic information.
1	0	This program carries traffic announcements but none are being broadcast at present and may also carry EON information about other traffic announcements.
1	1	A traffic announcement is being broadcast on this program at present.

3.2.1.4 Music/speech (M/S) switch code

This is a 1-bit code. A "0" indicates that speech, at present, is being broadcast and a "1" indicates that music, at present, is being broadcast. When the broadcaster is not using this facility the bit value will be set at "1".

3.2.1.5 Decoder identification and Dynamic PTY indicator / DI codes

These 4 bits are used to indicate different operating modes to switch individual decoders on or off and to indicate if PTY codes in the transmission are dynamically switched.

Table 9: Bit d_0 to d_3 meanings

Settings	Meaning
Bit d_0 , set to 0:	Mono
Bit d_0 , set to 1:	Stereo
Bit d_1 , set to 0:	Not Artificial Head
Bit d_1 , set to 1:	Artificial Head
Bit d_2 , set to 0:	Not compressed
Bit d_2 , set to 1:	Compressed ¹
Bit d_3 , set to 0:	Static PTY
Bit d_3 , set to 1:	Indicates that the PTY code on the tuned service, or referenced in EON variant 13, is dynamically switched.

¹) See CCIR Study Program 46A/10 (Dubrovnik, 1986)

3.2.1.6 Coding of alternative frequencies (AFs)

3.2.1.6.1 AF code tables

In the following code tables, each 8-bit binary code represents a carrier frequency, or it represents a special meaning as shown in Tables 10, 11 and 12.

Table 10: VHF code table

Number	Binary code	Carrier frequency
0	0000 0000	Not to be used
1	0000 0001	87.6 MHz
2	0000 0010	87.7 MHz
:	:	:
:	:	:
204	1100 1100	107.9 MHz

Table 11: Special meanings code table

Number	Binary code	Special meaning
0	0000 0000	Not to be used
205	1100 1101	Filler code
206	1100 1110	Not assigned
:	:	:
223	1101 1111	Not assigned
224	1110 0000	No AF exists
225	1110 0001	1 AF follows
:	:	:
249	1111 1001	25 AFs follow
250	1111 1010	An LF/MF frequency follows
251	1111 1011	Not assigned
:	:	:
255	1111 1111	Not assigned

Table 12: LF/MF code table - for ITU regions 1 and 3 (9 kHz spacing)

Number	Binary code	Carrier frequency
LF 1	0000 0001	153 kHz
:	:	:
:	:	:
15	0000 1111	279 kHz
MF 16	0001 0000	531 kHz
:	:	:
:	:	:
:	:	:
:	:	:
135	1000 0111	1602 kHz

3.2.1.6.2 Use of Alternative Frequencies in type 0A groups

To facilitate the automatic tuning process in a receiver, a number of AFs should be transmitted. Ideally the AF list should only comprise frequencies of neighboring transmitters or repeaters. Two methods of transmitting AFs are possible. AF method A is used for lists up to 25 in number and AF method B is used for larger lists. AF method B is also used where it is required to indicate frequencies of generically related services.

3.2.1.6.3 AF method A

Two AF codes are carried in block 3 of each type 0A group. The first byte in the transmitted list (codes 224 - 249) indicates the number of frequencies in that list. This list will also include the frequency of the transmitter originating the list, if it has repeaters.

Examples of AF method A coding:

	Example A		Example B		Example C	
1st 0A:	#5	AF1	#4	AF1	#4	AF1
2nd 0A:	AF2	AF3	AF2	AF3	AF2	AF3
3rd 0A:	AF4	AF5	AF4	Filler	LF/MF follows	AF4

Example A shows: a list of 5 VHF frequencies, where #5 means number of frequencies following is 5 and is represented by code 229.

Example B shows: a list of 4 VHF frequencies, where Filler code is 205.

Example C shows: a list of 3 VHF frequencies and 1 LF/MF frequency, where LF/MF follows code is 250.

3.2.1.6.4 AF method B

Method B AF coding is used where the number of AFs used by a transmitter and its associated repeater stations exceed 25, or where it is required to indicate frequencies which belong to different regions which at times carry different programs.

Each transmitter and associated repeater stations broadcast the same set of different AF lists in sequence. The number of AF lists within a network is in general identical to the number of transmitters and repeater stations in the network so as to provide a unique list for each transmitting station. In this protocol the alternative frequencies for the VHF/FM transmitters are individually addressed by transmitting the tuning frequency paired with one alternative frequency within one block³.

Each list starts with a code giving the total number of frequencies within this list, followed by the tuning frequency for which the list is valid. All remaining pairs² (up to 12) give the tuning frequency together with a valid AF.

- If the number of AFs of a station is larger than 12, the list must be split into two or more lists. These lists are transmitted directly one after the other, and the receiver must combine the lists again.
- If a transmitter frequency is used more than once within a network the respective AF lists are transmitted separately. In order to indicate that these lists with the same tuning frequency belong to different stations, the lists must be separated by AF lists of other stations. The receiver may combine them or evaluate them separately.

³If the frequency referenced is for an LF/MF transmission, it occupies 2 AF codes, the first being code 250. Hence it cannot be referenced to its associated tuning frequency.

For the transmission of the frequency pairs within one block the following convention is used:

- They are generally transmitted in ascending order, e.g.

89.3	99.5	or	99.5	101.8	$F_1 < F_2$
------	------	----	------	-------	-------------

- In special cases they are transmitted in descending order, if they belong to different regions, or carry from time to time different programs, e.g.

99.5	90.6	or	100.7	99.5	$F_1 > F_2$
------	------	----	-------	------	-------------

In both the above examples 99.5 MHz is the tuning frequency.

Examples of a AF method B coding:

F ₁	F ₂	Commentary
# 11	89.3	Total number (11) of frequencies for tuning frequency (89.3)
89.3	99.5	F ₂ > F ₁ hence 99.5 is an AF of tuned frequency 89.3, and is the same program
89.3	101.7	F ₂ > F ₁ hence 101.7 is an AF of tuned frequency 89.3, and is the same program
88.8	89.3	F ₂ > F ₁ hence 88.8 is an AF of tuned frequency 89.3, and is the same program
102.6	89.3	F ₂ < F ₁ hence 102.6 is an AF of a regional variant of tuned frequency 89.3
89.3	89.0	F ₂ < F ₁ hence 89.0 is an AF of a regional variant of tuned frequency 89.3
# 9	99.5	Total number (9) of frequencies for tuning frequency (99.5)
89.3	99.5	F ₂ > F ₁ hence 89.3 is an AF of tuned frequency 99.5, and is the same program
99.5	100.9	F ₂ > F ₁ hence 100.9 is an AF of tuned frequency 99.5, and is the same program
104.8	99.5	F ₂ < F ₁ hence 104.8 is an AF of a regional variant of tuned frequency 99.5
99.5	89.1	F ₂ < F ₁ hence 89.1 is an AF of a regional variant of tuned frequency 99.5

Broadcasters using splitting of a network during certain hours of the day should use AF method B, and not AF method A. The lists should be static, i.e. the AFs included in the list, carrying a different program during certain hours of the day, shall be signaled by transmitting in the descending order. Their PI shall differ in the second element (bits 8 to 11) of the code and may also be static. To identify different regional networks or programs the PI area codes R1 to R12 shall be used (see annex D, D.4).

This convention will permit a receiver to use a regional on/off mode which, when a receiver is in the mode "regional off", will lead to the acceptance of the PI with the differing second element, and thus permit switching to a different regional network. This option can be deactivated by choosing the mode "regional on". Then only AFs having the same second element of the PI (i.e. the same program) will be used. This should also be the case for receivers without regional on/off mode. The switching of the second element of the PI to I, N, or S, respectively, informs a receiver that now even AFs transmitted in descending order carry the same program and the receiver should use this information to allow switching to these AFs.

3.2.1.6.5 Convention for identification of the AF methods used

The AF method used is not signaled explicitly, but can easily be deduced by receivers from the frequent repetition of the tuning frequency in the transmitted AF pairs in the case of AF method B.

3.2.1.6.6 Use of AF Codes in type 14A groups

AF codes in type 14A groups are used to refer to frequencies of other networks. There are two AF methods for transmitting this information.

Variant 4 utilizes AF method A coding to transmit up to 25 frequencies; the coding method is as described above for type 0A groups. The PI code of the other network to which the AF list applies is given in block 4 of the group.

Variant 5 is used for the transmission of "Mapped frequency pairs". This is used to specifically reference a frequency in the tuned network to a corresponding frequency in another network. This is particularly used by a broadcaster that transmits several different services from the same transmitter tower with the same coverage areas.

The first AF code in block 3 refers to the frequency of the tuned network, the second code is the corresponding frequency of the other network identified by the PI code in block 4.

Where it is necessary to map one tuning frequency to more than one VHF/FM frequency for the cross-referenced program service (due to multiple use of the tuning frequency or because the cross-referenced program is receivable at more than one frequency within the service area associated with the tuning frequency), then variants 6, 7 and 8 are used to indicate second, third and fourth mapped frequencies, respectively.

LF/MF mapped frequencies are implicitly signaled by using variant 9. AF Code 250 is not used with the mapped AF method.

3.2.1.7 Program Item Number (PIN) codes

The transmitted Program Item Number code will be the scheduled broadcast start time and day of month as published by the broadcaster. For the coding of this information see 3.1.5.2.

If a type 1 group is transmitted without a valid PIN, the day of the month shall be set to zero. In this case a receiver which evaluates PIN shall ignore the other information in block 4.

3.2.1.8 Coding of Enhanced Other Networks Information (EON)

The enhanced information about other networks consists of a collection of optional RDS features relating to other program services, cross-referenced by means of their PI codes (see 3.2.1.1). Features which may be transmitted using EON for other program services are: AF (see 3.2.1.6.5), PIN (see 3.2.1.7), PS (see 3.2.2), PTY (see 3.2.1.2), TA (see 3.2.1.3), TP (see 3.2.1.3) and Linkage (see 3.2.1.8.3).

The format of the type 14 groups is shown in figures 37 and 38. It has two versions: A and B. The A version is the normal form and shall be used for the background transmission of Enhanced Other Networks information. The maximum cycle time for the transmission of all data relating to all cross-referenced program services shall be less than two minutes. The A version has sixteen variants which may be used in any mixture and order. Attention is drawn to the fact that two distinct options, namely AF method A and the Mapped Frequency Method, exist for the transmission of frequencies of cross-referenced program services (see 3.2.1.8.1). A broadcaster should choose the most appropriate AF method for each cross-referenced program service.

The B version of a type 14 group is used to indicate a change in the status of the TA flag of a cross-referenced program service (see 3.2.1.8.2 for more details).

3.2.1.8.1 Coding of frequencies for cross-referenced program services

Two AF methods exist for the transmission of AF's in the EON feature. Coding is described in 3.2.1.6.5.

A broadcaster may utilize the most appropriate AF method for each cross-referenced program service, but within the reference to any single service these two AF methods must not be mixed.

3.2.1.8.2 Use of the TP and TA features (Type 0, 15B and 14 groups)

For the tuned program service, the code TP=0 in all groups and TA=1 in type 0 and 15B groups indicates that this program broadcasts EON information which cross-references at least to one program service which carries traffic information. RDS receivers which implement the EON feature may use this code to signify that the listener can listen to the tuned program service and nevertheless receive traffic messages from another program service. RDS receivers which do not implement the EON feature must ignore this code. Program services which use the code TP=0, TA=1 must broadcast type 14 B groups (at the appropriate times) relating to at least one program service which carries traffic information, and has the flag TP=1.

The TA flag within variant 13 of a type 14A group is used to indicate that the cross-referenced service is currently carrying a traffic announcement. This indication is intended for information only (e.g. for monitoring by broadcasters) and must not be used to initiate a switch even if traffic announcements are desired by the listener. A switch to the cross-referenced traffic announcement should only be made when a TA=1 flag is detected in a type 14B group.

The type 14B group is used to cause the receiver to switch to a program service which carries a traffic announcement. When a particular program service begins a traffic announcement, all transmitters which cross-reference this service via the EON feature shall broadcast as many as possible of up to eight and at least four appropriate group 14B messages within the shortest practicable period of time (at least four type 14B groups per second).

At the discretion of the broadcaster, a sequence of type 14B groups may be transmitted also when the TA flag is cleared. This option is provided only to assist in the control of transmitters; receivers must use the TA flag in the type 0 or 15B groups of the service which carries the traffic announcements in order to switch back to the tuned program service at the end of the received traffic announcement.

If a transmitter cross-references to more than one traffic program with different PI(ON) via the EON feature, the start time between two references, via type 14B groups, must be two seconds or more.

Note: Some early RDS EON consumer receivers may need up to four correct type 14B groups for reliable functioning. Therefore it is recommended to broadcast as many as possible of up to eight type 14B groups, to ensure the detection of the switching under bad receiving conditions.

The mechanism described above for switching to and from cross-referenced traffic announcements is designed to avoid the delivery of incomplete traffic messages by receivers operating under adverse reception conditions.

3.2.1.8.3 Method for linking RDS program services (Type 1A and 14A groups) - Linkage information

Linkage information provides the means by which several program services, each characterized by its own PI code, may be treated by a receiver as a single service during times a common program is carried.

During such times each program service retains its unique identity, i.e. the program service must keep its designated PI code and its AF (Alternative Frequency) list(s), but may change program related features such as PS, PTY, RT, TP and TA to reflect the common program. With LA=1, a service carrying codes TP=1 or TP=0/TA=1 must not be linked to another service carrying the codes TP=0/TA=0.”

Linkage information is conveyed in the following four data elements:

- 1) LA - Linkage Actuator (1 bit)
- 2) EG - Extended Generic indicator (1 bit)
- 3) ILS - International Linkage Set indicator (1 bit)
- 4) LSN - Linkage Set Number (12 bits)

This information is carried in block 3 of variant 12 of type 14A groups, and informs the receiver to which set of program services any particular service, defined by PI (ON) carried in block 4 of the same group, belongs.

When linkage information regarding the tuned program service is transmitted, the PI code carried in block 4 of the group, PI (ON), will be identical to the PI code carried in block 1.

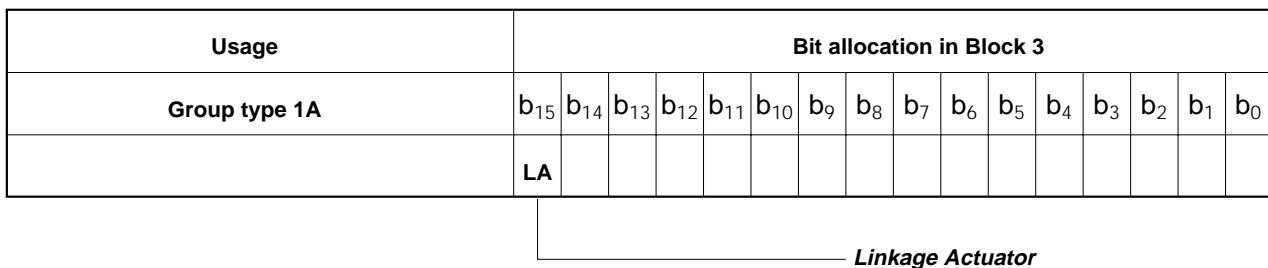

Figure 40: Structure of Block 3 of Type 1A groups

In order to achieve rapid de-linkage at the end of a common program, the Linkage Actuator (LA) for the tuned network is also carried in group type 1A, as bit b₁₅ of block 3 (see 3.1.5.2). This group type should normally be transmitted at least once every 5 seconds, preferably more frequently when a change in status occurs.

The four data elements used to convey linkage information are defined as follows:

LA - Linkage Actuator (see figures 40, 41 and 42)

This bit is set to one to inform the receiver that the program service (indicated by PI(ON) in block 4) is linked to the set of services described by LSN, the Linkage Set Number, at the present moment. If this bit is set to zero, a potential future link is indicated, i.e. the link becomes active at some time in the future. The receiver may then use the linkage data to determine those services for which EON data might usefully be acquired.

EG - Extended Generic indicator (see figures 41 and 42)

This bit is set to one to inform the receiver that the program service, defined in block 4 of a type 14A group is a member of an extended generic set. Such a set comprises program services which are related (e.g. by common ownership, or a similar format) - but which do not necessarily carry the same audio.

An extended generic set is characterized by PI codes of the form WXYZ, where W is the common country code, X is the area code (and must lie in the range R1 to R12), Y is common to all such related services, and Z may assume any value.

ILS - International Linkage Set indicator (see figures 41 and 42)

In case of an international link, the indicator ILS (bit b₁₂ of block 3 in variant 12 of group type 14A) will be set to one.

LSN - Linkage Set Number (see figures 41 and 42)

This 12 bit number is carried in block 3 of variant 12 of type 14A groups. The LSN, when non-zero, is common to those program services which may be linked together as a set according to the status of the Linkage Actuator, either active (LA=1) or potential (LA=0, i.e. the link becomes active at some time in the future).

The special case of LSN=0 is used as a default condition, and two or more services sharing LSN=0 are not linked.

The LSN may be used to link together two or more programs either nationally or internationally.

- National link (ILS=0)

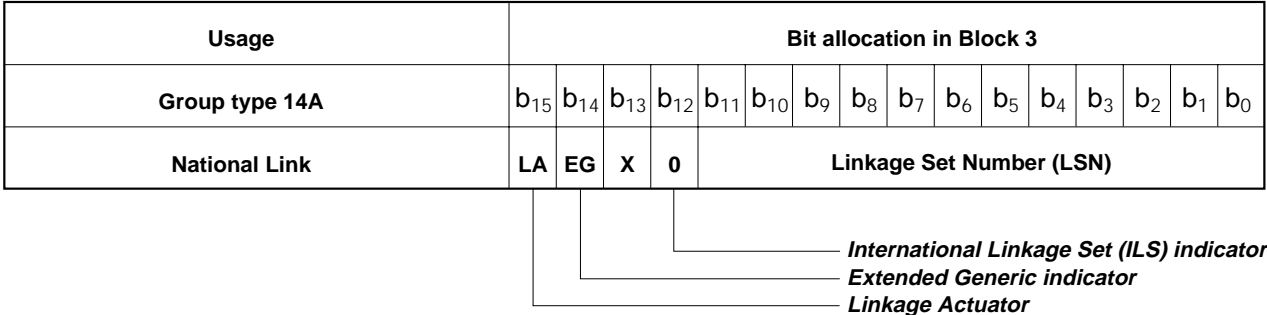

Figure 41: Structure of variant 12 of block 3 of type 14A groups (linkage information) - National link

If two or more program services with the same country code carry the same non-zero LSN and their respective LA bits are set to one, then the receiver may assume that the program services are carrying the same audio.

- International link ($ILS=1$)

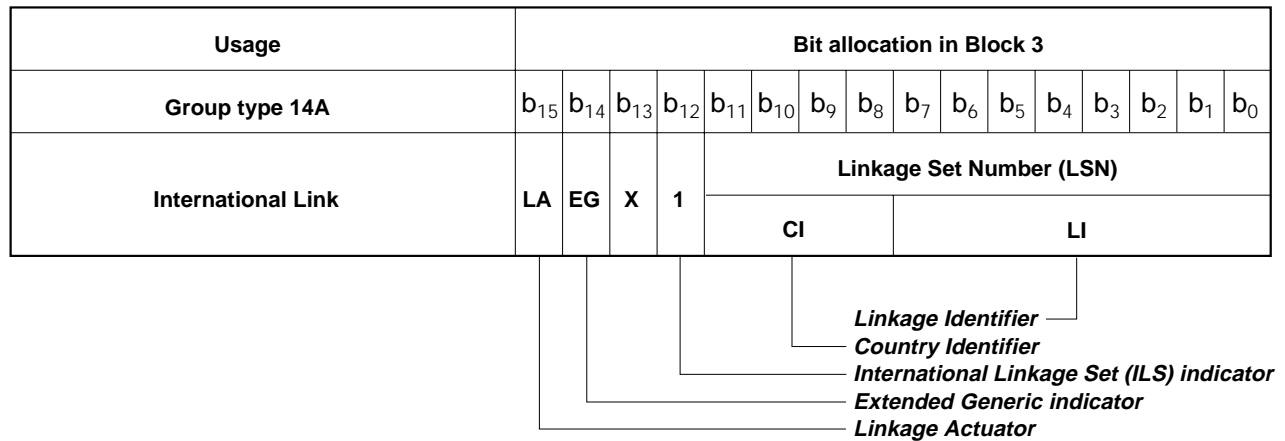

Figure 42: Structure of variant 12 of block 3 of type 14A groups (linkage information) - International link

In this case of an international link, the LSN is deemed to comprise two elements:

CI-Country Identifier: Bits b₁₁ to b₈ of block 3 shall be the country code of one of the two (or more) participating countries. For example, if Switzerland and Italy share a program, they shall choose either HEX 4 or 5 for CI, and then agree on bits b₇ to b₀ for a unique **Linkage Identifier (LI)**.

LI-Linkage Identifier: Bits b₇ to b₀ are used to relate program services internationally, and shall be agreed between the countries concerned. Such services share the same CI and LI.

When two or more program services with the same or different country codes carry the same non-zero Linkage Set Number and their respective ILS and LA bits are set to one, then the receiver may assume that the program services are carrying the same audio.

In figures 41 and 42 the bit indicated by "X" is not assigned to the linkage application and may be assumed to be in either state.

Conventions for application regarding the use of the LSN:

A link (potential or active) between any two or more program services is considered to be valid only when the program services are all linked with a common Linkage Set Number (LSN). No more than one Linkage Set Number will apply to any given program service at the same time. Interleaving of different Linkage Set Numbers relating to the same program service, e.g. an active link and a future potential link, is not permitted. An active link between m program services out of n potentially linked services ($m < n$) is considered to be valid only when the Linkage Actuators (LA) in the linkage words concerning those m services are set to one.

3.2.2 Coding and use of information for display

Code tables for the displayed 8-bit text characters relating to the Program Service name, Radiotext, Program Type Name and alphanumeric Radio Paging are given in annex E.

The Program Service name comprises eight characters. It is the primary aid to listeners in program service identification and selection. The Program Service name is to be used only to identify the station or station program. This text may be changed as required by the station, but shall not be scrolled or flashed or altered in a manner that would be disturbing or distracting to the viewer (i.e. not more frequently than once per minute).

Radiotext messages potentially can be distracting to a car driver. For safety, manufacturers of car radios must ensure that display of Radiotext should only be available when specially enabled by the car user. The default mode should be set to off.

3.2.3 Coding of Clock Time and date

The transmitted clock-time and date shall be accurate; otherwise the transmitted CT codes shall all be set to zero.

In order to avoid ambiguity when radio-data broadcasts from various sources are processed at one point (e.g. reception from multiple time zones), and to allow calculations of time intervals to be made independent of time zones and summer-time discontinuities, the broadcast time and date codes will use Coordinated Universal Time (UTC) and Modified Julian Day (MJD). A coded local time-difference, expressed in multiples of half-hours is appended to the time and date codes.

Conversion between the Modified Julian Day date and UTC time codes and the various calendar systems (e.g. year, month, day, or year, week number, day of week) can be accomplished quite simply by processing in the receiver decoder (see annex G).

3.2.4 Coding of information for Transparent Data Channels⁴

The coding of this information may be decided unilaterally by the operator, to suit the application. Consumer RDS receivers may provide an output of it (e.g. as a serial data stream) for an external device (e.g. a home computer).

⁴MMBS coding may be used as an alternative to RDS coding. MBS messages are variable length ranging from 3 to 8 blocks. The MBS block is structured identically to the RDS block, except that the offset word E consist of all zeros. See annex P, table P.2 - MMBS message. The MMBS group consisting of MBS blocks is modulo-4 length, i.e. 0,4,8,-blocks. For a complete description of RDS/MMBS multiplex sequence, see annex P.

3.2.5 Coding of information for In House applications⁵

The coding of this information may be decided unilaterally by the broadcaster to suit the application. Consumer RDS receivers should entirely ignore this information.

3.2.6 Coding of Radio Paging (RP)⁶

Radio paging is described in detail in annex M.

3.2.6.1. Introduction

The Radio paging system explained here is also described in Specification No. 1301/A694 3798 (issued by Swedish Telecom Radio) [9].

The two Radio paging protocols in this standard are:

- Radio paging as described in annex M, section M.2 and,
- Enhanced Paging Protocol (EPP) as described in annex M, section M.3.

As the Enhanced Paging Protocol is an improvement of Radio paging, upwards compatibility is assumed.

Radio paging offers the following features:

- Radio paging:

Support for a wide range of message types, including international paging calls,
It is possible to use simultaneously more than one program service (up to four) to carry the paging information. This allows flexibility to meet peak demands for the transmission of paging codes,
Battery-saving techniques are employed.

- Enhanced Paging Protocol:

Possibility to support multi operator and/or multi area paging services,
Increased battery life time,
Implementation of an international Radio paging service,
Pager's compatibility with the RBDS standard,
Extension of address range capability for a flexible management of a large number of pagers,
Increased reliability of the system,
Message labeling,
Extension of the range of message types.

⁵ Id.

⁶ Id.

3.2.6.2 Identification of paging networks

3.2.6.2.1 *No paging on the network*

As some fields of type 1A groups are used for paging, either basic or enhanced, and to avoid conflicts with other applications, the following rules must to be respected by broadcasters/operators, when type 1A groups are transmitted:

- The 5 bits of the block 2 relative to the paging are set to zero.
- The 4 bits of the block 3 of type 1A group, variant 0, reserved for paging are set to zero.
- When no valid PIN is broadcast, all the five most significant bits of block 4 (day) shall be set to zero.
- Type 1A group, variant 2, shall not be transmitted.

3.2.6.2.2. *Paging on the network*

- Type 4A group⁷, Clock time and date (CT), is transmitted at the start of every minute.
- Type 1A groups are transmitted at least once per second. All the fields of type 1A groups allow the identification of the paging protocol level:

Radio Paging,
Enhanced Paging Protocol, or
Mixed.

The description of these protocols is detailed in the annex M.

- Type 7A group is used to convey the paging information.
- Type 13A group, which is used to transmit the information relative to the network and the paging traffic, is optional and used only in case of enhanced or mixed paging.

⁷The transmitted CT (see 3.1.5.6 and 3.2.3) must be accurate, otherwise the CT codes must all be set to zero.

3.2.7 Coding of Emergency warning systems (EWS) ⁸

The information is carried by type 9A groups (see 3.1.5.13) and this service may be independent of the warning and alarm codes (PTY = 30 and PTY = 31).

The type 1A group identification is also required to operate this service, as follows:

Variant 7 in block 3 of the type 1A group (see figure 43) is used to identify the transmission that carries emergency messages to enable specific receivers, evaluating these messages to automatically tune to the corresponding channel. The repetition rate depends on the exact national implementation, but should normally not exceed one type 1A group every two seconds.

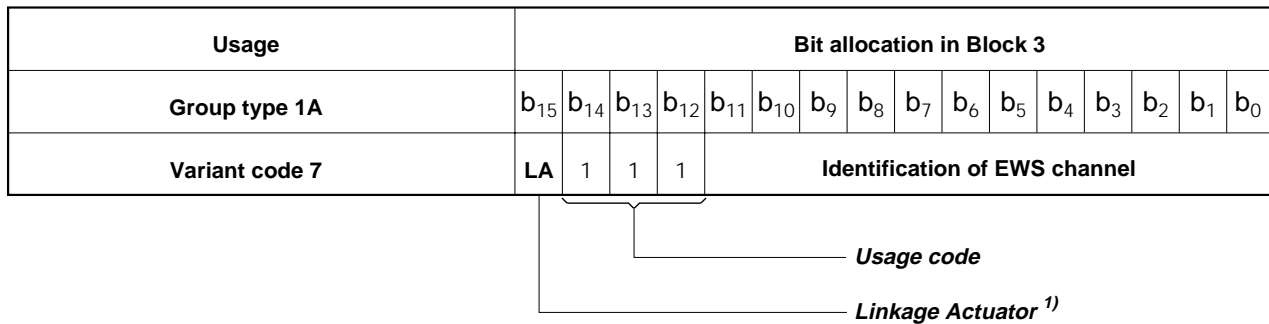

¹⁾ The Linkage Actuator is defined in the Method for Linking RDS Program Services (see 3.2.1.8.3)

Figure 43: Structure of Variant 7 of Block 3 of type 1A groups
 (Identification of a program carrying EWS information)

⁸ See, supra note 3 (MMBS coding as an alternative to RDS coding)

4 Description of features

4.1 AF - Alternative Frequencies list

The list(s) of alternative frequencies give information on the various transmitters broadcasting the same program in the same or adjacent reception areas, and enable receivers equipped with a memory to store the list(s), to reduce the time for switching to another transmitter. This facility is particularly useful in the case of car and portable radios. Coding of alternative frequencies is explained in 3.2.1.6.2.

4.2 CT - Clock Time and date

Time and date codes should use Coordinated Universal Time (UTC) and Modified Julian Day (MJD). Details of using these codes, which are intended to update a free running clock in a receiver are given in 3.2.3 and annex G. If MJD = 0 the receiver should not be updated. The listener, however, will not use this information directly and the conversion to local time and date will be made in the receiver's circuitry. CT is used as time stamp by various RDS applications and thus it must be accurate.

4.3 DI - Decoder Identification and dynamic PTY indicator

These bits indicate which possible operating modes are appropriate for use with the broadcast audio and to indicate if PTY codes are switched dynamically.

4.4 ECC - Extended Country Code

RDS uses its own country codes (see annexes D and N). The first most significant bits of the PI code carry the RDS country code. The four bit coding structure only permits the definition of 15 different codes, 1 to F (hex). Since there are much more countries to be identified, some countries have to share the same code which does not permit unique identification. Hence there is the need to use the Extended Country Code which is transmitted in Variant 0 of Block 3 in type 1A groups and together with the country identification in bits b_{15} to b_{12} of the PI code render a unique combination. The ECC consists of eight bits.

4.5 EON - Enhanced Other Networks information

This feature can be used to update the information stored in a receiver about program services other than the one received. Alternative frequencies, the PS name, Traffic Program and Traffic Announcement identification as well as Program Type and Program Item Number information can be transmitted for each other service. The relation to the corresponding program is established by means of the relevant Program Identification (see 3.2.1.8). Linkage information (see 3.2.1.8.3), consisting of four data elements, provides the means by which several program services may be treated by the receiver as a single service during times a common program is carried. Linkage information also provides a mechanism to signal an extended set of related services.

4.6 EWS - Emergency Warning System

The EWS feature is intended to provide for the coding of warning messages. These messages will be broadcast only in cases of emergency and will only be evaluated by special receivers (see 3.2.7).

4.7 IH - In House application

This refers to data to be decoded only by the operator. Some examples noted are identification of transmission origin, remote switching of networks and paging of staff. The applications of coding may be decided by each operator itself.

4.8 M/S - Music Speech switch

This is a two-state signal to provide information on whether music or speech is being broadcast. The signal would permit receivers to be equipped with two separate volume controls, one for music and one for speech, so that the listener could adjust the balance between them to suit his individual listening habits.

4.9 ODA - Open Data Applications

The Open Data Applications feature (see 3.1.4) allows data applications, not previously specified in EN 50067, to be conveyed in a number of allocated groups in an RDS transmission. The groups allocated are indicated by the use of type 3A group which is used to identify to a receiver the data application in use in accordance with the registration details in the EBU/RDS Forum - Open Data Applications Directory, and the NRSC Open Data Applications Directory (see annex L).

4.10 PI - Program Identification

This information consists of a code enabling the receiver to distinguish between countries, areas in which the same program is transmitted, and the identification of the program itself. The code is not intended for direct display and is assigned to each individual radio program, to enable it to be distinguished from all other programs. One important application of this information would be to enable the receiver to search automatically for an alternative frequency in case of bad reception of the program to which the receiver is tuned; the criteria for the change-over to the new frequency would be the presence of a better signal having the same Program Identification code.

4.11 PIN - Program Item Number

The code should enable receivers and recorders designed to make use of this feature to respond to the particular program item(s) that the user has preselected. Use is made of the scheduled program time, to which is added the day of the month in order to avoid ambiguity (see 3.2.1.7).

4.12 PS - Program Service name

This is the label of the program service consisting of not more than eight alphanumeric characters coded in accordance with annex E, which is displayed by RDS receivers in order to inform the listener what program service is being broadcast by the station to which the receiver is tuned (see 3.1.5.1). An example for a name is "Radio 21". The Program Service name is not intended to be used for automatic search tuning and must not be used for giving sequential information.

4.13 PTY - Program TYpe

This is an identification number to be transmitted with each program item and which is intended to specify the current Program Type within 31 possibilities (see annex F). This code could be used for search tuning. The code will, moreover, enable suitable receivers and recorders to be pre-set to respond only to program items of the desired type. The last number, i.e. 31, is reserved for an alarm identification which is intended to switch on the audio signal when a receiver is operated in a waiting reception mode.

4.14 PTYN - Program TYpe Name

The PTYN feature is used to further describe current PTY. PTYN permits the display of a more specific PTY description that the broadcaster can freely decide (e.g. PTY=4: Sport and PTYN: Football). The PTYN is not intended to change the default eight characters of PTY which will be used during search or wait modes, but only to show in detail the program type once tuned to a program. If the broadcaster is satisfied with a default PTY name, it is not necessary to use additional data capacity for PTYN. The Program Type Name is not intended to be used for automatic PTY selection and must not be used for giving sequential information.

4.15 RP - Radio Paging

The RP feature is intended to provide radio paging using the existing VHF/FM broadcasts as a transport mechanism, thereby avoiding the need for a dedicated network of transmitters. Subscribers to a paging service will require a special pocket paging receiver in which the subscriber address code is stored.

The detailed coding protocols are given in annex M.

4.16 RT - RadioText

This refers to text transmissions coded in accordance with annex E, primarily addressed to consumer home receivers, which would be equipped with suitable display facilities (see 3.2.2).

4.17 TA - Traffic announcement identification

This is an on/off switching signal to indicate when a traffic announcement is on air. The signal could be used in receivers to:

- a) switch automatically from any audio mode to the traffic announcement;
- b) switch on the traffic announcement automatically when the receiver is in a waiting reception mode and the audio signal is muted;
- c) switch from a program to another one carrying a traffic announcement, according to those possibilities which are given in 3.2.1.3 or 3.2.1.8.2.

After the end of the traffic announcement the initial operating mode will be restored

4.18 TDC - Transparent Data Channels

The transparent data channels consist of 32 channels which may be used to send any type of data.

4.19 TMC - Traffic Message Channel

This feature is intended to be used for the coded transmission of traffic information. The coding is separately defined by a standard issued by CEN [prENV 12313] (see 3.1.5.12).

4.20 TP - Traffic Program identification

This is a flag to indicate that the tuned program carries traffic announcements. The TP flag must only be set on programs which dynamically switch on the TA identification during traffic announcements. The signal shall be taken into account during automatic search tuning.

4.21 Mobile Search (MBS) (Mobilsökning)

The Swedish Telecommunications Administration (Televerket) Specification for the Swedish Public Radio Paging System.

4.22 Modified MBS (MMBS)

MBS modified for time multiplexing with RDS.

5 Marking

Equipment using RDS features should be marked with one of the symbols given in annex K.

Europe - Copyright of these symbols is owned jointly by the European Broadcasting Union and the British Broadcasting Corporation. These organizations freely grant permission to use these symbols to all manufacturers of RDS equipment to be used on equipment conforming to this specification, in whole or in part, and upon literature and packaging relating to such products.

U.S.A. - Trademark of these symbols is owned by the National Association of Broadcasters on behalf on the National Radio Systems Committee. Manufacturers wishing to use these symbols must obtain certification that the products or equipment conform to this specification. Contact:

RDS Certification Program
c/o Consumer Electronic Manufacturers Association
2500 Wilson Boulevard
Arlington, VA. 22201

Phone: (703) 907-7500

6 AM RDS

This section is reserved for the inclusion of dynamic data transmission methods which will allow AM broadcast stations to transmit RDS data and dynamically participate in RDS features. The NRSC will study various AM RDS data transmission schemes, from time to time, as they are presented to the NRSC. The NRSC reserves the right to include material within this Section relevant to AM data systems that can co-exist with all aspects of this Standard.

7 In-Receiver Database System (I-RDS)

The material in Section 7 and Annex R is proprietary and requires the acquisition of a license from its owner for its implementation in hardware, firmware and/or software.

The in-receiver database system (I-RDS) permits the automatic identification of any station and offers format scanning in both AM and FM. (See Annex R for implementation details.)

7.1 Architecture

I-RDS consists of a database of information relating to radio stations stored in read-only memory (ROM) and of a database of contingent updating information stored in a random-access memory (RAM). The ROM and the RAM are accessed by the receiver's central processor unit (CPU).

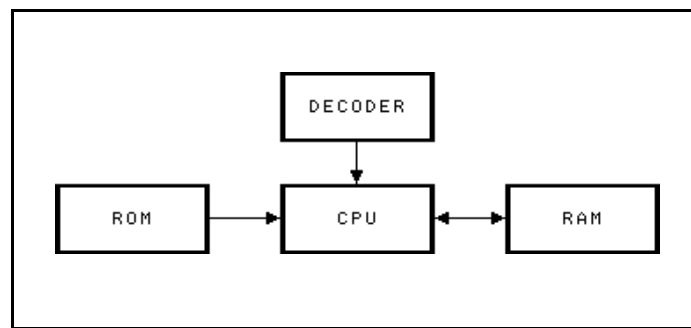

Figure 44 - Hardware architecture

The ROM database is burned-in during manufacture. The update data is collected by the RDS decoder from the open data application identified by AID code C563 and stored in the RAM.

The ROM database describes the AM and FM radio stations which are broadcasting in the continent in terms of:

- Call sign
- Frequency and band
- Format (usual PTY)
- RDS update capability
- City and state of license

In addition the ROM contains a description of a large number of cities in terms of:

- City and country (ISO2) or state (North America) abbreviation
- Latitude and longitude

The RAM database consists of updating data and the location (address) at which the ROM data it supersedes is located.

7.2 Automatic Identification and Updates

- While tuned to an RDS station, the receiver uses the RDS data available in the subcarrier.
- If the RDS station is also an update giving station, any relevant update can be collected from the open data application identified by AID code C563 and stored in the RAM.
- If tuned to any other (non-RDS) station -- whether in AM or FM, the receiver uses the ROM database, checking the RAM for updated information, if any.

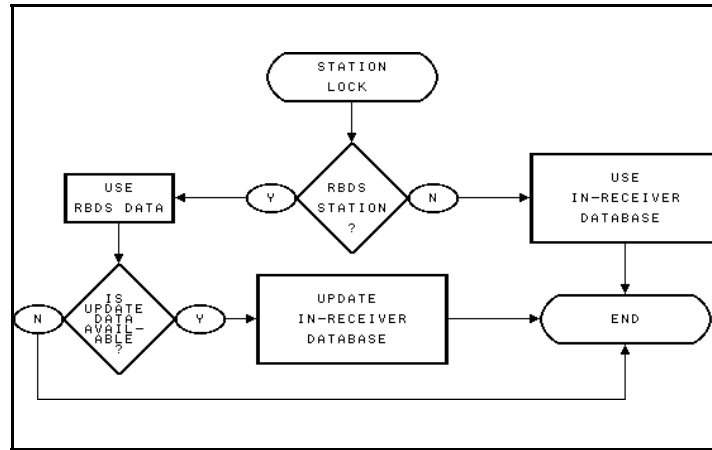

Figure 45 - RDS vs. I-RDS decision

7.3 PTY/Format Scanning

Although PTY (program type) and format mean essentially the same thing, they do adopt different meanings within RDS and I-RDS:

Within RDS, the PTY means the type of program which is currently being broadcast; whereas within I-RDS, the format of a station means the type of program which is generally broadcast by that station. As the RDS data is very dynamic, when the user initiates a PTY search, the RDS system must first scan the participating stations in the FM band to determine if the desired program type is being currently broadcast; whereas I-RDS can immediately find in the database if the desired format is available -- in either band.

Since there are advantages in both approaches, it is suggested that a switch be provided for the user to choose the preferred method.

7.4 Automatic/Manual Update

As mentioned above, part of the ROM data describing a station indicates whether that station is an update-giving station (Updating Station) or not. I-RDS is thus capable to tune itself to an Updating Station either automatically or on demand.

Several modes of update seeking can be offered in the receiver:

- Automatic update 1: When the receiver is turned off (preferred) and before going to sleep, it can immediately tune itself to the local Updating Station and load whatever update is relevant.
- Automatic update 2: When the receiver is turned on and before resuming normal operation.
- Automatic update 3: If a in-receiver clock is available, the receiver can wake up at a predetermined time (e.g., at 4:00 AM) and seek any relevant update.
- Automatic update 4: Whenever the receiver travels into new territory (see below), it can seek the Updating Station serving that new area and load any relevant update.
- Manual update: Whenever an Update key is actuated by the user.

7.5 Geographical Reference

For geographical reference, a continent is divided into a matrix of rectangles of $\frac{1}{2}$ degree latitude by $\frac{1}{2}$ degree longitude resolution. Each rectangle (Grid) is coded by a unique number which identifies both station location and the location of the receiver at any given time.

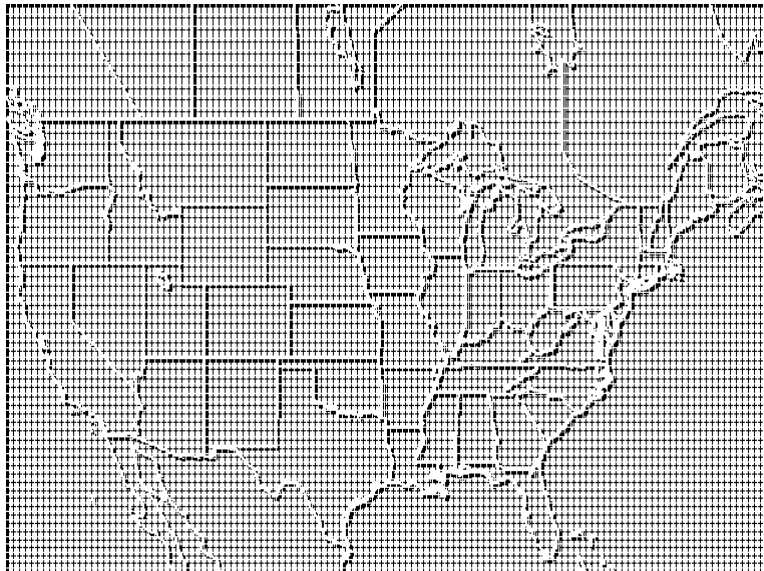

Figure 46 - Grid system

When searching the ROM for information on local radio stations, the processor typically first searches the Grid defined by the location of the receiver (e.g., Baltimore in Figure 47). Then it searches in the eight Grids directly contiguous to that location.

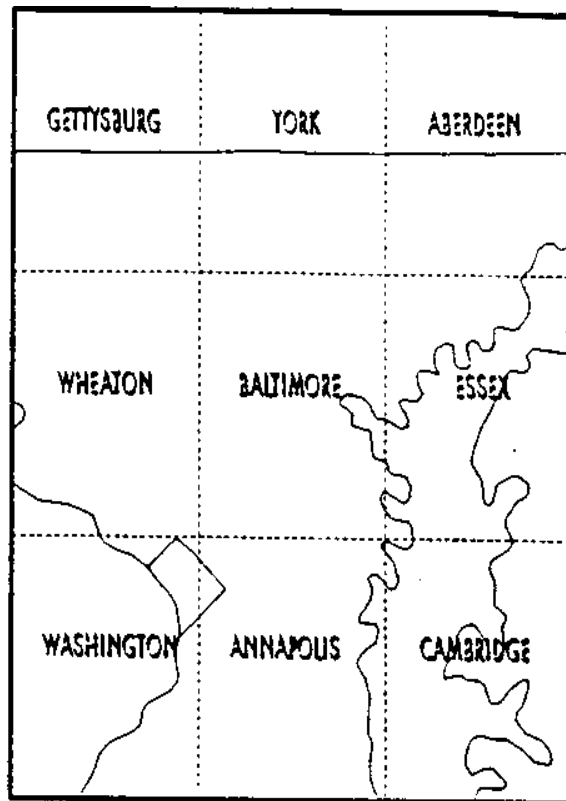

Figure 47 Nine-grid pattern example

Upon installation, the user must be able to pick the name of the city defining his or her location. This is achieved by scrolling through a displayed alphabetical listing of states, and then, likewise, through a list of cities within the state of interest. Each city is referenced in the ROM by its unique Grid number. This provides I-RDS with the center location of the nine-grid system as described above. Then, if the receiver travels outside of its original Grid, the user must be able to press one (or two) of four compass keys (i.e., N/E/S/W) to indicate the general direction of travel. In the absence of any RDS station in the area and given the grid resolution of $\frac{1}{2}$ degrees latitude and longitude, this direction entry may be needed at most every 30 miles or so.

A well designed system should provide feedback to the user upon the actuation of a compass key. This is achieved by displaying the largest city in the new grid as described in Figure R.9 and section R.12.5.

Note: Alternatively, it is possible to license an automatic positioning system which determines the receiver's location based on the active frequencies at that location. This system can be used both to automatically set the location of the receiver, upon installation, and to automatically track its movement while driving.

7.6 - I-RDS ROM Structure

A 2 megabit (256 kilobyte) ROM is required to store the in-receiver database.

As seen in the following figure, the database is composed of the following files:

- Header File
- Format File
- Map File
- State/Country File
- City File
- AM Band File
- FM Band File

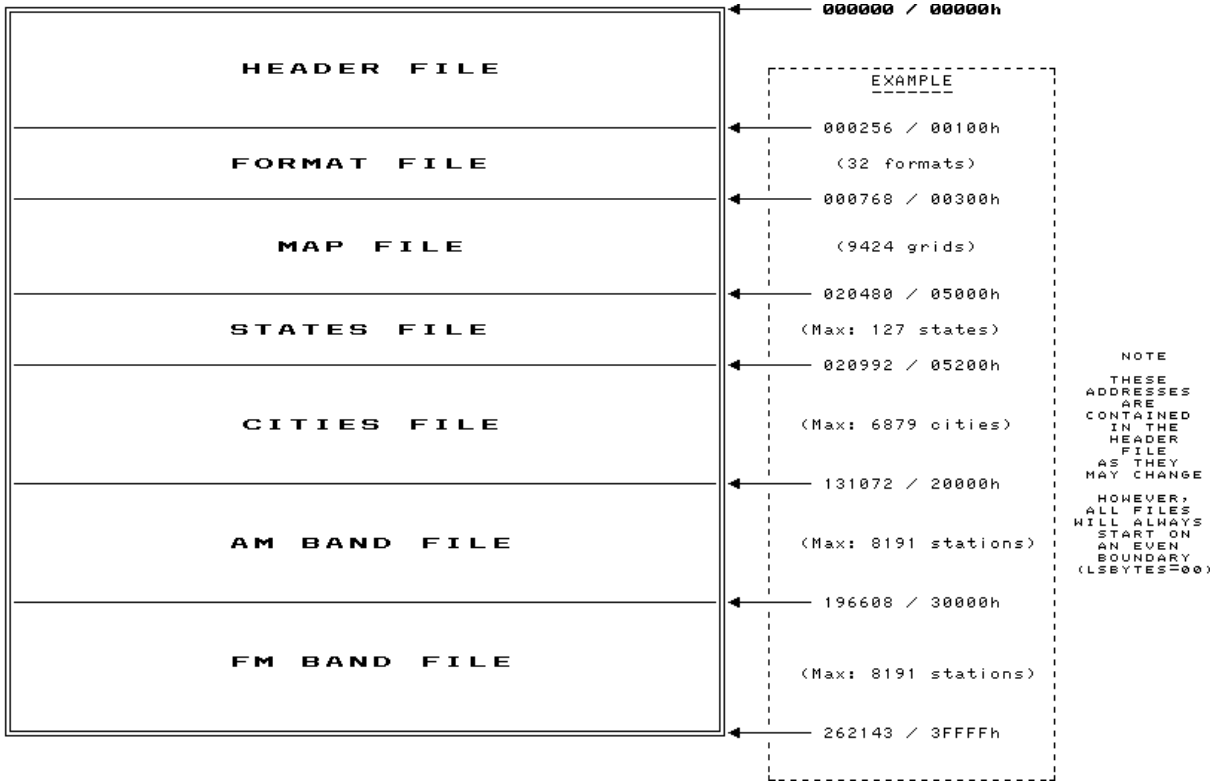

Figure 48 - 256 kilobyte ROM structure

The addresses shown in Figure 48 are contained in the Header File as they may change. However, all files will always start on an even boundary (L.S. Bytes = 00 or modulo 100hex).

All I-RDS files are discussed in detail in Annex R.

7.7 Update Transmissions

Updates can be stored manually or received automatically via the open data application identified by AID code C563. See section 3.1.4 for a description of the Open Data Application / Applications Identification. Figure 49 illustrates the five steps required before loading an update:

- Step 1: Lock onto an FM station
- Step 2: It must be an RDS station
- Step 3: Wait for a Group 3A - AID code C563
- Step 4: The ROM class number must match that of the receiver's
- Step 5: The update serial number must be different from any stored during previous updates.

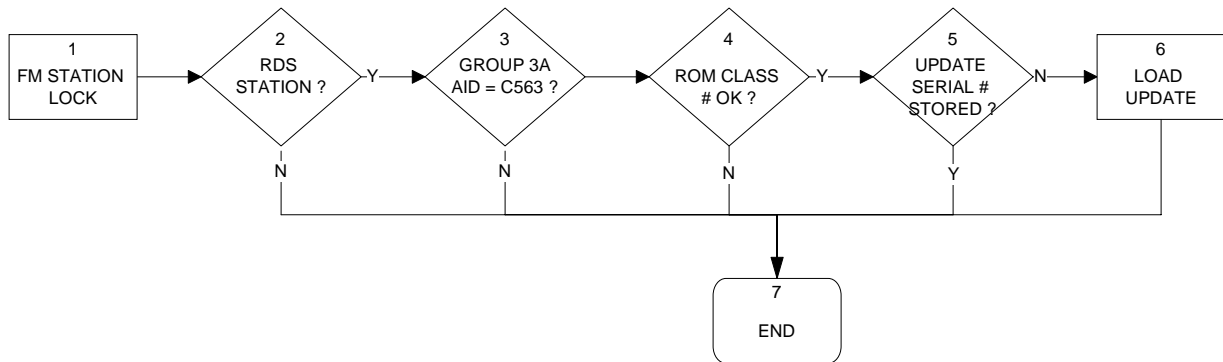

Figure 49 - Relevant Update Search

7.7.1 Transmission scope

Each update transmitted contains updates concerning the stations in the 1 to 81 grids surrounding the Updating Station (depending on the density of Updating Stations).

There are two kinds of updates:

- Total updates: These updates convey all changes that occurred in the region since the manufacture of the ROM.
- Partial updates: These updates convey all changes that occurred in the region since the previous partial update.

7.7.2 Transmission structure

The I-RDS data updates are obtained via the RDS open data application feature. I-RDS updates are signaled via an AID code equal to C563. This application operates in Mode 1.1, utilizing A type groups for update data transmission. Critical update information is also contained within Group 3A as outlined below.

7.7.3 Group 3A data structure

The following I-RDS specific information is contained within group 3A:

1. The I-RDS application identification code(AID), C563
2. The ROM class number to which the update is destined (5 bits)
3. The serial number of the update transmission (10 bits)
4. The scope flag of the update: partial or total (1 bit)

Figure 50 depicts the structure of I-RDS open data application; group type 3A.

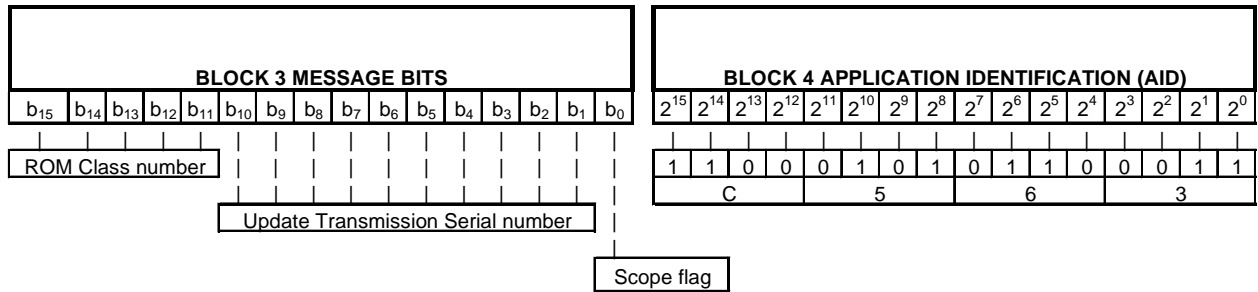

Figure 50 - I-RDS Open Data Application, group 3A

7.7.3.1 - ROM class number: This 5 bit number identifies the class of the ROMs which are targeted by the update. This number ranges from 0 to 31.

7.7.3.2 - Update serial number: This 10 bit code contains a serial number which uniquely identifies the transmission. This number ranges from 0 to 1023.

7.7.3.3 - Scope flag: This single bit flag determines whether the update is partial or total where: 0 = Partial, and 1 = Total.

Depending on the frequency of update changes and the data load required by all of the RDS applications, the broadcaster may choose to send a mixture of partial (shorter) and total (longer) updates.

Shorter partial updates are *additive* updates. I-RDS does not provide for partial updates which may change updates previously loaded in RAM. Total updates, on the other hand provide the updating data concerning all changes of interest which have occurred since the manufacture of the ROM. Note however that total updates can also be additive in the sense that it is possible for the RAM to contain several total updates relevant to *different* areas.

7.7.4 Application Group Structure

The I-RDS update application utilizes Mode 1.1 operation of the open data application. In this mode, any A group type available for use within the open data application may be utilized for data transmission. The structure of this A type group is shown in Figure 51. Utilizing the 5 bit address code of block 2 of A type open data groups, specific channels are assigned for use. The address code identifies "channel number" (out of 32) to which data are addressed. Specific channels are assigned for the various types of I-RDS updates. The types of updates possible are:

1. Update identifier (Channel 0) - This channel identifies the following information relevant to the current update:
 - a.) The Grid number at the center of the update region (14 bits)
 - b.) The coverage index of the update (number of grids covered) (2 bits).
 - c.) The update length (in bytes)

2. Update data (Channels 1-4) - These channels contain the actual update data proper. Each type of update data is preceded by the address pointer for the data. The data sent is the actual data which must be stored in RAM (See Figure R.13.1). The following types of data may be updated:
 - a.) Station channel number
 - b.) Station call sign (4 byte ASCII code)
 - c.) Station format

3. Erase record (Channels 5-6) - Previously stored records may be entirely erased using this feature. ROM records are indicated by the address pointer only (Channel 5), while RAM records (Channel 6) are indicated by the ASCII call sign of the station to be deleted.

4. New record (Channels 7-9) - An entirely new record may be stored through this type of update. All the data required to establish a new record in contained within the new record update channels.

5. End of message, or EOM (Channel 31) - The hex code FF is transmitted at the end of the update. This may be utilized by the receiver in verifying the proper receipt of the entire update message.

Note: Channels 10-30 are reserved for future use. All unused bits shall be set to a logic 0.

DESCRIPTION	ADDRESS CODE (BLOCK 2)	BLOCK 3 DATA		BLOCK 4 DATA	
		BYTE 1	BYTE 2	BYTE 1	BYTE 2
UPDATE IDENTIFIER	0	GRID (14 bits)	COVERAGE (2 bits)	UPDATE LENGTH	
UPDATE DATA	1	POINTER		CHANNEL	UNUSED
	2	POINTER		BYTE 1, CALL SIGN	BYTE 2, CALL SIGN
	3	POINTER		BYTE 3, CALL SIGN	BYTE 4, CALL SIGN
	4	POINTER		UNUSED	FORMAT
ERASE ROM RECORD	5	POINTER		UNUSED	UNUSED
ERASE RAM RECORD	6	BYTE 1, CALL SIGN	BYTE 2, CALL SIGN	BYTE 3, CALL SIGN	BYTE 4, CALL SIGN
NEW RECORD	7	GRID		CHANNEL	FORMAT
	8	BYTE 1, CALL SIGN	BYTE 2, CALL SIGN	BYTE 3, CALL SIGN	BYTE 4, CALL SIGN
	9	CITY POINTER		UNUSED	
RESERVED FOR FUTURE USE	10-30	RESERVED			
EOM	31	FF	UNUSED	UNUSED	

Figure 51 - I-RDS Open Data Application group structure (Mode 1.1)

7.7.4.1 - Center Grid of updated region: The first 14 bits of block 3 (MSB → LSB) of channel 0 identifies the number of the Grid at the center of the region whose stations' data is being updated. (See sections 7.5, R.9 and R.12.5) This number ranges from 0 to 16383.

Note: 14 bits are required as the standard Grid system contains a total of 9424 Grids.

7.7.4.2 - Coverage index: The width of the area which is addressed by an update may vary. This is provided since the density of stations throughout the continent is not equal. Within a densely populated area with many stations, the update coverage may be kept small (e.g., 1 Grid -- a rectangular area with sides of about 34 miles), whereas a region with very few stations should permit the updating of a much larger geographical region (e.g., 81 Grids -- a rectangular area of sides of about 310 miles). This data is carried in the last two significant bits of block 3 of channel 0.

The coverage index is contained in the last two bits of block 3 of channel 0.. It can have the following values:

00 _b	=	0 =	1 Grid
01 _b	=	1 =	9 Grids (3 by 3)
10 _b	=	2 =	25 Grids (5 by 5)
11 _b	=	3 =	81 Grids (9 by 9)

7.7.4.3 - Update length: This 16-bit code indicates the length (in bytes) of the update message which is to be sent. This number ranges from 0 to 65535.

7.7.4.4 - Pointer: This 16-bit code contains a pointer which references the ROM address which is occupied by the record to be updated. All update data is preceded by such an address except for New Station data, Erase RAM record, and EOM which signifies the end of the update message.

Note 1: The pointer must be multiplied by 4 to get a real address. (See section R.13.1.3)

Note 2: The EOM mark (FF_{16}) can be used to double-check the integrity of the received update data message as it must correlate with the update length. (See section 7.7.4.3)

ANNEX A (normative)

Offset words to be used for group and block synchronization

The offset words are chosen in such a way that the content in the offset register will not be interpreted as a burst of errors equal to or shorter than five bits when rotated in the polynomial shift register (see annex B).

Only eight bits (i.e. d_9 to d_2) are used for identifying the offset words. The remaining two bits (i.e. d_1 and d_0) are set to logical level zero.

The six offset words (A, B, C, C', D, E) of the table below are used for all applications. For MMBS applications an additional offset word E is used to maintain synchronization.

Table A.1

Offset word	Binary value									
	d_9	d_8	d_7	d_6	d_5	d_4	d_3	d_2	d_1	d_0
A	0	0	1	1	1	1	1	1	0	0
B	0	1	1	0	0	1	1	0	0	0
C	0	1	0	1	1	0	1	0	0	0
C'	1	1	0	1	0	1	0	0	0	0
D	0	1	1	0	1	1	0	1	0	0
E ¹⁾	0	0	0	0	0	0	0	0	0	0

The offset words are added (modulo-two) to the checkword $c_9 - c_0$ to generate the modified check-bits: $c'_9 - c'_0$ (see 2.3, Error protection).

¹⁾ Attention is drawn to the fact that, in the USA (see [15] of annex Q), offset word E (binary value = 0) is used in multiples of four blocks, when RDS and MMBS are simultaneously implemented. Offset word E must not be used in RDS implementations corresponding to this specification.

ANNEX B (informative)

Theory and implementation of the modified shortened cyclic code

The data format described in this document uses a shortened cyclic block code, which is given the capability of detecting block-synchronization-slip by the addition (modulo-two) of chosen binary sequences (offset words, see annex A) to the check bits of each codeword [4, 6, 7].

B.1 Encoding procedure

B.1.1 Theory

A definitive description of the encoding of the information is given in 3.2.

The code used is an optimum burst-error-correcting shortened cyclic code [5] and has the generator polynomial:

$$g(x) = x^{10} + x^8 + x^7 + x^5 + x^4 + x^3 + 1$$

Each block consists of 16 information bits and 10 check bits. Thus the block length is 26 bits.

The 10-bit checkword of the basic shortened cyclic code may be formed in the usual way, i.e. it is the remainder after multiplication by x^{n-k} (where $n-k$ is the number of check bits, 10 here), and then division (modulo-two) by the generator polynomial $g(x)$, of the message vector.

Thus if the polynomial $m(x) = m_{15}x^{15} + m_{14}x^{14} + \dots + m_1x + m_0$

(where the coefficients m_n are 0 or 1), represents the 16-bit message vector, the basic code vector $v(x)$ is given by:

$$v(x) = m(x)x^{10} + \frac{m(x)x^{10}}{g(x)} \Bigg| \text{mod } g(x)$$

The transmitted code vector is then formed by the addition (modulo-two) of the 10-bit offset word, $d(x)$ (see annex A) to the basic code vector $v(x)$.

Thus the transmitted code vector, $c(x)$, is given by:

$$\begin{aligned} c(x) &= d(x) + v(x) \\ &= d(x) + \frac{m(x)x^{10}}{g(x)} \Bigg| \text{mod } g(x) \end{aligned}$$

The code vector is transmitted m.s.b. first, i.e. information bits $c_{25}x^{25}$ to $c_{10}x^{10}$, followed by modified check bits c_9x^9 to c_0x^0 .

The encoding process may alternatively be considered in terms of its generator matrix G which is derived from the generator polynomial. The 16 information bits are expressed as a 16 x 1 column matrix and multiplied by the generator matrix to give the information bits and check bits. The complete transmitted code vector is then formed by the addition of the offset word, $d(x)$.

$$G = \begin{pmatrix} 1 & 0 & 0 & 0 & 0 & 0 & 0 & 0 & 0 & 0 & 0 & 0 & 0 & 0 & 0 & 0 & 0 & 0 & 1 & 1 & 1 & 0 & 1 & 1 & 1 \\ 0 & 1 & & & & & & & & & & & & & & & & & 0 & 1 & 0 & 1 & 1 & 1 & 0 & 0 & 1 & 1 & 1 \\ 0 & & 1 & & & & & & & & & & & & & & & & 0 & 1 & 1 & 1 & 0 & 1 & 0 & 1 & 1 & 1 & 1 \\ 0 & & & 1 & & & & & & & & & & & & & & & 0 & 1 & 1 & 0 & 0 & 0 & 0 & 1 & 0 & 1 & 1 \\ 0 & & & & 1 & & & & & & & & & & & & & & 0 & 1 & 1 & 0 & 1 & 0 & 1 & 1 & 0 & 0 & 1 \\ 0 & & & & & 1 & & & & & & & & & & & & & 0 & 1 & 1 & 0 & 1 & 1 & 1 & 0 & 0 & 0 & 0 \\ 0 & & & & & & 1 & & & & & & & & & & & & 0 & 0 & 1 & 1 & 0 & 1 & 1 & 1 & 0 & 0 & 0 \\ 0 & & & & & & & 1 & & & & & & & & & & & 0 & 0 & 0 & 1 & 1 & 0 & 1 & 1 & 1 & 0 & 0 \\ 0 & & & & & & & & 1 & & & & & & & & & & 0 & 0 & 0 & 0 & 1 & 1 & 0 & 1 & 1 & 1 & 0 \\ 0 & & & & & & & & & 1 & & & & & & & & & 0 & 0 & 0 & 0 & 0 & 1 & 1 & 0 & 1 & 1 & 1 \\ 0 & & & & & & & & & & 1 & & & & & & & & 0 & 1 & 0 & 1 & 1 & 0 & 0 & 0 & 0 & 1 & 1 & 1 \\ 0 & & & & & & & & & & & 1 & & & & & & & 0 & 1 & 1 & 1 & 0 & 1 & 1 & 1 & 1 & 1 & 1 & 1 \\ 0 & & & & & & & & & & & & 1 & & & & & & 0 & 1 & 1 & 0 & 0 & 0 & 0 & 0 & 0 & 0 & 1 & 1 \\ 0 & & & & & & & & & & & & & 1 & & & & & 0 & 1 & 1 & 0 & 1 & 0 & 1 & 1 & 1 & 0 & 1 & 0 \\ 0 & & & & & & & & & & & & & & 1 & & & & 1 & 0 & 1 & 1 & 0 & 1 & 1 & 1 & 0 & 0 & 1 & 0 \\ 0 & 0 & 0 & 0 & 0 & 0 & 0 & 0 & 0 & 0 & 0 & 0 & 0 & 0 & 0 & 0 & 0 & 0 & 1 & 0 & 1 & 1 & 0 & 1 & 1 & 1 & 0 & 0 & 1 \end{pmatrix}$$

Figure B.1: Generator matrix of the basic shortened cyclic code in binary notation

Thus,

$$(m_{15}x^{15} + m_{14}x^{14} + \dots + m_0) G = m_{15}x^{25} + m_{14}x^{24} + \dots + m_0x^{10} + c_9x^9 + c_8x^8 + \dots$$

where

$$\begin{aligned} c_9 &= (m_{15} \times 0) \oplus (m_{14} \times 1) \oplus (m_{13} \times 1) \oplus \dots \oplus (m_1 \times 1) \oplus (m_0 \times 0) \\ c_8 &= (m_{15} \times 0) \oplus (m_{14} \times 0) \oplus (m_{13} \times 1) \oplus \dots \oplus (m_1 \times 1) \oplus (m_0 \times 1), \text{ etc.} \\ &(\oplus \text{ indicates modulo-two addition}). \end{aligned}$$

The check bits of the code vector are thus readily calculated by the modulo-two addition of all the rows of the generator matrix for which the corresponding coefficient in the message vector is "1".

Thus for the message vector:

$$m(x) = 0000000000000001$$

The corresponding code vector is:

$$v(x) = 00000000000000010110111001$$

which may be seen to be the bottom row of the generator matrix.

After adding the offset word say $d(x) = 0110011000$ the transmitted code vector is:

$$c(x) = 00000000000000010000100001$$

Similarly for the all "1"s message vector:

$$m(x) = 1111111111111111$$

it follows that:

$$v(x) = 11111111111111110011001101$$

which on adding an offset word $d(x) = 0110011000$ becomes:

$$c(x) = 11111111111111110101010101$$

B.1.2 Shift-register implementation of the encoder

Figure B.2 shows a shift-register arrangement for encoding the transmitted 26-bit blocks. The encoding procedure is as follows:

- a) At the beginning of each block clear the 10-bit encoder shift-register to the "all-zeroes" state.
- b) With gates A and B open (i.e. data passes through) and gate C closed (data does not pass through) clock the 16-bit message string serially into the encoder and simultaneously out to the data channel.
- c) After all the 16 message bits for a block have been entered, gates A and B are closed and gate C opened.
- d) The encoder shift-register is then clocked a further 10 times to shift the checkword out to the data channel through a modulo-two adder where the offset word, $d(x)$, appropriate to the block is added serially bit-by-bit to form the transmitted checkword.
- e) The cycle then repeats with the next block.

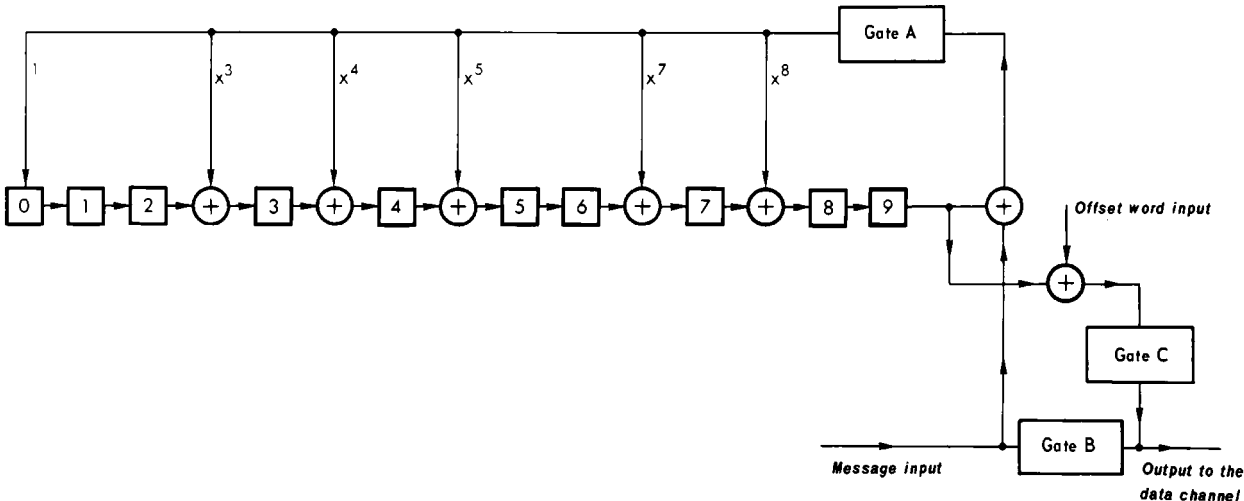

Figure B.2: Shift-register implementation of the encoder

Thus $\bar{s} = \bar{z}H = 1111011000$

The other syndromes can be calculated in the same way. The syndromes corresponding to offset words A to D calculated using the matrix of figure B.3, are shown in the table below:

Table B.1

Offset	Offset word $d_9, d_8, d_7, \dots, d_0$	Syndrome $S_9, S_8, S_7, \dots, S_0$
A	0011111100	1111011000
B	0110011000	1111010100
C	0101101000	1001011100
C'	1101010000	1111001100
D	0110110100	1001011000

B.2.2 Implementation of the decoder

There are several methods using either hardware or software techniques for implementing the decoder. One possible method is described below.

Figure B.4 shows a shift-register arrangement for decoding the transmitted 26-bit blocks and performing error-correction and detection.

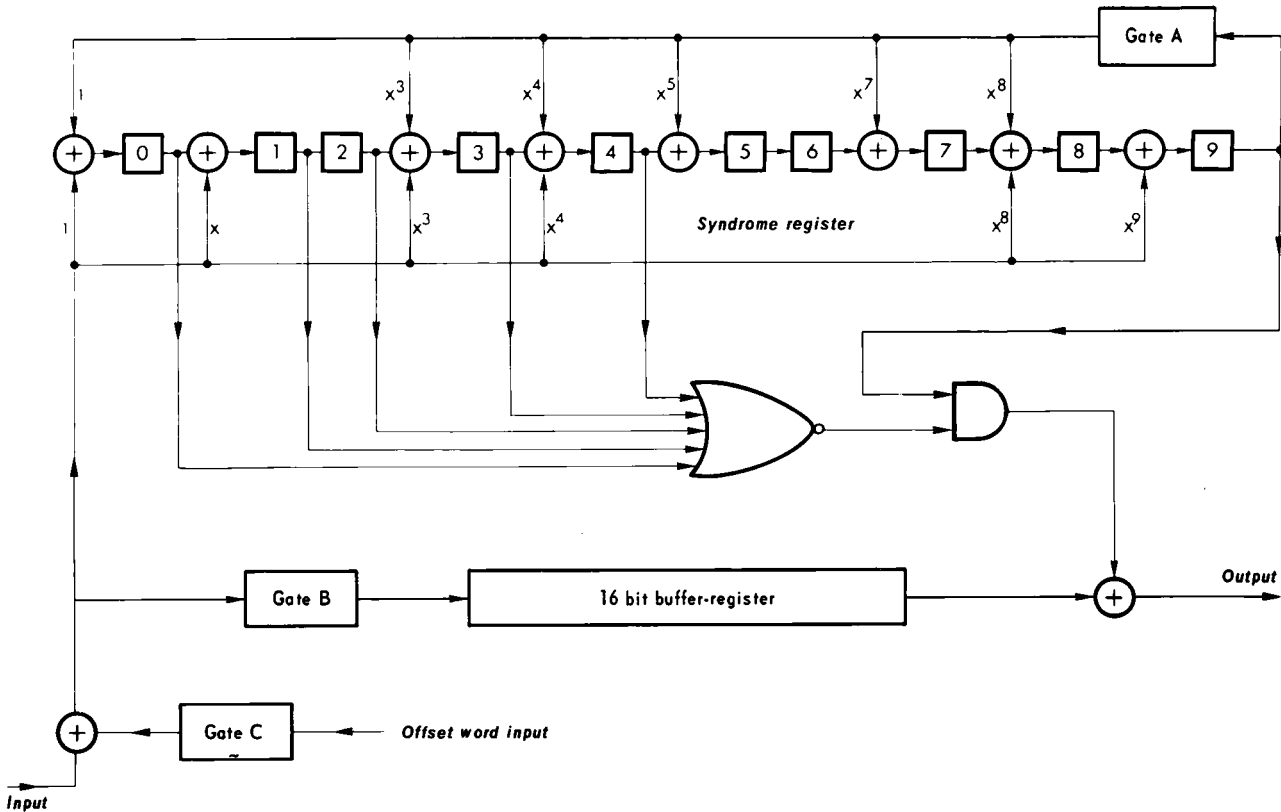

Figure B.4: Shift-register implementation of the decoder

The decoding procedure is as follows, assuming that in this explanation group and block synchronization have already been acquired (see annex C):

- a) At the beginning of each block the 10-bit syndrome-register and the 16-bit buffer-register are cleared to the "all-zeroes" state.
- b) The 16 information bits are fed into the syndrome- and buffer-registers. Gates A and B are open (conducting), and Gate C is closed (not conducting).
- c) With Gate B closed and Gate C open the 10 check-bits are fed into the syndrome-register. The offset word appropriate to the block is then subtracted from the checkword serially bit-by-bit at the modulo-two adder at the input to the decoder.
- d) The 16 information bits in the buffer-register are clocked to the output and the contents of the syndrome-register are rotated with Gate A open.
- e) When the five left-most stages in the syndrome-register are all zero a possible error burst with a maximum length of five bits must lie in the five right-hand stages of the register.
- f) Gate A is closed and the contents of the syndrome register are added bit-by-bit to the bit-stream coming from the buffer-register. If the five left-most stages do not become all zero before the buffer-register is empty, either an uncorrectable error has occurred or the error is in the check-bits.
- g) The cycle then repeats with the next block.

In this implementation of the decoder, in addition to the connections to the syndrome register corresponding to the coefficients of the generator polynomial, $g(x)$, there is a second set of connections to perform automatic premultiplication of the received message by x^{325} modulo $g(x)$. This is necessary because the code has been shortened from its natural cyclic length of 341 bits. The remainder of x^{325} modulo $g(x)$ is: $x^9 + x^8 + x^4 + x^3 + x + 1$, and the second set of connections to the syndrome register may be seen to correspond to the coefficients in this remainder.

Reference [4] of annex Q gives a further explanation of this decoding technique.

ANNEX C (informative)

Implementation of group and block synchronization using the modified shortened cyclic code

C.1 Theory

C.1.1 Acquisition of group and block synchronization

To acquire group and block synchronization at the receiver (for example when the receiver is first switched on, on tuning to a new station, or after a prolonged signal-fade) the syndrome \bar{s} must be calculated for each received 26-bit sequence. That is, on every data-clock pulse the syndrome of the currently stored 26-bit sequence (with the most recently received data bit at one end and the bit received 26 clock pulses ago at the other) is calculated on every clock pulse.

This bit-by-bit check is done continuously until two syndromes corresponding to valid offset words, and in a valid sequence for a group i.e. [A, B, C (or C'), D] are found $n \times 26$ bits apart (where $n = 1, 2, 3$, etc.). When this is achieved, the decoder is synchronized and the offset words which are added to the parity bits at the transmitter are subtracted at the receiver before the syndrome calculation for error correction/ detection is done (see annex B).

C.1.2 Detection of loss of synchronization

It is very important to detect loss of synchronization as soon as possible. One possibility is to check the syndrome continuously as for acquisition of synchronization. However, errors in the channel will make it difficult to continuously receive the expected syndromes, and therefore the decision must be based on the information from several blocks, e.g. up to 50 blocks. Another possibility is to check the number of errors in each block and base the decision on the number of errors in 50 blocks.

One possibility for detecting block synchronization slips of one bit is to use the PI code, which does not usually change on any given transmission. If the known PI code is received correctly, but is found to be shifted one bit to the right or to the left, then a one bit clock-slip is detected. The decoder can then immediately correct the clock-slip.

C.2 Shift register arrangement for deriving group and block synchronization information

There are several methods using either hardware or software techniques for deriving group and block synchronization information. One possible method is described below. Figure C.1 shows a block diagram of a shift-register arrangement for deriving group and block synchronization information from the received data stream. It may be seen to comprise five main elements:

- a) a 26-bit shift-register which may either act as a straight 26-bit delay (A/B input selector high) or as a recirculating shift-register (A/B input selector low);
- b) a polynomial division circuit comprising a 10-bit shift-register with feedback taps appropriate to the generator polynomial, $g(x)$, described in 2.3 and annex B;
- c) a combinational logic circuit with five outputs indicating the presence of the "correct" syndromes resulting from the five offset words A, B, C, C' and D;
- d) a fast-running clock operating with a frequency of at least 33.5 kHz;
- e) a modulo-28 counter with endstops, decoding for states 0, 1 and 27, and associated logic gates 1 to 3 and flip-flops 1 to 3 (FF1 to FF3).

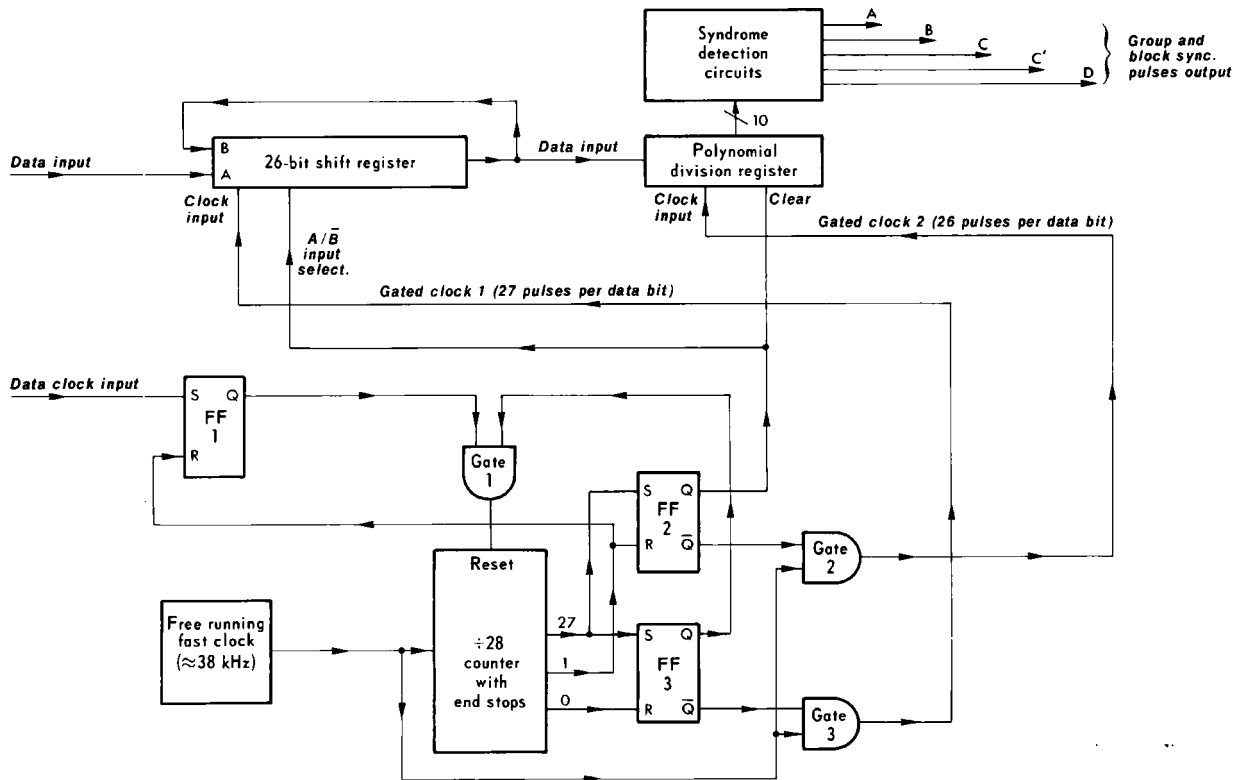

* The circuit of this register is represented in figure B.2 (annex B)

Figure C.1: Group and block synchronization detection circuit

Assume that the modulo-28 counter is initially on its top endstop (state 27). Then FF2 and FF3 are set and FF1 is reset. The gated clocks to the 26-bit shift-register and the polynomial division circuit (gated clocks 1 and 2) are inhibited and the division circuit shift-register is cleared.

On the next data clock pulse FF1 is set, which in turn resets the modulo-28 counter to state 0. This resets FF3 which enables the fast clock (gated clock 1) to the 26-bit shift-register. This has its input A selected and thus the new data bit is entered into its left-hand end; the shift-register of the polynomial division circuit remains cleared and not clocked. On the next fast clock-pulse FF1 is reset ready for the next data clock-pulse.

Before then, however, the fast clock circulates the 26 bits currently stored in the shift-register around, and thus passes them serially into the polynomial division shift-register where the syndrome (i.e. the remainder of the polynomial division) is calculated. If these 26 bits happened to be a valid code-word then the syndrome would be $x^{10}d(x)$ modulo $g(x)$, e.g. if the offset word is $d(x) = 0011111100$, then the corresponding "correct" syndrome for that block would be 0101111111.

It should be noted that the syndromes obtained with this polynomial division register are different from that resulting from the matrix of figure B.3 or the circuit of figure B.4. The syndromes corresponding to offset words A to D are shown in the table below.

Table C.1

Offset	Offset word $d_9, d_8, d_7, \dots, d_0$	Syndrome $S_9, S_8, S_7, \dots, S_0$
A	0011111100	0101111111
B	0110011000	0000001110
C	0101101000	0100101111
C'	1101010000	1011101100
D	0110110100	1010010111

When the syndrome corresponding to one of the five offset words is found, a block synchronization pulse is given out of the appropriate one of the five outputs of the combinational logic circuit. With high probability (99.5%) this will only occur when the stored 26 bits are a complete error-free block.

This decoding process must all be achieved in under one data-bit period ($\approx 842 \mu\text{s}$).

On the next data-clock pulse the whole process repeats with the new data bit in the leftmost cell of the 26-bit shift-register and all the other bits shifted along one place to the right. Thus a block synchronization pulse will usually be derived one every 26 bits and will mark the end of each received block.

Moreover, since the circuit identifies which offset word A, B, C, C' or D was added to the block, group synchronization is also achieved.

These group and block synchronization pulses cannot be used directly because with this system false synchronization pulses due to data mimicking or errors will occur. On average (with random data) false synchronization pulses occur once in every 1024/5 bits or approximately six times per second. Similarly, when errors occur, block synchronization pulses will be missed because even with correct block synchronization one of the "correct" syndromes corresponding to one of the five offset words will not result.

Thus it is necessary to have some sort of block synchronization flywheel to eliminate spurious synchronization pulses and fill in the missing ones. This could be achieved with any one of the standard strategies, but should take into account the fixed cyclic rhythm of occurrence of the offset words i.e. A, B, C (or C'), D, A, B ..., etc.

ANNEX D (normative)

Program identification codes and Extended country codes

D.1 PI structure

Code assignments for bits b_{11} to b_0 should be decided by relevant authorities in each country individually.

Note: PI structure for North America begins at section D.6.

b_{15}				b_{12}				b_{11}				b_8				b_7				b_4				b_3				b_0							

Figure D.1: PI structure

Bits b_{15} to b_{12} : Country code

Codes are indicated on the map of figure D.3 and table D.1. Code 0 (Hex) shall not be used for country identification.

Bits b_{11} to b_8 : Program type in terms of area coverage

Codes are given in D.4.

Bits b_7 to b_0 : Program reference number

Codes are given in D.5.

General remark: All codes are binary-coded Hex numbers.

Codes shall be assigned in such a way that automatic search tuning to other transmitters radiating the same program can locate the same program identification code, i.e. all 16 bits shall be identical. In cases where during a few program hours a network is split to radiate different programs, each of these programs shall carry a different program identification code, by using different coverage-area codes.

D.2 Extended country codes

Extended country codes (see table D.1) shall be transmitted in type 1A groups to render the country code in bits b_{15} to b_{12} of the PI code unique. The Extended country code (ECC) is carried in Variant 0 of Block 3 of type 1A groups and consists of eight bits. This Variant should be transmitted at least once every minute.

The bit allocation of the Extended country codes is given in figure D.2, and the codes are given in table D.1.

Usage	Bit allocation in Block 3															
Group type 1A	b_{15}	b_{14}	b_{13}	b_{12}	b_{11}	b_{10}	b_9	b_8	b_7	b_6	b_5	b_4	b_3	b_2	b_1	b_0
Variant code 0	LA	0	0	0	OPC				Extended Country Code							

$\underbrace{\hspace{10em}}_{\text{Radio Paging } ^1}$
 $\underbrace{\hspace{12em}}_{\text{Usage code}}$
 $\underbrace{\hspace{14em}}_{\text{Linkage Actuator } ^2}$

¹⁾ The Operator Code for Radio Paging using the Enhanced Paging Protocol is defined in annex M (see M 3.2.2 and M.3.2.4).

²⁾ The Linkage Actuator is defined in the Method for linking RDS program services (see 3.2.1.8.3).

Figure D.2: Structure of Variant 0 of Block 3 of Type 1A groups (Extended Country Codes)

D.3 Country codes



Figure D.3: Correspondence between geographical locations and the symbols used for the various countries

Table D.1
Symbols used for ECC and PI country codes for the countries in the European Broadcasting Area¹

<i>Country</i>	<i>ISO code</i>	<i>ECC and Country code</i>			<i>Country</i>	<i>ISO code</i>	<i>ECC and Country code</i>		
Albania	AL	E0	9		Italy	IT	E0	5	
Algeria	DZ	E0	2		Jordan	JO	E1	5	
Andorra	AD	E0	3		Latvia	LV	E3	9	
Austria	AT	E0	A		Lebanon	LB	E3	A	
Azores (Portugal)	PT	E4	8		Libya	LY	E1	D	
Belgium	BE	E0	6		Liechtenstein	LI	E2	9	
					Lithuania	LT	E2	C	
					Luxembourg	LU	E1	7	
					Macedonia	MK	E3	4	
					Madeira (Portugal)	PT	E4	8	
Belarus	BY	E3	F		Malta	MT	E0	C	
Bosnia Herzegovina	BA	E4	F		Moldova	MD	E4	1	
Bulgaria	BG	E1	8		Monaco	MC	E2	B	
Canaries (Spain)	ES	E2	E		Morocco	MA	E2	1	
Croatia	HR	E3	C						
Cyprus	CY	E1	2		Netherlands	NL	E3	8	
Czech Republic	CZ	E2	2		Norway	NO	E2	F	
					Palestine	PS	E0	8	
					Poland	PL	E2	3	
Denmark	DK	E1	9		Portugal	PT	E4	8	
Egypt	E.G.	E0	F		Romania	RO	E1	E	
Estonia	EE	E4	2		Russian Federation	RU	E0	7	
Faroe (Denmark)	DK	E1	9		San Marino	SM	E1	3	
Finland	FI	E1	6		Slovakia	SK	E2	5	
France	FR	E1	F		Slovenia	SI	E4	9	
					Spain	ES	E2	E	
Germany	DE	E0	D		Sweden	SE	E3	E	
	or	E0	1		Switzerland	CH	E1	4	
Gibraltar (United Kingdom)	GI	E1	A		Syrian Arab Republic	SY	E2	6	
Greece	GR	E1	1		Tunisia	TN	E2	7	
Hungary	HU	E0	B		Turkey	TR	E3	3	
Iceland	IS	E2	A		Ukraine	UA	E4	6	
Iraq	IQ	E1	B		United Kingdom	GB	E1	C	
Ireland	IE	E3	2		Vatican City State	VA	E2	4	
Israel	IL	E0	4		Yugoslavia	YU	E2	D	

ECC	1	2	3	4	5	6	7	8	9	A	B	C	D	E	F
E 0	DE	DZ	AD	IL	IT	BE	RU	PS	AL	AT	HU	MT	DE		E.G.
E 1	GR	CY	SM	CH	JO	FI	LU	BG	DK	GI	IQ	GB	LY	RO	FR
E 2	MA	CZ	PL	VA	SK	SY	TN		LI	IS	MC	LT	YU	ES	NO
E 3	IE	TR	MK				NL	LV	LB		HR		SE	BY	
E 4	MD	EE				UA		PT	SI						BA

Hex code for Variant 0 in Block 3 of Group type 1A, Bits b₃ to b₀
Hex code for Variant 0 in Block 3 of Group type 1A, Bits b₇ to b₄

¹ The country codes and Extended country codes for countries outside the European Broadcasting Area are given in annex N.

D.4 Coverage-area codes

Bits b_{11} to b_8 :

- I: (International) The same program is also transmitted in other countries.
- N: (National) The same program is transmitted throughout the country.
- S: (Supra-regional) The same program is transmitted throughout a large part of the country.
- R1 . . . R12: (Regional) The program is available only in one location or region over one or more frequencies, and there exists no definition of its frontiers.
- L: (Local) Local program transmitted via a single transmitter only during the whole transmitting time.

Hex-coding rules for bits b_{11} to b_8 :

Table D.2

Area coverage code	L	I	N	S	R1	R2	R3	R4	R5	R6	R7	R8	R9	R10	R11	R12
HEX	0	1	2	3	4	5	6	7	8	9	A	B	C	D	E	F

D.5 Program reference number

Bits b_7 to b_0 :

Decimal Numbers *hex*

00 00 Not assigned

01 to 255 01 to FF In order to clearly identify the different program families, these codes should, in each country, be systematically assigned and generically linked to the program families.

D.6 PI Coding for North America

PI codes in North America are issued and utilized differently than the rest of the world. In areas licenced by the Federal Communications Commission (except Guam), PI codes are calculated by the stations call letters. This gives each station a unique PI code without the need for any outside coordination. These PI codes, as well as those assigned in the 'C' and 'F' ranges for Canada and Mexico respectively, do not make use of coverage area codes (section D.4). Coverage area codes are only valid for the 'B', 'D', and 'E' blocks of PI codes. Broadcasters and receiver manufacturers must make note of this subtle, yet significant, difference of the RBDS standard.

D.6.1 Call letter conversion method

NOTE: Call letters or slogan to be displayed by the receiver are sent using the PS (program service) data.

- 1) Assign decimal values to last 3 letters of call letters:

Table D.3

LETTER	DECIMAL VALUE	LETTER	DECIMAL VALUE
A	0	N	13
B	1	O	14
C	2	P	15
D	3	Q	16
E	4	R	17
F	5	S	18
G	6	T	19
H	7	U	20
I	8	V	21
J	9	W	22
K	10	X	23
L	11	Y	24
M	12	Z	25

- 2) Assign weighted value according to call letter's position and add together to obtain a DECIMAL value for last 3 letters.

K 3rd letter position 2nd letter position 1st letter position
 W 3rd letter position 2nd letter position 1st letter position

3rd letter position x 676
 + 2nd letter position x 26
 + 1st letter position
 decimal value for 3 letters = DECIMAL

- 3) If station begins with K, HEX {DECIMAL +4096} (value obtained above + 4096) to obtain four digit PI code. However, if station begins with W, HEX {DECIMAL +21672} to obtain four digit PI code.

IF K...	HEXADECIMAL +4096]	=	FOUR DIGIT PI CODE
IF W...	HEXADECIMAL +21672]	=	FOUR DIGIT PI CODE

EXCEPTIONS TO ABOVE ASSIGNMENTS:

- 1) CALL LETTERS THAT MAP TO PI CODES = _0_. European receivers will treat a PI code that has a second nibble of zero as a local station (unique broadcast) and will not AF switch. If a station's call letters map to a PI code = _0_, the PI code assignment needs to be reassigned into the A __ group as follows:

P1 0 P3 P4 → A P1 P3 P4: Examples: 1045 → A145; 30F2 → A3F2; 80A1 → A8A1; etc.

- 2) CALL LETTERS THAT MAP TO PI CODES = __00. If station's PI code ends with 00h, some European receivers will go into a test mode. Therefore, 00h will be reassigned into the A F __ group as follows:

P1 P2 0 0 → A F P1 P2: Examples: 1C00 → AF1C; 3200 → AF32; 8C00 → AF8C ; etc.

NOTE: For 9 special cases 1000,2000,...,9000 a double mapping occurs utilizing exceptions 1 and 2:
1000→A100→AFA1;2000→A200→AFA2; ... ;8000→A800→AFA8;9000→A900→AFA9

- 3) TWO STATIONS CARRY THE IDENTICAL PROGRAMMING (example WYAY and WYAI in Atlanta, Georgia). These stations will need to assign the same PI code for both stations. The radio will need an identical PI code match to switch to the alternate frequency. The call letters can still be displayed independently with the PS information. Therefore, either the mapping of WYAY PI code = 4F78 or WYAI PI code = 4F68 will need to be used.
- 4) 3-LETTER-ONLY CALL LETTERS (example KYA in San Francisco). For 3 letter call sign stations, a mapping of pre-assigned PI codes is shown in Table D.4, TABLE OF PI CODE POSSIBILITIES. The mapping of 3-letter-only call letters is reserved in PI codes ranging from 9950 to 9EFF.
- 5) NATIONALLY-LINKED RADIO STATIONS CARRYING DIFFERENT CALL LETTERS (example NPR). These stations will need to be assigned a PI code with a first nibble of B (B_01 to B_FF, D_01 to D_FF, E_01 to E_FF). NOTE: Nibble 2 can only be filled with 1 through F. If a 0 is used, some receivers may not switch to Alternate Frequencies.

Table D.4
TABLE OF PI CODE POSSIBILITIES

<u>HEX CODE = FOUR DIGIT PI CODE</u>
HEX[0000-0FFF] RESERVED

<u>CALL LETTERS(K) CODE</u>	<u>DECIMAL + 4096</u>	<u>HEX CODE = FOUR DIGIT PI</u>
KAAA	0 + 4096 = 4096	HEX[4096] = 1000
KAAB	1 + 4096 = 4097	HEX[4097] = 1001
:	:	:
:	:	:
KZZY	17574 + 4096 = 21670	HEX[21670] = 54A6
KZZZ	17575 + 4096 = 21671	HEX[21671] = 54A7

<u>CALL LETTERS(W) CODE</u>	<u>DECIMAL + 21672</u>	<u>HEX CODE = FOUR DIGIT PI</u>
WAAA	0 + 21672 = 21672	HEX[21672] = 54A8
WAAB	1 + 21672 = 21673	HEX[21673] = 54A9
:	:	:
:	:	:
WZZY	17574 + 21672 = 39246	HEX[39246] = 994E
WZZZ	17575 + 21672 = 39247	HEX[39247] = 994F

<u>CALL LETTERS MAPPING TO _0_</u>	<u>HEX CODE = FOUR DIGIT PI CODE</u>
1000	A100
1001	A101
:	:
90FF	A9FF

<u>CALL LETTERS MAPPING TO _ _ 0 0 CODE</u>	<u>HEX CODE = FOUR DIGIT PI</u>
1000 A100	AFA1
1100	AF11
1200	AF12
:	:
1F00	AF1F
2000 A200	AFA2
2100	AF21
2200	AF22
:	:
AF00	AFAF

Table D.4 (continued)
TABLE OF PI CODE POSSIBILITIES

<u>CANADA RADIO STATIONS</u> <u>CODE</u>	<u>HEX CODE = FOUR DIGIT PI</u>
?	C000
?	C001
:	:
?	CFFF

<u>MEXICO RADIO STATIONS</u> <u>CODE</u>	<u>HEX CODE = FOUR DIGIT PI</u>
?	F000
?	F001
:	:
?	FFFF

<u>NATIONALLY/REGIONALLY-LINKED</u> <u>RADIO STATIONS</u> ² <u>CODE</u>	<u>HEX CODE = FOUR DIGIT PI</u>
NPR	B_01
CBC English	B_02
CBC French	B_03
?	B_04
:	:
?	B_FF
?	D_01
?	D_02
:	:
?	D_FF
?	E_01
?	E_02
:	:
?	E_FF

²In the United States, these codes will be allocated by the administrators of the National Radio Systems Committee. The use of coverage area codes as outlined in section D.4 applies only to this block of codes.

NOTE: The scheme outlined in this table will map all possible K___, W___, 3-LETTER-ONLY CALL LETTERS, CALL LETTERS MAPPING TO _0_-, CALL LETTERS MAPPING TO __00, and NATIONALLY-LINKED RADIO STATIONS into a four digit hex PI code. Radio will distinguish AM/FM if AM RDS PI codes need to become established.

Table D.4 (continued)
TABLE OF PI CODE POSSIBILITIES

3 LETTER ONLY CALL LETTERS					
CALL	PI	CALL	PI	CALL	PI
KBW	99A5	KOY	9992	WHO	9978
KCY	99A6	KPQ	9993	WHP	999C
KDB	9990	KQV	9964	WIL	999D
KDF	99A7	KSD	9994	WIP	997A
KEX	9950	KSL	9965	WIS	99B3
KFH	9951	KUJ	9966	WJR	997B
KFI	9952	KUT	9995	WJW	99B4
KGA	9953	KVI	9967	WJZ	99B5
KGB	9991	KWG	9968	WKY	997C
KGO	9954	KXL	9996	WLS	997D
KGU	9955	KXO	9997	WLW	997E
KGW	9956	KYW	996B	WMC	999E
KGY	9957	WBT	9999	WMT	999F
KHQ	99AA	WBZ	996D	WOC	9981
KID	9958	WDZ	996E	WOI	99A0
KIT	9959	WEW	996F	WOL	9983
KJR	995A	WGH	999A	WOR	9984
KLO	995B	WGL	9971	WOW	99A1
KLZ	995C	WGN	9972	WRC	99B9
KMA	995D	WGR	9973	WRR	99A2
KMJ	995E	WGY	999B	WSB	99A3
KNX	995F	WHA	9975	WSM	99A4
KOA	9960	WHB	9976	WWJ	9988
KOB	99AB	WHK	9977	WWL	9989

D.6.2 Examples of assigning PI codes from Call letters:

$$\begin{array}{r} \text{STATION 1: KGTV} \\ \text{G} = 6 \times 676 = 4056 \\ \text{T} = 19 \times 26 = 494 \\ \text{B} = 1 \times \underline{\quad\quad} = \underline{\quad\quad} \\ \phantom{\text{B}} = 4551 \end{array}$$

SINCE STATION BEGINS WITH K: $4551 + 4096 = 8647 = \text{STATION DECIMAL VALUE}$
HEX [8647] = 21C7 = KGTV'S PI CODE

$$\begin{array}{r} \text{STATION 2: WKTI} \\ \text{K} = 10 \times 676 = 6760 \\ \text{T} = 19 \times 26 = 494 \\ \text{I} = 8 \times \underline{\quad\quad} = \underline{\quad\quad} \\ \phantom{\text{I}} = 7262 \end{array}$$

SINCE THIS STATION BEGINS WITH W: $7262 + 21672 = 28934 = \text{STATION DECIMAL VALUE}$
HEX [28934] = 7106 = WKTI'S PI CODE

TO CHECK HEX CODE:

$$\begin{array}{r} \text{4TH DIGIT} \times 4096 \\ + \text{3RD DIGIT} \times 256 \\ + \text{2ND DIGIT} \times 16 \\ + \text{1ST DIGIT} \times 1 \\ \hline \text{SHOULD EQUAL STATION DECIMAL VALUE} \end{array}$$

EXAMPLES OF CHECKS:

KGTV'S CHECK:
PI = 21C7, FROM STATION DECIMAL VALUE OF 8647

$$\begin{array}{r} 2 \times 4096 \\ + 1 \times 256 \\ + 12 \times 16 \\ + 7 \times 1 \\ \hline = 8647 = \text{STATION DECIMAL VALUE} \end{array}$$

WKTI CHECK:
PI = 7106, FROM STATION DECIMAL VALUE OF 28934

$$\begin{array}{r} 7 \times 4096 \\ + 1 \times 256 \\ + 0 \times 16 \\ + 6 \times 1 \\ \hline = 28934 = \text{STATION DECIMAL VALUE} \end{array}$$

D.6.3 Application: Receiver functionality to PI code assignments

PI code usage for North America differs from that defined in the CENELEC RDS standard. The RDS standard accepts the usage of coverage area codes for all possible PI codes (see D.4 COVERAGE AREA CODES). Within North America coverage area codes are recognized only in the following blocks:

- B_01 to B_FFF
- D_01 to D_FF
- E_01 to E_FF

All other PI codes do not make use of coverage area codes and must be handed as such within the receiver.

Some current European receivers store PI codes into presets in addition to storing frequencies into presets. This function is to recognize the broadcast first by program rather than frequency. Thus, if a preset is pushed and the PI code has changed, the European RDS receivers would not recognize the new PI code and go into a PI search.

EBU DOC TECH 3260 January 1990 Chapter 4 pg. 49 states:

If however the PI code changes completely, the receiver should initiate a PI search for a frequency whose PI code exactly matches the PI code of the original tuned frequency. Failing an exact PI code match, the receiver should search for a PI code differing only in the regional element (bits 5-8) from the original PI code. If neither of these criterion are met, the receiver should remain on the original tuned frequency.

Therefore, since call letters are used to create the PI code, the receiver would have to do a PI search every time a station would change call letters or a preset is pushed in a new listening area having a station at the same frequency as the preset station. For PI codes < B000h, future receivers could check the AF list associated to a preset and if no AF's are acceptable, a PI search could be initiated. If no identical PI is found, the receiver should return to the original tuned frequency and accept the new PI code.

If a PI search is performed, the regional variant search (the second search to match PI codes differing only in bits 5-8) should be eliminated in a PI search if the tuned PI is below B000h, or within the ranges of C000 to CFFF, and F000 to FFFF.

If a feature similar to European regional variants is desired, a grouping in the B, D, and E blocks could be designated as follows:

If NPR broadcasts break off national programming to go local for a period of time, it could be assigned a PI of B_01. NOTE: Cannot use 0 as the second nibble because current receivers will not search for AF's: therefore use 4-F for indication of a variant. If no AF's or identical PI's are found via the AF list or an identical PI search, the receiver could, while tuned to NPR station 1 (PI=B101), accept a variant NPR station 2 whose PI varies only in the second nibble (bits 5-8). Thus B201, B301, B401, . . . could be accepted.

PI codes starting with the B, D, and E nibbles yield 765 possibilities for "regional" programming. These PI codes will be shared by the United States, Canada, and Mexico. The problem here becomes that a "telephone book" needs to be kept; however, there should not be too many broadcasts that fit in this category and not many would be used.

ANNEX E (normative)

Character definition for Program Service name, Program Type Name, RadioText and alphanumeric Radio Paging

Three different alphanumeric character repertoires have been defined; they are reproduced in figures E.1 to E.3. Taken together, they permit the composition of texts indicating the name of the program service and the constitution of radio-data messages or alphanumeric paging calls, and they satisfy all the known requirements of the EBU Active Members as regards radio-data transmission. The three code-tables each contain almost all the characters in the international reference version of ISO Publication 646¹⁾. The same codes have been given to each of these characters in all three tables. Care has been taken in the design of the coding tables to ensure that it will be possible to satisfy all the requirements within large geographical areas with each repertoire, and it is therefore likely that some receivers will be equipped to display only the characters included in one of the three repertoires. Nonetheless, it will be necessary to provide information identifying the repertoire in use, in order to ensure that the display corresponds as closely as possible to the intentions of the broadcasting organization when received on a receiver able to display characters from more than one repertoire.

The repertoire tables were designed by the EBU [12] with the view to cover the requirements satisfying the use of languages within the European Broadcasting Area. However a compromise had to be made to keep these tables small in size. As a consequence of this, one or the other character from a particular language was left out, because it is possible to substitute it by another. For example, in Greek, small theta (θ) should be substituted by capital theta (Θ).

In accordance with the practice in the videotext service, where more than one character repertoire is defined also, control codes have therefore been allocated to distinguish between the basic (G0) and two auxiliary (G1 and G2) code-tables. The selection of the required code-table is controlled in videotext by the transmission of the corresponding repertoire control characters; SI (0/15), SO (0/14) and LS2 (1/11 followed by 6/14)²⁾. In radio-data, it is controlled by the transmission of one of the following pairs of repertoire control characters:

- 0/15, 0/15: code-table of figure E.1
- 0/14, 0/14: code-table of figure E.2
- 1/11, 6/14: code-table of figure E.3

These characters do not occupy a space in the display, but have effect on the displayable characters having the same address, and on all characters having numerically higher addresses up to, but not including, the address of another repertoire control character. In default of a repertoire control character, the display coding taking effect at address 0 should be assumed to be in accordance with figure E.1. Hex 0/A (line feed) and 0/D (carriage return) are used as control characters for Radiotext (see 3.1.5.3).

¹⁾ Including the figures 0 to 9 and punctuation; nonetheless, in certain cases, codes have been re-allocated to characters taken from the EBU repertoires, in accordance with the provision of ISO Publication 646.

²⁾ The notation A/B is used to designate the character appearing on line B of column A in the table.

For example, the name of the second Greek program service could be transmitted in type 0 groups as follows:

Characters: ΔE YT EP O
 Text segment address : 0 1 2 3

Text segment address	Character codes	Characters	Effect
0	0/14, 0/14	SO, SO	Selection of code-table (figure E.2)
0	15/14, 4/5	Δ, E	First two letters
1	5/9, 5/4	Y, T	Second two letters
2	4/5, 5/0	E, P	Third two letters
3	4/15, 2/0	O,	Last letter and space

					Additional displayable characters for:														
Displayable characters from the code table of ISO Norm 646:					EBU common-core (7 languages)							Complete Latin-based repertoire (25 languages)							
b3	b2	b1	b0		2	3	4	5	6	7	8	9	10	11	12	13	14	15	
0	0	0	0	0	0	@	P		p	á	â	ã	ä	å	Á	Â	Ã	Ä	
0	0	0	1	1	!	A	Q	a	q	ä	å	α	'	À	Ä	Å	ä	å	
0	0	1	0	2	"	B	R	b	r	é	è	©	²	É	È	Æ	æ		
0	0	1	1	3	#	C	S	c	s	è	ë	%	³	È	Ë	œ	œ		
0	1	0	0	4	¤	D	T	d	t	í	î	ç	±	Í	Î	ÿ	ÿ		
0	1	0	1	5	%	E	U	e	u	ì	ÿ	ě	ı	Ì	ÿ	ı	ı		
0	1	1	0	6	&	F	V	f	v	ó	ô	ñ	ı	Ó	Ô	Õ	ö		
0	1	1	1	7	'	G	W	g	w	ò	ó	ó	ı	Ò	Ó	Ø	ø		
1	0	0	0	8	(H	X	h	x	ú	û	π	μ	Ú	Û	Þ	þ		
1	0	0	1	9)	I	Y	i	y	ù	ü	£	ı	Ù	Ü	ŷ	ÿ		
1	0	1	0	10	*	:	J	j	z	ñ	ñ	£	ı	Ñ	Ñ	Ř	ř	Ŕ	
1	0	1	1	11	+	;	K	[⁽¹⁾	k	} ⁽¹⁾	ç	ç	\$	°	Č	č	Ć	ć	
1	1	0	0	12	,	<	L	\	l		ş	ş	←	¼	Š	š	Ś	ś	
1	1	0	1	13	-	=	M] ⁽¹⁾	m	} ⁽¹⁾	ß	ş	↑	½	Ž	ž	Ž	ž	
1	1	1	0	14	.	>	N		n		ı	ı	→	¾	Đ	đ	ƒ	ƒ	
1	1	1	1	15	/	?	O		o		ıı	ıı	↓	š	š	ı	ı	ı	

Figure E.1: Code table for 218 displayable characters forming the complete EBU Latin-based repertoire. The characters shown in positions marked ⁽¹⁾ in the table are those of the "international reference version" of ISO Publication 646 that do not appear in the complete Latin-based repertoire given in Appendix 2 of EBU document Tech. 3232 (2nd edition, 1982).

Attention is drawn to the fact that low cost receivers may be able to display only the characters in Column 2 lines 0, 7, 12, 13, 14 and 15; Column 3 lines 0 to 9; Column 4 lines 1 to 15; Column 5 lines 0 to 10.

The code-tables of figures E.1, E.2 and E.3 have also been adopted for the "service identification system" defined in the specifications of the MAC/packet family of systems for satellite broadcasting in Europe (see [13] in annex Q).

				Latin (ISO Publication 646)							EBU common-core			Part of the EBU complete Latin-based repertoire		Cyrillic etc.		Greek	
b3	b2	b1	b0	2	3	4	5	6	7	8	9	10	11	12	13	14	15		
0	0	0	0	0		@	P		p	ā	â	ä	ë	€	ý	Π	π		
0	0	0	1	1	!	A	Q	a	q	ã	ä	í	'	Я	Ь	α	Ω		
0	0	1	0	2	"	B	R	b	r	é	ê	©	²	Б	д'	β	ρ		
0	0	1	1	3	#	C	S	c	s	è	ë	‰	³	Ч	Ш	ψ	σ		
0	1	0	0	4	Ø	D	T	d	t	í	î	ă	±	Д	И	δ	τ		
0	1	0	1	5	%	E	U	e	u	ì	ï	ě	î	Э	Ю	ε	ξ		
0	1	1	0	6	&	F	V	f	v	ó	ô	ñ	ñ	Ф	Щ	φ	Θ		
0	1	1	1	7	'	G	W	g	w	ò	ö	ó	ú	Г	Ь	γ	Γ		
1	0	0	0	8	(H	X	h	x	ú	û	é	é	Ъ	У	ι	υ		
1	0	0	1	9)	I	Y	i	y	ù	ü	€	ç	И	Й	ι	υ		
1	0	1	0	10	*	:	J	Z	j	z	ñ	ñ	£	÷	Ж	З	Σ	ζ	
1	0	1	1	11	+	;	K	[⁽¹⁾	k	{ ⁽¹⁾	ç	ç	¢	°	К	č	x	ς	
1	1	0	0	12	,	<	L	\	l		ş	ş	←	¼	Л	š	λ	Λ	
1	1	0	1	13	-	=	M] ⁽¹⁾	m	{ ⁽¹⁾	ß	ğ	↑	½	М	ž	μ	Ψ	
1	1	1	0	14	.	>	N	_____	n	_____	ı	ı	→	¾	Н	đ	ν	Δ	
1	1	1	1	15	/	?	O	_____	o	_____	ıı	ıı	↓	§	Ы	ć	ω		

Figure E.2: Code table for a combined repertoire consisting of the EBU Common-core, Greek and upper-case Cyrillic alphabets (together with certain characters from the EBU complete Latin based repertoire, and the lower-case characters required for texts in Serbo-Croat, Slovenian, Slovakian, Hungarian and Romanian). The characters shown in positions marked ⁽¹⁾ in the table are those of the "international reference version" of ISO Publication 646 that do not appear in the "complete Latin-based repertoire" given in Appendix 2 of EBU document Tech. 3232 (2nd edition, 1982) [12].

				Latin (ISO Publication 646)			Arabic		Hebrew	Cyrillic etc.		Greek							
b7	b6	b5	b4	0	1	2	3	4	5	6	7	8	9	10	11	12	13	14	15
0	0	0	0	0	0	0	0	0	0	0	0	1	1	1	1	1	1	1	1
0	0	0	1	0	1	1	1	1	1	0	0	0	0	0	1	1	1	1	1
0	0	1	0	0	0	1	1	1	1	0	0	1	1	0	0	0	1	1	1
0	1	0	0	0	1	0	1	0	1	0	1	0	1	0	1	0	1	0	1
b3	b2	b1	b0	2	3	4	5	6	7	8	9	10	11	12	13	14	15		
0	0	0	0	0	0	@	P		p	ﺏ	ﻅ	כ	ל	Є	ý	Π	π		
0	0	0	1	1	!	A	Q	a	q	ﺏ	ﻉ	ג	ם	Я	Љ	α	Ω		
0	0	1	0	2	"	B	R	b	r	ﺏ	ﻉ	ג	ע	Б	д'	β	ρ		
0	0	1	1	3	#	C	S	c	s	ﺏ	ﻑ	ג	ע	Ч	Ш	ψ	σ		
0	1	0	0	4	Œ	D	T	d	t	ﺏ	ﻕ	ה	ה	Д	Ц	δ	τ		
0	1	0	1	5	%	E	U	e	u	ﺏ	ﻙ	ו	ז	Э	Ю	ε	ξ		
0	1	1	0	6	&	F	V	f	v	ﺏ	ﻝ	ז	ז	Ф	Щ	φ	θ		
0	1	1	1	7	'	G	W	g	w	ﺏ	ם	ח	פ	Г	Нь	γ	Γ		
1	0	0	0	8	(H	X	h	x	ﺏ	ﻥ	ט	ט	Б	Ц	η	Ξ		
1	0	0	1	9)	I	Y	i	y	ﺏ	ﻥ	ט	ט	И	Й	ι	υ		
1	0	1	0	10	*	J	Z	j	z	ﺏ	ﻥ	ט	ט	Ж	З	Σ	ζ		
1	0	1	1	11	+	;	K	[⁽¹⁾	k	} ⁽¹⁾	ﻉ	ﻉ	ל	°	К	č	x	ς	
1	1	0	0	12	,	<	L	\	l		ﺏ	←	ﻉ	¼	Л	š	λ	Λ	
1	1	0	1	13	-	=	M] ⁽¹⁾	m	} ⁽¹⁾	ﺏ	↑	ﻉ	½	М	ž	μ	Ψ	
1	1	1	0	14	.	>	N	_____	n	_____	ﺏ	→	ﻉ	¾	Н	đ	ν	Δ	
1	1	1	1	15	/	?	O	_____	o		ﺏ	↓	ﻉ	§	Ы	é	ω		

Figure E.3: Code table for a combined repertoire consisting of the ISO Publication 646 Latin-based alphabet, Greek, upper-case Cyrillic and Hebrew and Arabic. The characters shown in positions marked ⁽¹⁾ in the table are those of the "international reference version" of ISO Publication 646 that do not appear in the "complete Latin-based repertoire" given in Appendix 2 of EBU document Tech. 3232 (2nd edition, 1982) [12].

ANNEX F (normative)
Program Type codes
(North America)

Table F.1

Number	Code	Program type	8-Character Display ¹	16-Character Display ¹
0	0	No program type or undefined	None	None
1	1	News	News	News
2	10	Information	Inform	Information
3	11	Sports	Sports	Sports
4	100	Talk	Talk	Talk
5	101	Rock	Rock	Rock
6	110	Classic Rock	Cls_Rock	Classic_Rock
7	111	Adult Hits	Adlt_Hit	Adult_Hits
8	1000	Soft Rock	Soft_Rck	Soft_Rock
9	1001	Top 40	Top_40	Top_40
10	1010	Country	Country	Country
11	1011	Oldies	Oldies	Oldies
12	1100	Soft	Soft	Soft
13	1101	Nostalgia	Nostalga	Nostalgia
14	1110	Jazz	Jazz	Jazz
15	1111	Classical	Classicl	Classical

Table F.1 is continued overleaf

¹ These terms are recommended for 8-character and 16-character radio displays, respectively.

Table F.1 (continued from previous page)

Number	Code	Program type	8-Character Display ¹	16-Character Display ¹
16	10000	Rhythm and Blues	R_&_B	Rhythm_and_Blues
17	10001	Soft Rhythm and Blues	Soft_R&B	Soft_R_&_B
18	10010	Foreign Language	Language	Foreign_Language
19	10011	Religious Music	Rel_Musc	Religious_Music
20	10100	Religious Talk	Rel_Talk	Religious_Talk
21	10101	Personality	Persnlty	Personality
22	10110	Public	Public	Public
23	10111	College	College	College
24-28	11000-11100	Unassigned		
29	11101	Weather	Weather	Weather
30	11110	Emergency Test	Test	Emergency_Test
31	11111	Emergency	ALERT !	ALERT!_ALERT!

¹ These terms are recommended for 8-character and 16-character radio displays, respectively.

Definition of the terms used to denote Program Type

1	News	News reports, either local or network in origin.
2	Information	Programming that is intended to impart advice.
3	Sports	Sports reporting, commentary, and/or live event coverage, either local or network in origin.
4	Talk	Call-in and/or interview talk shows either local or national in origin.
5	Rock	Album cuts.
6	Classic Rock	Rock oriented oldies, often mixed with hit oldies, from a decade or more ago.
7	Adult Hits	An up-tempo contemporary hits format with no hard rock and no rap.
8	Soft Rock	Album cuts with a generally soft tempo.
9	Top 40	Current hits, often encompassing a variety of rock styles.
10	Country	Country music, including contemporary and traditional styles.
11	Oldies	Popular music, usually rock, with 80% or greater non-current music.
12	Soft	A cross between adult hits and classical, primarily non-current soft-rock originals.
13	Nostalgia	Big-band music.
14	Jazz	Mostly instrumental, includes both traditional jazz and more modern "smooth jazz."
15	Classical	Mostly instrumentals, usually orchestral or symphonic music.
16	Rhythm and Blues	A wide range of musical styles, often called "urban contemporary."
17	Soft Rhythm and Blues	Rhythm and blues with a generally soft tempo.
18	Foreign Language	Any programming format in a language other than English.

19	Religious Music	Music programming with religious lyrics.
20	Religious Talk	Call-in shows, interview programs, etc. with a religious theme.
21	Personality	A radio show where the on-air personality is the main attraction.
22	Public	Programming that is supported by listeners and/or corporate sponsors instead of advertising.
23	College	Programming produced by a college or university radio station.
24-28	Unassigned	
29	Weather	Weather forecasts or bulletins that are non-emergency in nature.
30	Emergency Test	Broadcast when testing emergency broadcast equipment or receivers. Not intended for searching or dynamic switching for consumer receivers.. Receivers may, if desired, display "TEST" or "Emergency Test".
31	Emergency	Emergency announcement made under exceptional circumstances to give warning of events causing danger of a general nature. Not to be used for searching - only used in a receiver for dynamic switching.

Note: These definitions can differ slightly between various language versions.

Program Type codes
(Europe)

Table F.2

Number	Code	Program Type	8-character display ¹	16-character display ¹)
0	00000	No program Type or undefined	None	None
1	00001	News	News	News
2	00010	Current Affairs	Affairs	Current Affairs
3	00011	Information	Info	Information
4	00100	Sport	Sport	Sport
5	00101	Education	Educate	Education
6	00110	Drama	Drama	Drama
7	00111	Culture	Culture	Cultures
8	01000	Science	Science	Science
9	01001	Varied	Varied	Varied Speech
10	01010	Pop Music	Pop M	Pop Music
11	01011	Rock Music	Rock M	Rock Music
12	01100	Easy Listening Music ²⁾	Easy M	Easy Listening
13	01101	Light classical	Light M	Light Classics M
14	01110	Serious classical	Classics	Serious Classics
15	01111	Other Music	Other M	Other Music

Table F.2 is continued overleaf

¹) These short terms are recommended for the eight character and sixteen character display of the radio in English. Other language versions are available from the EBU and the RDS Forum on the Internet World Wide Web site at URL: <http://www.rds.org.uk/>.

²) In earlier versions of this standard, the term used was "M.O.R. Music". Easy Listening is a more frequently used equivalent.

Number	Code	Program type	8-character display ¹	16-character display ¹
16	10000	Weather	Weather	Weather & Metr
17	10001	Finance	Finance	Finance
18	10010	Children's programs	Children	Children's Progs
19	10011	Social Affairs	Social	Social Affairs
20	10100	Religion	Religion	Religion
21	10101	Phone In	Phone In	Phone In
22	10110	Travel	Travel	Travel & Touring
23	10111	Leisure	Leisure	Leisure & Hobby
24	11000	Jazz Music	Jazz	Jazz Music
25	11001	Country Music	Country	Country Music
26	11010	National Music	Nation M	National Music
27	11011	Oldies Music	Oldies	Oldies Music
28	11100	Folk Music	Folk M	Folk Music
29	11101	Documentary	Document	Documentary
30	11110	Alarm Test	TEST	Alarm Test
31	11111	Alarm	Alarm !	Alarm - Alarm !

¹ These short terms are recommended for the eight character and sixteen character display of the radio in English. Other language versions are available from the EBU and the RDS Forum on the Internet World Wide Web site at URL: <http://www.rds.org.uk/>.

Definition of the terms used to denote Program Type

1	News	Short accounts of facts, events and publicly expressed views, reportage and actuality.
2	Current affairs	Topical program expanding or enlarging upon the news, generally in different presentation style or concept, including debate, or analysis.
3	Information	Program the purpose of which is to impart advice in the widest sense.
4	Sport	Program concerned with any aspect of sport.
5	Education	Program intended primarily to educate, of which the formal element is fundamental.
6	Drama	All radio plays and serials.
7	Culture	Programs concerned with any aspect of national or regional culture, including language, theater, etc.
8	Science	Programs about the natural sciences and technology.
9	Varied	Used for mainly speech-based programs usually of light-entertainment nature, not covered by other categories. Examples include: quizzes, panel games, personality interviews.
10	Pop	Commercial music, which would generally be considered to be of current popular appeal, often featuring in current or recent record sales charts.
11	Rock	Contemporary modern music, usually written and performed by young musicians.
12	Easy Listening ²⁾	Current contemporary music considered to be "easy-listening", as opposed to Pop, Rock or Classical, or one of the specialized music styles, Jazz, Folk or Country. Music in this category is often but not always, vocal, and usually of short duration.
13	Light classics	Classical Musical for general, rather than specialist appreciation. Examples of music in this category are instrumental music, and vocal or choral works.
14	Serious classics	Performances of major orchestral works, symphonies, chamber music etc., and including Grand Opera.
15	Other music	Musical styles not fitting into any of the other categories. Particularly used for specialist music of which Rhythm & Blues and Reggae are examples.
16	Weather	Weather reports and forecasts and Meteorological information.

²⁾ In earlier versions of this standard, the term used was "M.O.R. Music". Easy Listening is a more frequently used equivalent.

17	Finance	Stock Market reports, commerce, trading etc.
----	----------------	--

18	Children's programs	For programs targeted at a young audience, primarily for entertainment and interest, rather than where the objective is to educate.
19	Social Affairs	Programs about people and things that influence them individually or in groups. Includes: sociology, history, geography, psychology and society.
20	Religion	Any aspect of beliefs and faiths, involving a God or Gods, the nature of existence and ethics.
21	Phone In	Involving members of the public expressing their views either by phone or at a public forum.
22	Travel	Features and programs concerned with travel to near and far destinations, package tours and travel ideas and opportunities. Not for use for <i>Announcements about problems, delays, or roadworks affecting immediate travel where TP/TA should be used.</i>
23	Leisure	Programs concerned with recreational activities in which the listener might participate. Examples include, Gardening, Fishing, Antique collecting, Cooking, Food & Wine etc.
24	Jazz Music	Polyphonic, syncopated music characterized by improvisation.
25	Country Music	Songs which originate from, or continue the musical tradition of the American Southern States. Characterized by a straightforward melody and narrative story line.
26	National Music	Current Popular Music of the Nation or Region in that country's language, as opposed to International 'Pop' which is usually US or UK inspired and in English.
27	Oldies Music	Music from the so-called "golden age" of popular music.
28	Folk Music	Music which has its roots in the musical culture of a particular nation, usually played on acoustic instruments. The narrative or story may be based on historical events or people.
29	Documentary	Program concerned with factual matters, presented in an investigative style.
30	Alarm Test	Broadcast when testing emergency broadcast equipment or receivers. Not intended for searching or dynamic switching for consumer receivers.. Receivers may, if desired, display "TEST" or "Alarm Test".
31	Alarm	Emergency announcement made under exceptional circumstances to give warning of events causing danger of a general nature. Not to be used for searching - only used in a receiver for dynamic switching.

Note: These definitions can slightly differ between various language versions.

ANNEX G (informative)

Conversion between time and date conventions

The types of conversion which may be required are summarized in the diagram below.

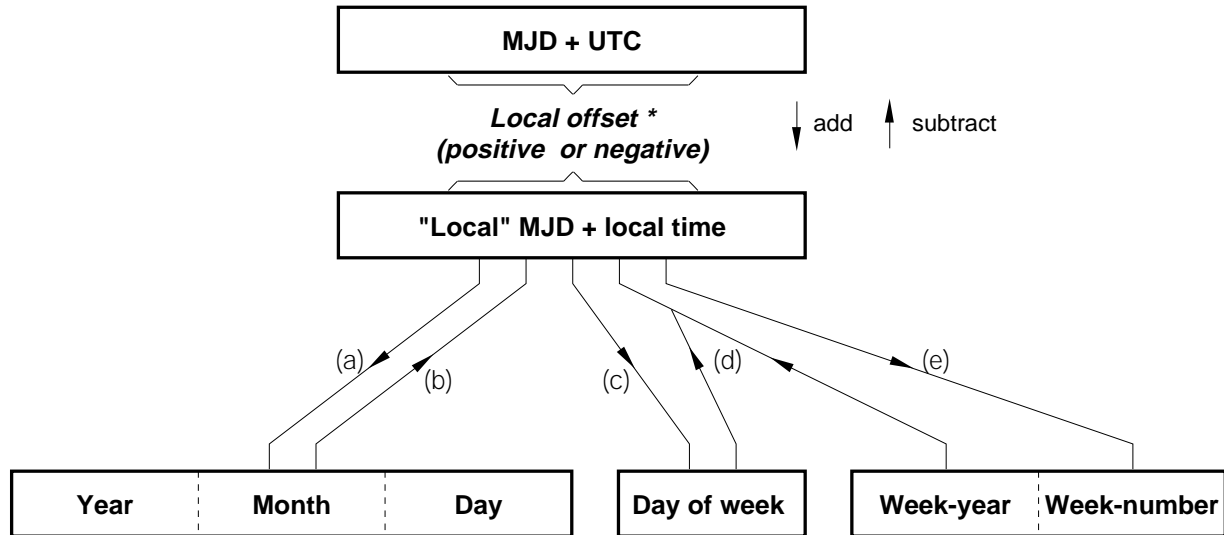

* Offsets are positive for longitudes east of Greenwich and negative for longitudes west of Greenwich.

Figure G.1: Conversion routes between Modified Julian Date (MJD) and Coordinated Universal Time (UTC)

The conversion between MJD + UTC and the "local" MJD + local time is simply a matter of adding or subtracting the local offset. This process may, of course, involve a "carry" or "borrow" from the UTC affecting the MJD. The other five conversion routes shown on the diagram are detailed in the formulas below.

Table G.1: Symbols used

MJD	Modified Julian Day
UTC	Coordinated Universal Time
Y	Year from 1900 (e.g. for 2003, Y = 103)
M	Month from January (= 1) to December (= 12)
D	Day of month from 1 to 31
WY	"Week number" Year from 1900
WN	Week number according to ISO 2015
WD	Day of week from Monday (= 1) to Sunday (= 7)
K, L, M', W, Y'	Intermediate variables
x	Multiplication
int	Integer part, ignoring remainder
mod 7	Remainder (0-6) after dividing integer by 7

a) To find Y, M, D from MJD

$$Y' = \text{int} [(\text{MJD} - 15\,078,2) / 365,25]$$
$$M' = \text{int} \{ [\text{MJD} - 14\,956,1 - \text{int} (Y' \times 365,25)] / 30,6001 \}$$
$$D = \text{MJD} - 14\,956 - \text{int} (Y' \times 365,25) - \text{int} (M' \times 30,6001)$$

If $M' = 14$ or $M' = 15$, then $K = 1$; else $K = 0$

$$Y = Y' + K$$
$$M = M' - 1 - K \times 12$$

b) **To find MJD from Y, M, D**

If $M = 1$ or $M = 2$, then $L = 1$; else $L = 0$

$$\text{MJD} = 14\,956 + D + \text{int} [(Y - L) \times 365,25] + \text{int} [(M + 1 + L \times 12) \times 30,6001]$$

c) **To find WD from MJD**

$$\text{WD} = [(\text{MJD} + 2) \bmod 7] + 1$$

d) **To find MJD from WY, WN, WD**

$$\text{MJD} = 15\,012 + \text{WD} + 7 \times \{ \text{WN} + \text{int} [(\text{WY} \times 1\,461 / 28) + 0,41] \}$$

e) **To find WY, WN from MJD**

$$W = \text{int} [(\text{MJD} / 7) - 2\,144,64]$$
$$\text{WY} = \text{int} [(W \times 28 / 1\,461) - 0,0079]$$
$$\text{WN} = W - \text{int} [(\text{WY} \times 1\,461 / 28) + 0,41]$$

Example:

MJD = 45 218	W = 4 315
Y = (19)82	WY = (19)82
M = 9 (September)	WN = 36
D = 6	WD = 1 (Monday)

Note: These formulas are applicable between the inclusive dates: 1st March 1900 to 28th February 2100.

ANNEX H (informative)

Specification of the ARI System

H.1 Frequency of the subcarrier

H.1.1 Nominal value: 57 kHz

H.1.2 Tolerances:

Mono: ± 6 Hz

Stereo: The phase relationship between the pilot tone and the subcarrier is such that when both sine waves are crossing the time axis simultaneously, the slopes have to be the same. Since the tolerance of the pilot tone can be ± 2 Hz, the frequency of the subcarrier can deviate by ± 6 Hz.

H.2 Frequency deviation

± 3.5 kHz, if used simultaneously with RDS on the same transmitter

H.3 Modulation

AM

H.4 Traffic announcement identification

H.4.1 Modulation frequency: 125 Hz (57 kHz divided by 456)

H.4.2 Tolerance: derived from 57 kHz subcarrier

H.4.3 Modulation depth: $m = 30\%$

H.5 Traffic area identification

H.5.1 Modulation frequencies: derived from the subcarrier frequency

Table H.1

Traffic area	Frequency (Hz)	Frequency division ratio
A	23.7500	2400
B	28.2738	2016
C	34.9265	1632
D	39.5833	1440
E	45.6731	1248
F	53.9773	1056

H.5.2 Modulation depth: $m = 60\%$

ANNEX J (normative)

Language identification

To enable a broadcaster to indicate the spoken language he is currently transmitting, the 8 bit language identification codes in Table J.1¹ shall be used.

In Group 1A, Variant 3, Block 3 the Language identification code is allocated according to figure J.1. When implemented, this variant should be transmitted at least once every two seconds.

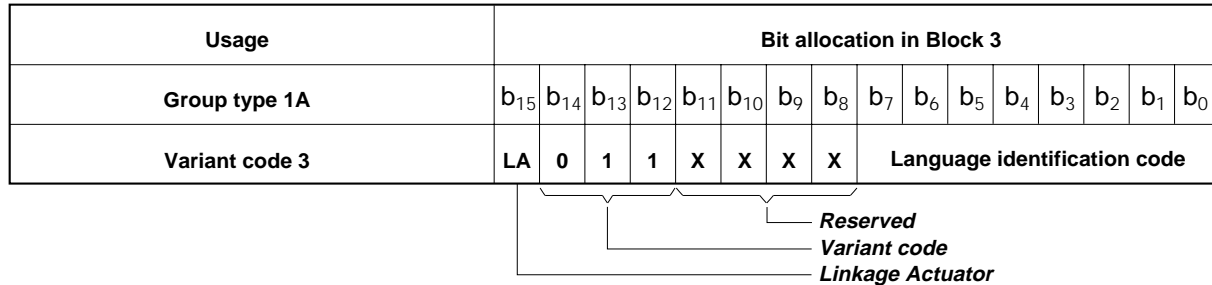

Figure J.1

Table J.1

a) European languages written in Latin-based alphabets:

<u>Code</u> (Hexadecimal)	<u>Language</u>	<u>Code</u> (Hexadecimal)	<u>Language</u>
00	Unknown/not applicable	20	Polish
01	Albanian	21	Portuguese
02	Breton	22	Romanian
03	Catalan	23	Romansh
04	Croatian	24	Serbian
05	Welsh	25	Slovak
06	Czech	26	Slovene
07	Danish	27	Finnish
08	German	28	Swedish
09	English	29	Turkish
0A	Spanish	2A	Flemish
0B	Esperanto	2B	Walloon
0C	Estonian	2C	
0D	Basque	2D	
0E	Faroese	2E	
0F	French	2F	
10	Frisian	30)
11	Irish	31)
12	Gaelic	32)_ Reserved for
13	Galician	33) national assignment
14	Icelandic	34)
15	Italian	35)

¹This Table is in accordance with ETS 300 250: "Specification of the D2-MAC/packet system" EBU/ETSI-JTC European Telecommunication Standard, 1993.

<u>Code</u> (Hexadecimal)	<u>Language</u>	<u>Code</u> (Hexadecimal)	<u>Language</u>
16	Lappish	36)
17	Latin	37)
18	Latvian	38)
19	Luxembourgian	39)
1A	Lithuanian	3A) _ Reserved for
1B	Hungarian	3B) national assignment
1C	Maltese	3C)
1D	Dutch	3D)
1E	Norwegian	3E)
1F	Occitan	3F)

b) Other languages:

<u>Code</u> (Hexadecimal)	<u>Language</u>	<u>Code</u> (Hexadecimal)	<u>Language</u>
7F	Amharic	5F	Marathi
7E	Arabic	5E	Ndebele
7D	Armenian	5D	Nepali
7C	Assamese	5C	Oriya
7B	Azerbaijan	5B	Papamiento
7A	Bambora	5A	Persian
79	Belorussian	59	Punjabi
78	Bengali	58	Pushtu
77	Bulgarian	57	Quechua
76	Burmese	56	Russian
75	Chinese	55	Ruthenian
74	Churash	54	Serbo-Croat
73	Dari	53	Shona
72	Fulani	52	Sinhalese
71	Georgian	51	Somali
70	Greek	50	Sranan Tongo
6F	Gujurati	4F	Swahili
6E	Gurani	4E	Tadzhik
6D	Hausa	4D	Tamil
6C	Hebrew	4C	Tatar
6B	Hindi	4B	Telugu
6A	Indonesian	4A	Thai
69	Japanese	49	Ukrainian
68	Kannada	48	Urdu
67	Kazakh	47	Uzbek
66	Khmer	46	Vietnamese
65	Korean	45	Zulu
64	Laotian	44	
63	Macedonian	43	
62	Malagasay	42	
61	Malaysian	41	
60	Moldavian	40	Background sound/ Clean feed

ANNEX K (informative)

RDS logo¹

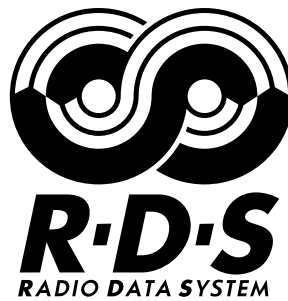

Note: The wording "RADIO DATA SYSTEM" may be omitted.

When EON is implemented, the following logos may be used:



¹© European Broadcasting Union and British Broadcasting Corporation 1992 and 1996

® Trademark National Association of Broadcasters (U.S. only). Trademark registered on behalf of the National Radio Systems Committee.

ANNEX L (informative)

Open data registration

L.1 (USA)

Every data application using the Open Data Applications (ODA) feature (see 3.1.4) must be transmitted together with an Application Identification (AID) number (see 3.1.5.4). The AID number, for each ODA *in the United States*, is allocated by the RDS Registrations Office at the address shown in the following Registration Form. Forms must be completed fully (every question must be answered - the RDS Registrations Office will advise, if difficulty is experienced) and sent to the RDS Registrations Office, together with the nominal fee of US \$495 (make check payable to "National Association of Broadcasters"), which is payable in advance. Subject to satisfactory completion, an AID number will be allocated and a copy of the Form will be returned to the applicant.

Transmissions carrying an AID *must* adhere fully to the details, specifications and references of the relevant registration. (Any subsequent updates, that do not *change* the fundamental requirements for the transmission of that ODA, may allow continued use of the same AID, but advice should be sought from the RDS Registrations Office.)

Details will be kept in the EBU/RDS Forum ODA Directory, which will be published, from time to time, and an up-to-date version of the Directory will be maintained on the RDS Forum Web site at URL: <http://www.rds.org.uk/>.

Users of an AID must satisfy themselves as to the validity of using it and the accuracy of all related information and must accept all due consequence. The RDS Registrations Office is not liable for any incidental, special or consequential damages arising out of the use or inability to use an AID, whether in transmission or reception equipment.

Note: AID codes are Internationally allocated and recognized. Application forms for the U.S. and Europe are included for payment convenience only.

Form overleaf...

RDS Open Data Applications - Registration Form <i>This Form will be published in full, except last two answers, if specifically not permitted.</i>
--

To:	RDS Registrations Office NAB Science and Technology Department 1771 N Street, NW Washington, DC 20036-2891 USA	Application Date:
-----	--	-------------------

<i>Question</i>	<i>Information</i>	<i>Comment</i>
Applicants Name:		Title/Name of contact
Organisation:		Company Name
Organisation Address:		Street 1
		Street 2
		Town/City
		Area/County
		Postal Code
		Country
Application Name:		5 or 6 words, maximum
Application Description:	<i>Please use additional pages if desired.</i>	Give as much detail as possible.
Open Data mode: (see 3.1.5.4)		Choose one mode, only
ODA details, specifications and references:	Tick, if publication not permitted [<input type="checkbox"/>] <i>Please attach additional pages.</i>	Give <i>all</i> details, proprietary documents and references.
Capacity requirement for both the ODA and AID groups:	Tick, if publication not permitted [<input type="checkbox"/>] a) ODA groups/second b) type 3A groups/minute <i>Please use additional pages if desired.</i>	Indicate: ODA groups/second <i>and</i> type 3A groups/minute. Describe any constraints.

Applicant represents and warrants that it is the owner of all rights in and to the application described herein, and that the application does not infringe any rights, whether common law, statutory, legal or equitable, of any third party.

Neither NAB, CEMA, EIA nor the NRSC shall be liable for disclosure of Confidential Information if made in response to an order of a court or authorized agency of government; provided that when possible notice shall first be given to the applicant/registrant so that a protective order, if desired, may be sought by that party.

Applicant hereby agrees to defend, indemnify and hold NAB, CEMA, EIA, the NRSC and the officers, directors, employees, agents and assigns of any of them (hereinafter "the indemnified parties") harmless against any and all claims, liabilities, judgments, penalties, and taxes, civil and criminal, and all costs and expenses, including reasonable attorneys' fees, which may arise out of or are related to Applicant's representations, warranties, application and/or registration thereof or the actions or failure to act of the indemnified parties with regard to same.

The application/registration system in the United States shall be governed in accordance with the substantive law of the District of Columbia.

Applicant Signature

Date

L.2 (USA)

Data application designers need to consider a number of questions regarding their application and the RDS system interface, so that the RDS bearer is kept in conformity with best implementation practice. The following questions should be carefully considered (the RDS Registrations Office will advise, if difficulty is experienced) and the following Check List must be completed and attached to all applications.

<p>RDS Open Data Applications - Check List</p> <p><i>This Check List will not be published.</i></p>
--

<i>Question</i>	<i>Considered</i>	<i>Notes</i>
Does the application behave correctly when not all RDS groups are received?	Tick, if considered [<input type="checkbox"/>]	Necessary for mobile RDS applications
Does the application provide the means to identify the Service Provider?	Tick, if considered [<input type="checkbox"/>]	
Does the application allow for future proofing, by upgrading?	Tick, if considered [<input type="checkbox"/>]	
Does the application require sub-sets of associated applications?	Tick, if considered [<input type="checkbox"/>]	Use of variant codes and/or other groups (e.g. clock-time)
Does the application include provision to reference other transmissions carrying the same service?	Tick, if considered [<input type="checkbox"/>]	PI and AF
Does the application include an additional layer of error protection?	Tick, if considered [<input type="checkbox"/>]	RDS already has considerable capability
Does the application include encryption?	Tick, if considered [<input type="checkbox"/>]	
Does the application include data compression?	Tick, if considered [<input type="checkbox"/>]	
Have you defined the capacity requirements for the application?	Tick, if considered [<input type="checkbox"/>]	
Have you defined the capacity requirements for the AID under normal conditions?	Tick, if considered [<input type="checkbox"/>]	
Is your application able to assume and lose the use of a group type?	Tick, if considered [<input type="checkbox"/>]	
If so, have you defined the AID signaling when use of a channel is assumed?	Tick, if considered [<input type="checkbox"/>]	
If so, have you defined the AID signaling when use of the channel ceases?	Tick, if considered [<input type="checkbox"/>]	

ANNEX L (informative)

Open data registration

L.3 (Europe)

Every data application using the Open Data Applications (ODA) feature (see 3.1.4) must be transmitted together with an Application Identification (AID) number (see 3.1.5.4). The AID number, for each ODA *outside the United States*, is allocated by the RDS Registrations Office at the address shown in the following Registration Form. Forms must be completed fully (every question must be answered - the RDS Registrations Office will advise, if difficulty is experienced) and sent to the RDS Registrations Office, together with the nominal fee of CHF 500, which is payable in advance. Subject to satisfactory completion, an AID number will be allocated and a copy of the Form will be returned to the applicant.

Transmissions carrying an AID *must* adhere fully to the details, specifications and references of the relevant registration. (Any subsequent updates, that do not *change* the fundamental requirements for the transmission of that ODA, may allow continued use of the same AID, but advice should be sought from the RDS Registrations Office.)

Details will be kept in the EBU/RDS Forum ODA Directory, which will be published, from time to time, and an up-to-date version of the Directory will be maintained on the RDS Forum Web site at URL: <http://www.rds.org.uk/>.

Users of an AID must satisfy themselves as to the validity of using it and the accuracy of all related information and must accept all due consequence. The RDS Registrations Office is not liable for any incidental, special or consequential damages arising out of the use or inability to use an AID, whether in transmission or reception equipment.

Form overleaf...

RDS Open Data Applications - Registration Form

This Form will be published in full, except last two answers, if specifically not permitted.

To:	RDS Registrations Office European Broadcasting Union / Union Européenne de Radio-Télévision Ancienne Route 17A Case postale 67 CH-1218 Grand Saconnex GE SWITZERLAND - SUISSE	Application Date:
-----	---	-------------------

<i>Question</i>	<i>Information</i>	<i>Comment</i>
Applicants Name:		Title/Name of contact
Organisation:		Company Name
Organisation Address:		Street 1
		Street 2
		Town/City
		Area/County
		Postal Code
		Country
Application Name:		5 or 6 words, maximum
Application Description:	<i>Please use additional pages if desired.</i>	Give as much detail as possible.
Open Data mode: (see 3.1.5.4)		Choose one mode, only
ODA details, specifications and references:	Tick, if publication not permitted [<input type="checkbox"/>] <i>Please attach additional pages.</i>	Give <i>all</i> details, proprietary documents and references.
Capacity requirement for both the ODA and AID groups:	Tick, if publication not permitted [<input type="checkbox"/>] a) ODA groups/second b) type 3A groups/minute <i>Please use additional pages if desired.</i>	Indicate: ODA groups/second <i>and</i> type 3A groups/minute. Describe any constraints.

L.4 (Europe)

Data application designers need to consider a number of questions regarding their application and the RDS system interface, so that the RDS bearer is kept in conformity with best implementation practice. The following questions should be carefully considered (the RDS Registrations Office will advise, if difficulty is experienced) and the following Check List must be completed and attached to all applications.

RDS Open Data Applications - Check List

This Check List will not be published.

<i>Question</i>	<i>Considered</i>	<i>Notes</i>
Does the application behave correctly when not all RDS groups are received?	Tick, if considered [<input type="checkbox"/>]	Necessary for mobile RDS applications
Does the application provide the means to identify the Service Provider?	Tick, if considered [<input type="checkbox"/>]	
Does the application allow for future proofing, by upgrading?	Tick, if considered [<input type="checkbox"/>]	
Does the application require sub-sets of associated applications?	Tick, if considered [<input type="checkbox"/>]	Use of variant codes and/or other groups (e.g. clock-time)
Does the application include provision to reference other transmissions carrying the same service?	Tick, if considered [<input type="checkbox"/>]	PI and AF
Does the application include an additional layer of error protection?	Tick, if considered [<input type="checkbox"/>]	RDS already has considerable capability
Does the application include encryption?	Tick, if considered [<input type="checkbox"/>]	
Does the application include data compression?	Tick, if considered [<input type="checkbox"/>]	
Have you defined the capacity requirements for the application?	Tick, if considered [<input type="checkbox"/>]	
Have you defined the capacity requirements for the AID under normal conditions?	Tick, if considered [<input type="checkbox"/>]	
Is your application able to assume and lose the use of a group type?	Tick, if considered [<input type="checkbox"/>]	
If so, have you defined the AID signaling when use of a channel is assumed?	Tick, if considered [<input type="checkbox"/>]	
If so, have you defined the AID signaling when use of the channel ceases?	Tick, if considered [<input type="checkbox"/>]	

ANNEX M (normative)

Coding of Radio Paging (RP)

M.1. Introduction

The following radio paging systems described in this annex:

- The Basic Paging Protocol.
- The Enhanced Paging Protocol.

While the basic protocol offers all the basic features necessary for a national service, the enhanced paging offers a great number of improvements such as:

- An easy-to-implement international service.
- Multi operator and/or multi area paging services.

More than these features, the enhanced paging offers a dramatically increased battery life time.

The message labeling has also been improved: a message call counter and a repetition flag have been added for a better reliability of the paging service.

The following abbreviations are used in this annex:

CCF	Current Carrier Frequency
OPC	Operator Code
PAC	Paging Area Code
SI	System Information
VAS	Value Added Services
CS	Cycle Selection
CT	Clock Time
ECC	Extended Country Code
EPP	Enhanced Paging Protocol
IT	Interval Numbering
NI	National International
PIN	Program Item Number
STY	Sub TYPE group

M.2 Basic paging protocol

M.2.1 Coding characteristics for paging

M.2.1.1 General

M.2.1.1.1 Group type 4A¹), clock-time and date (CT), is transmitted at the start of every minute.

¹) The transmitted CT (see 3.1.5.6 and 3.2.3) must be accurate, otherwise the CT codes must all be set to zero.

M.2.1.1.2 Group type 1A, program-item number (PIN), is transmitted at least once per second. The five last bits of its block 2 are used for radio paging codes as follows:

- bits B₄-B₂: 3-bit transmitter network group designation
- bits B₁-B₀: battery saving interval synchronization and identification.

M.2.1.1.3 Group type 7A is used to convey the paging information.

M.2.1.2 Transmitter network group designation

The first three bits of the five last bits of block 2 of Group type 1A (radio paging codes, as defined in M.2.1.1.2) are used to designate the transmitter network to a group of pager group codes. Pagers not belonging to the designated group codes must not lock to the transmitter.

The group designations are as follows:

Table M.1

B ₄	B ₃	B ₂	Group codes	Number of group codes
0	0	0	No basic paging on channel	
0	0	1	00-99	100
0	1	0	00-39	40
0	1	1	40-99	60
1	0	0	40-69	30
1	0	1	70-99	30
1	1	0	00-19	20
1	1	1	20-39	20

The transmitter network group designation makes it possible to distribute the paging calls over one to four networks, e.g. several networks during day-time and a single network during the night-time. The number of group codes in each network is shown below for the different number of networks in operation.

Number of transmitter networks	Number of group codes respectively
1	100
2	40/60
3	40/30/30
4	20/20/30/30

M.2.1.3 Transmission sequence (battery saving)

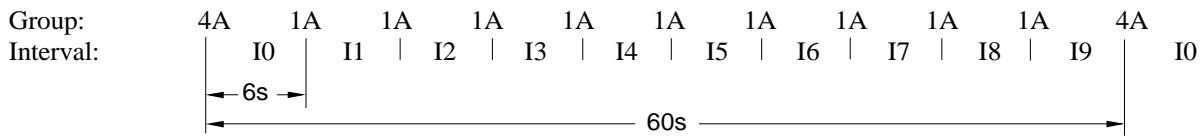

Timing within intervals:

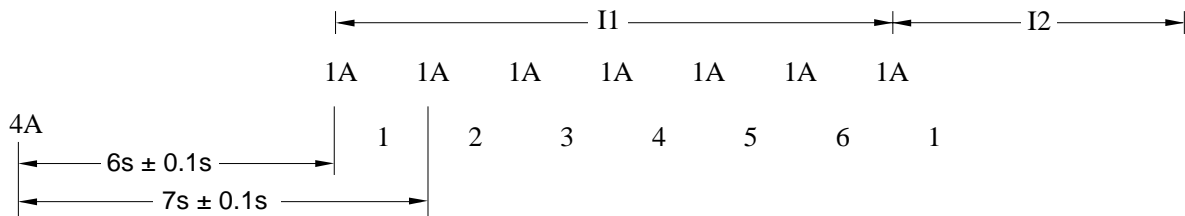

1A number within interval	1	2	3	4	5	6	1
Bit B ₁	1	1	0	0	0	0	1
Bit B ₀	0	J3	J2	J1	J0	1	0

For battery saving purposes, each minute is divided into ten intervals of equal length (I0 ... I9). Each paging receiver belongs to the interval corresponding to the last digit of its individual code (digit 0 belongs to I0 and so on). Paging calls are placed within the interval corresponding to the last digit or within the two intervals following that interval.

To enable the receivers to synchronize to the correct interval, the last two bits, B₁ and B₀, of the five last bits of block 2 of Group type 1A are used. The start of an interval is indicated by the transmission of two 1A groups with B₁ = 1 (in interval I0 the first 1A group is replaced by 4A). The first 1A (or 4A for I0) group is transmitted at the start interval and the other one second later. Within an interval at least three more 1A groups are transmitted (bit B₁ = 0). Bit B₀ of 1A groups number 2, 3, 4 and 5 is used to sequentially transmit the four bits J3, J2, J1, J0 of the BCD-coded interval number 0 ... 9. Excessive 1A groups within an interval have their bit B₀ = 1.

For the paging receiver, one minute is the interval between two consecutive 4A groups. This minute contains either 685 or 686 RDS groups. For the paging receiver, one second is the interval between two consecutive 1A groups. This second contains 11 or 12 RDS groups. Consequently, for a paging receiver, the duration of the relevant time intervals is equal to one second or one minute plus or minus the length of one RDS group.

The receiver may enter battery saving mode after start of its interval:

- if at least 10 groups differing from group type 7A have been received;
- if a paging call, belonging to an interval different from the receivers' own and the two preceding intervals, has been received;
- after the start of the third interval after its own interval.

The receiver shall be considered to have lost its interval synchronization:

- if there is a paging call within the receivers' own interval to a receiver not belonging to the interval or the two preceding intervals, or
- if an error-free reception of the interval marking (J3, J2, J1, J0) is not the one expected.

Checking of J3, J2, J1, J0 is not necessary each time the receiver leaves battery saving mode.

M.2.1.4 Locking to a channel

M.2.1.4.1 The receiver searches for one of the offset words A ... D. When this is found, it searches for the next expected offset word at a distance of: n times 26 bits, $n = 1 \dots 6$. When two offset words have been found, the receiver is synchronized to both block and group. After block and group synchronization, the receiver must find the correct country code (within the PI-code) and group designation of the transmitter network.

M.2.1.4.2 When scanning the frequency band, block and group synchronization must occur within 1 sec. and correct country code and group designation must be found within 2 sec. after block and group synchronization. Otherwise the receiver must leave the channel.

M.2.1.4.3 When locking to the channel after battery saving mode, block and group synchronization and the reception of correct country code and transmitter group designation must occur within 15 sec. Otherwise the receiver shall leave the channel.

M.2.1.4.4 For quick scanning, the information about alternative frequencies in group type 0A may be used.

M.2.1.5 Loss of synchronization

M.2.1.5.1 Clockslip may be detected by using the fact that the program identification (PI) code is rarely altered. By calculating the syndrome for this block and the block shifted plus/minus one bit, it is possible to see whether clockslip has occurred. If the information becomes correct after a one bit shift, it is considered that a clockslip has occurred, all received data is shifted accordingly and the receiver is correctly synchronized.

M.2.1.5.2 When 43 out of the last received 45 blocks have a syndrome different from zero (for the respective offset words), the channel locking is lost and the receiver shall scan the band for a better channel.

M.2.1.5.3 If the group code of the receiver is no longer in accordance with the transmitter group designation code, the receiver shall leave the channel and scan the band for a new channel.

M.2.1.6 Group type 7A message format

M.2.1.6.1 General

Group type 7A:

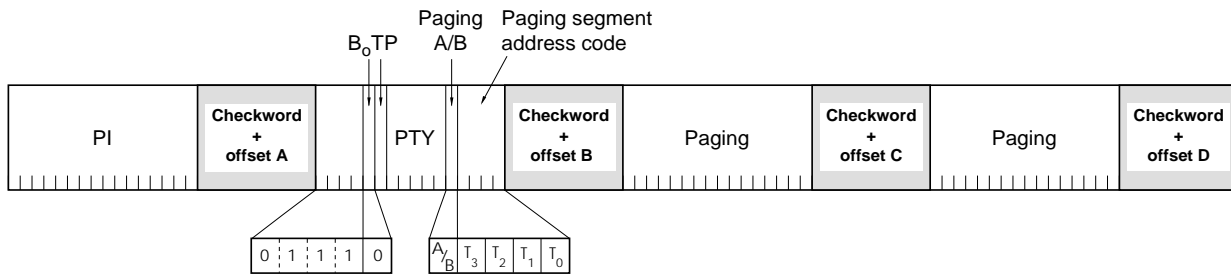

Figure M.1: Group type 7A message format for Radio Paging

Block 1 comprises the PI code found as the first block of every RDS group type. Blocks 3 and 4 are used for paging information.

In block 2 the five last bits are used to control the paging information. Bit AB, paging A/B, is used as a flag which changes its value between different paging calls thus indicating the start of a new or repeated call. Bits T₃-T₀ are used as a 4-bit paging segment address code and to indicate the type of additional message that follows:

Table M.2

T ₃	T ₂	T ₁	T ₀	Message contents:
0	0	0	0	No additional message
0	0	0	1	Part of functions message
0	0	1	X	10 digit numeric message or part of functions message
0	1	X	X	18 digit numeric message or 15 digit numeric message in international paging
1	X	X	X	Alphanumeric message
X indicates state 0 or 1				

M.2.1.6.2 Paging without additional message

Group type 7A:

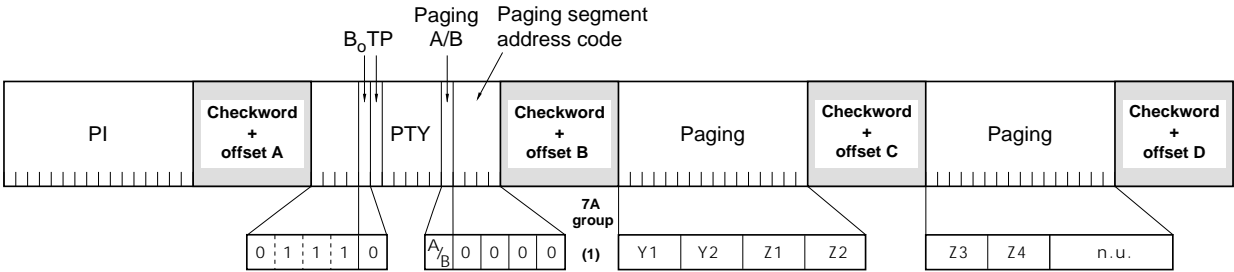

Figure M.2: Group type 7A paging without additional message

- Y1Y2 denotes the group code
- Z1...Z4 denotes the individual code within the group
- Yn and Zn denote BCD-coded digits 0 ... 9
- n.u. 8 last bits of block 4 not used.

The paging segment address code, used to indicate the contents of blocks 3 and 4, is set to 0000.

M.2.1.6.3 Paging with additional numeric message

The additional numeric message is transmitted in one or two 7A groups following the first 7A group of the call. Other group types may be transmitted in between:

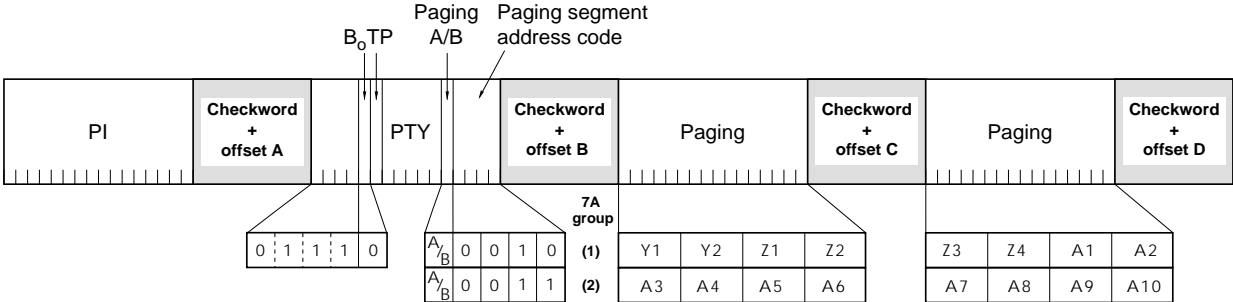
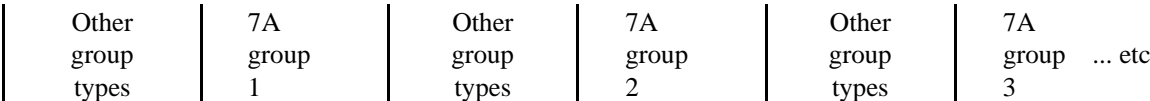

Figure M.3: Group type 7A paging with additional 10 digit message

Third 7A group only transmitted in case of an 18 digit message.

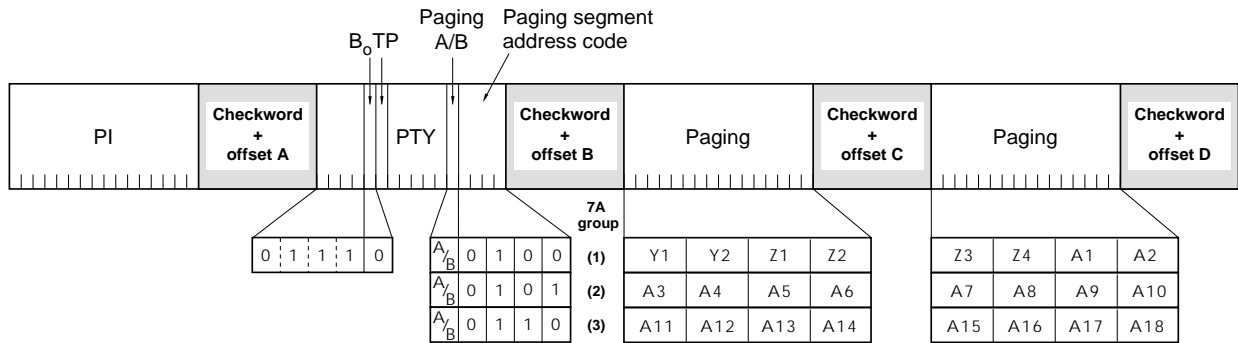

Figure M.4: Group type 7A paging with additional 18 digit message

The paging segment address code is used to indicate the contents of blocks 3 and 4 in respective groups:

Table M.3

T ₃	T ₂	T ₁	T ₀	Contents of blocks 3 and 4
				10 digit message:
0	0	1	0	Group and individual code Y1Y2 Z1...Z4 plus message digits A1...A2
0	0	1	1	Message digits A3...A10
				18 digit message:
0	1	0	0	Group and individual code Y1Y2 Z1...Z4 plus message digits A1...A2
0	1	0	1	Message digits A3...A10
0	1	1	0	Message digits A11...A18

Y1Y2 denotes the group code
 Z1...Z4 denotes the individual code within the group
 Y_n and Z_n denote BCD-coded digits 0 ... 9
 A1...A18 denotes the numeric message
 A_n denotes a hexadecimal character 0 ... A
 Hexadecimal A is used to indicate a space character in the message

A new or repeated call is marked by altering the "paging A/B" flag.

M.2.1.6.4 Paging with additional alphanumeric message

The additional message is transmitted in consecutive 7A groups. Other group types may be transmitted in between:



types | 1 | types | 2 | types | 3

Each of the groups contains 4 characters coded in 8 bits each

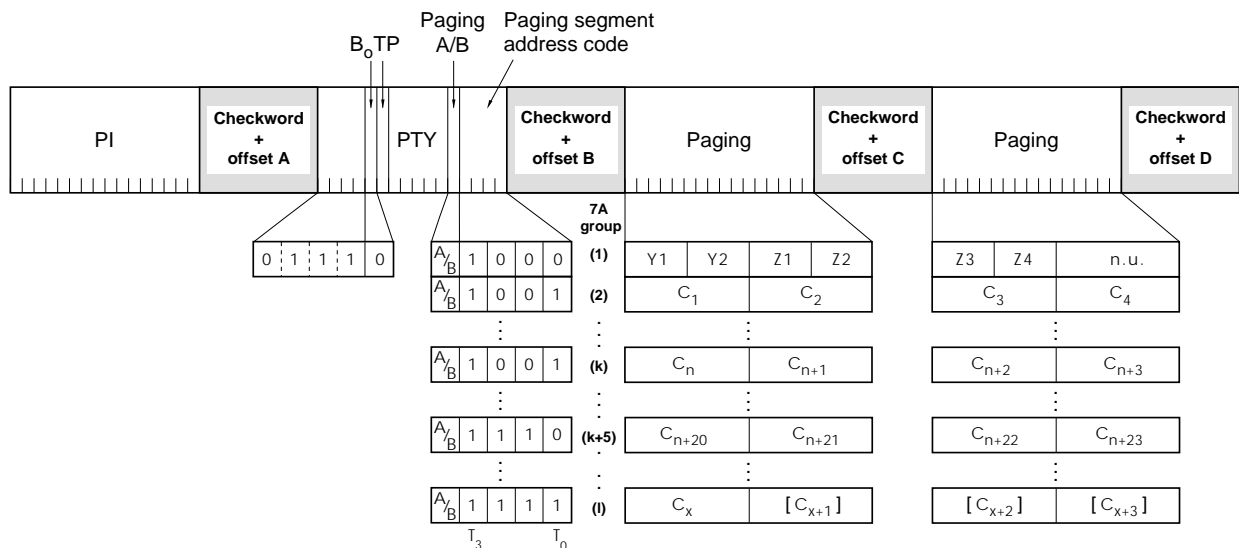

Figure M.5: Group type 7A paging with additional alphanumeric message

The paging segment address code is used to indicate the contents of blocks 3 and 4 in respective groups:

Table M.4

T_3	T_2	T_1	T_0	Contents of blocks 3 and 4
1	0	0	0	Group and individual code Y1Y2 Z1 to Z4
1	0	0	1	Message characters $C_{n...}C_{n+3}$
1	0	1	0	Message characters $C_{n+4...}C_{n+7}$
1	0	1	1	Message characters $C_{n+8...}C_{n+11}$
1	1	0	0	Message characters $C_{n+12...}C_{n+15}$
1	1	0	1	Message characters $C_{n+16...}C_{n+19}$
1	1	1	0	Message characters $C_{n+20...}C_{n+23}$
1	1	1	1	End of alphanumeric message: last four or fewer message characters

Paging segment address code is repeated cyclically 1001 ... 1110 for every 24 characters of the message transmitted (n is increased by 24 for each cycle).

End of message is indicated by the transmission of paging segment address code 1111 or by a new call (indicated by altering the "paging A/B" flag).

Maximum length of message is 80 characters.

Y1Y2 denotes the group code
 Z1...Z4 denotes the individual code within the group
 Y_n and Z_n denote BCD-coded digits 0 ... 9
 C_n...C_{n+23} denotes a message character coded in 8 bits according to annex E
 n.u. 8 last bits of block 4 of Group 1 not used

M.2.1.6.5 International paging with additional numeric 15 digit message

The additional numeric message is transmitted in two 7A groups following the first 7A group of the call. Other group types may be transmitted in between:

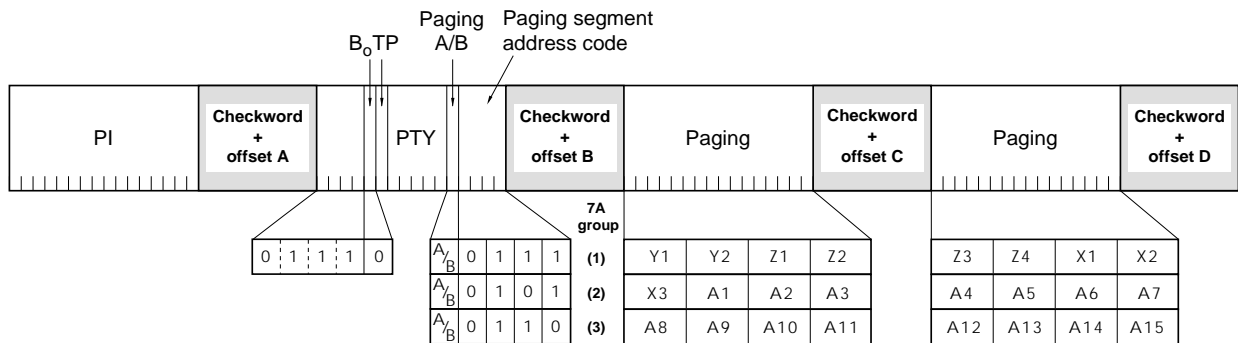
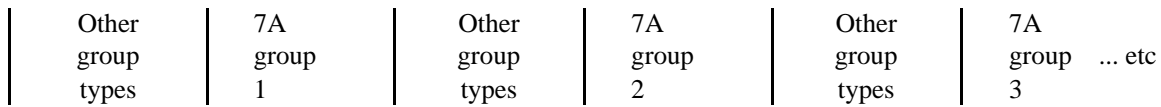

Figure M.6: Group type 7A paging with additional international 15 digit message

The paging segment address code is used to indicate the contents of block 3 and 4 in respective groups:

Table M.5

T_3	T_2	T_1	T_0	Contents of blocks 3 and 4 International 15 digit message
0	1	1	1	Group and individual code plus country code digit 1 and 2
0	1	0	1	Country code digit 3 plus additional information digits 1 to 7
0	1	1	0	Additional information digits 8 to 15

Y_1Y_2 denotes the group code
 $Z_1...Z_4$ denotes the individual code
 $X_1...X_3$ denotes the country code according to CCITT Rec. E212
 X_n, Y_n and Z_n denote BCD-coded digits 0 ... 9
 $A_1...A_{15}$ denotes the additional numeric message
 A_n denotes a hexadecimal character 0 ... A.
 Hexadecimal A is used to indicate a space character in the message.

A new or repeated call is marked by altering the "paging A/B" flag.

M.2.1.6.6 Functions message in international paging

The functions message is transmitted in one 7A group following the first 7A group of the call.

Other group types may be transmitted in between:

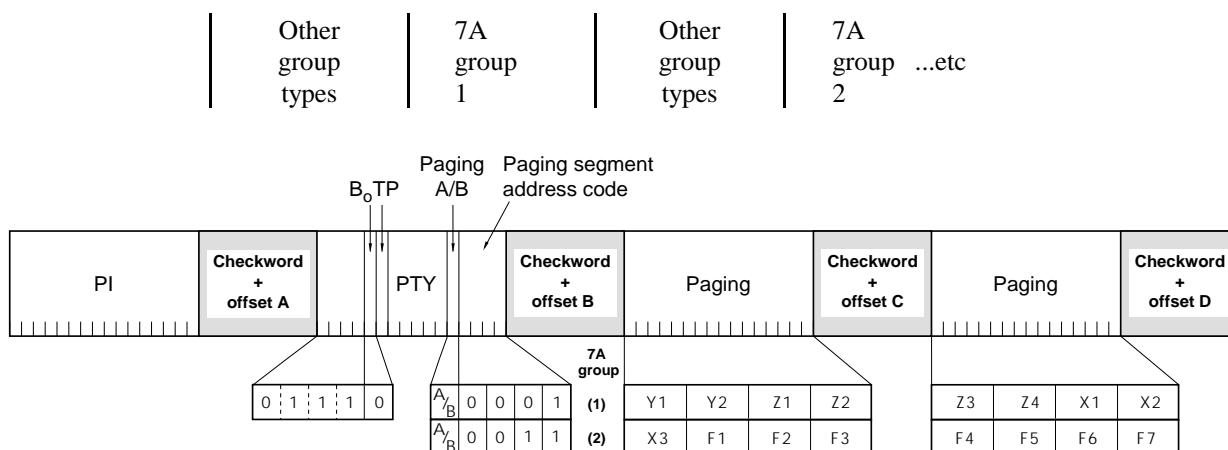

Figure M.7: Functions message in international paging

The paging segment address code is used to indicate the contents of block 3 and 4 in respective groups:

Table M.6

T_3	T_2	T_1	T_0	<i>Contents of blocks 3 and 4 Functions message</i>
0	0	0	1	Group and individual code plus country code digit 1 and 2
0	0	1	1	Country code digit 3 plus functions message number 1 to 7

Y1Y2 denotes the group code
 Z1...Z4 denotes the individual code
 X1...X3 denotes the country code according to CCITT Rec. E212
 X_n, Y_n and Z_n denote BCD-coded digits 0 ... 9
 F1...F7 denotes the functions message (e.g. for future applications such as control of paging receivers)
 F_n denotes a hexadecimal character 0 ... F

A new or repeated functions message is marked by altering the "paging A/B" flag.

M.3 Enhanced Paging

M.3.1 Introduction

Beside the paging system described in paragraph M.2, and that will be referred as "basic paging", this chapter introduces an "enhanced paging" protocol keeping the compatibility with the existing one.

The aim of enhanced paging protocol is to upgrade the battery life time of the pager, as well as easily permit regional and international paging, multi operator and multi services operation.

M.3.2 Multi operator / area paging

In order to offer real international paging services, it is important to identify completely the country during the channel locking, and so to use the Extended Country Code (ECC) as defined in 1A group, variant 0.

An Operator Code (OPC) is used to allow different operators to provide a paging service in the same country, as well as a Paging Area Code (PAC) which allows a paging service with a coverage different from a nation wide one.

OPC, PAC, ECC and country part of the PI code make up the System Information (SI) and identify an unique network worldwide.

As Group Designation code is no longer used, the sharing of subscribers is still possible with PAC, nonetheless it is possible for a **same operator** to use on the **same network** basic **and** enhanced paging protocols, in this case Group Designation is only relevant for pagers using basic protocol.

Several ways of transmitting System Information (SI) are possible and may be alternatively used on the same network either at the operator's choice or for compatibility of the paging protocol with other applications. By using the group type 1A block 4 to transmit SI information, setting to zero the day of the month, then the rest of the block will not be interpreted by receivers using PIN and thus is free for radio paging information.

Note: **This coding of block 4 applies to all Variants of type 1A groups.**

For efficient scanning and channel locking of the receivers, SI must be transmitted as often as possible and to preserve compatibility with existing paging systems, 1A groups sent as second markers will be used.

M.3.2.1 Paging Area Code

This code is defined for each country and operator. 6 bits are assigned to enable the definition of 63 paging service areas.

The figure zero transmitted by an encoder means it sends messages for all paging areas of the paging service provider, and the figure zero assigned to a pager means that it belongs to all paging service areas and as a consequence does not need to look for PAC information.

M.3.2.2 Operator Code

OPC allows to have more than one operator to function in a country. Within a country, each operator should have its own unique code. OPC is coded on 4 bits to allow 15 operators.

The figure zero is not valid for an operator, and means that enhanced paging protocol is not implemented on the channel (see note 1 in M.3.2.4.3).

M.3.2.3 Extended Country Code

In order to uniquely define each country for enhanced international service, ECC is used as defined in 1A group, variant 0.

For the majority of pagers which are used in national mode, checking the country part of the PI code will be sufficient for channel locking, full ECC being checked in a second step, especially for pagers set in international mode.

M.3.2.4 Description of usage of 1A group variants for paging

M.3.2.4.1 Use of 1A variant 0 when PIN information is transmitted

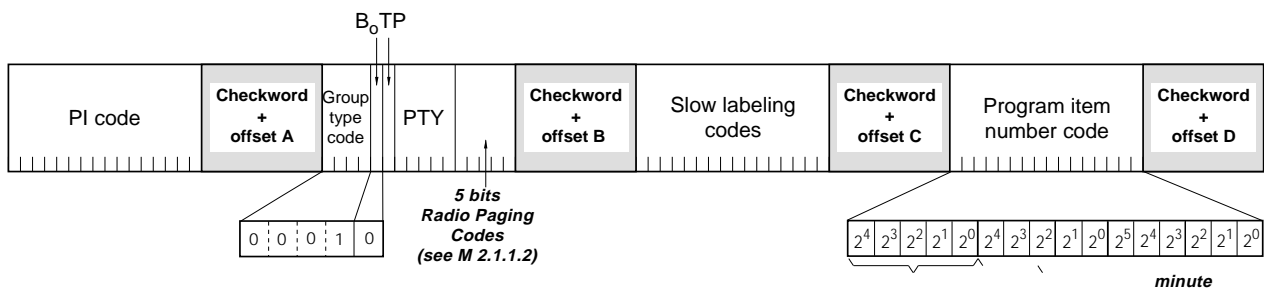

Figure M.8: variant 0 of 1A group with PIN

1A group, variant 0 is defined for transmitting ECC which is part of the paging System Information. The four bits $2^{11} - 2^8$ of the slow labeling code (see Figure 8a and M.10a) which are used to transmit the OPERator Code (OPC).

It is important that broadcasters using type 1A group, variant 0, without transmitting paging, set these four bits to zero.

Pagers for which PAC is set to zero do not need any more information than that contained in block 3 of variant 0 and PI's country part to lock to a channel.

M.3.2.4.2 Use of 1A variant 2 when PIN information is transmitted

¹⁾ and ²⁾: See notes below figure M.10b

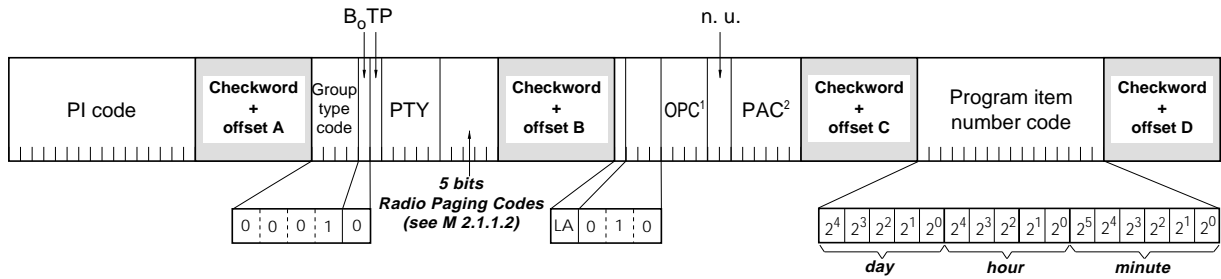

n.u. means not used

Figure M.9: variant 2 of 1A group with PIN

Variant 2 is dedicated to paging and will transmit OPC and PAC.

The four bits $2^{11} - 2^8$ of the slow labeling code (see Figure 9a and M.10b) transmit the OPC as in variant 0.

The two bits $2^7 - 2^6$ of the slow labeling code (see Figure 9a and M.10b) are set to zero, and must be ignored by the pager.

All values are reserved for future use.

The six bits $2^5 - 2^0$ of the slow labeling code (see Figure 9a and M.10b) transmit the PAC.

M.3.2.4.3 Use of PIN field when no valid PIN information is transmitted

By setting to zero the five first bits (day information bits) of block 4, all receivers except enhanced protocol pagers will disregard the rest of the block which does not represent valid PIN information.

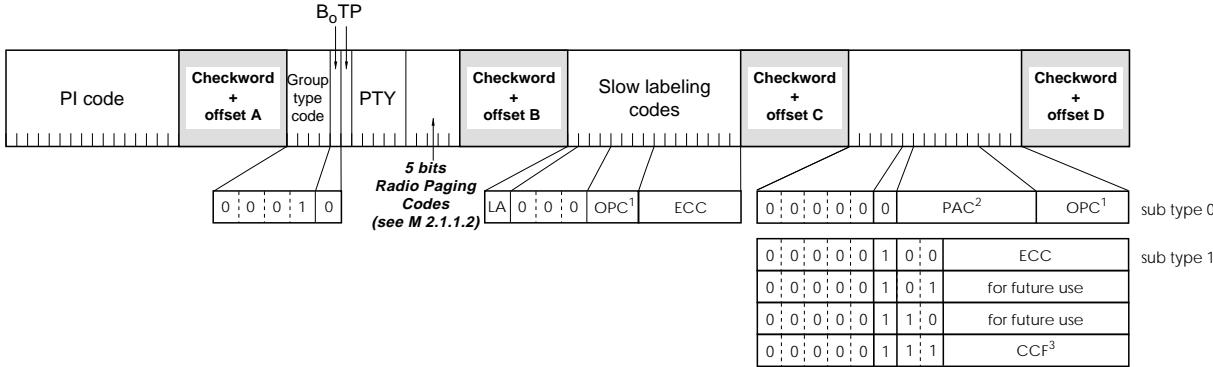

Figure M.10a: variant 0 of 1A group without PIN

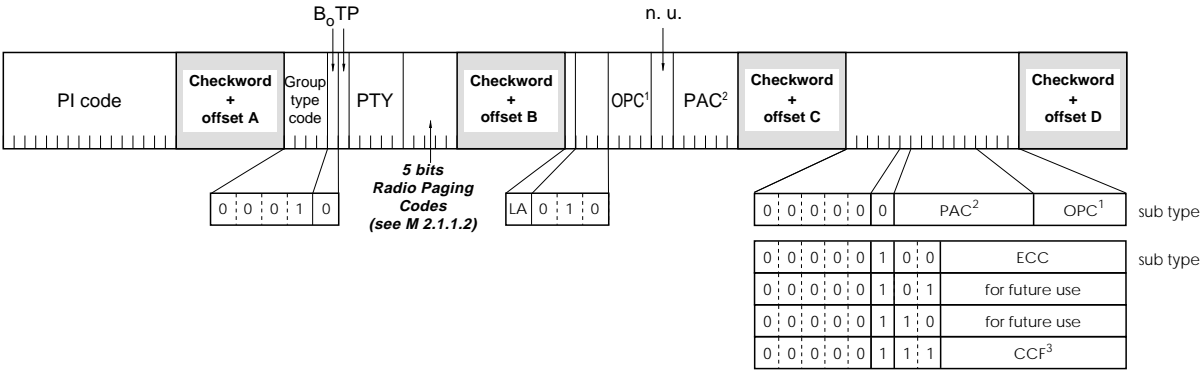

Figure M.10b: variant 2 of 1A group without PIN

Notes:

1. OPC : Operator code (see M.3.2.2). If these 4 bits are set to 0, it indicates that there is no enhanced paging service on the channel.
2. PAC : Paging Area Code (see M.3.2.1).
3. CCF : Current Carrier Frequency. This code represents the frequency value of the carrier to which the receiver is locked according to AF (see 3.2.1.6.1).

The eleven remaining bits are used to transmit the paging System Information. This gives an efficient tool to preserve compatibility with applications requiring other 1A variants.

Bit 2^4 (hour information field of figure M.9) is now used to define a sub type :

- If set to 0, the rest of the block transmits PAC in bits $2^3 - 2^0$ (hour information field of figure M.9) and in bits $2^5 - 2^4$ (minute information field of figure M.9), and OPC in bits $2^3 - 2^0$ (minute information field of figure M.9).
- If set to 1, bits $2^3 - 2^2$ (hour information field of figure M.9) are used to define a sub-usage code:

Table M.7

2^3	2^2	<i>Usage of the remaining 8 bits</i>
0	0	Transmit ECC
0	1	Reserved for future use, must be set to zero
1	0	Reserved for future use, must be set to zero
1	1	Transmit CCF

M.3.2.5 Compatibility with other RDS applications and timing of 1A groups

M.3.2.5.1 General rule

If no other RDS application using 1A group is broadcast on the network, it is strongly recommended to use variant 2 of 1A group. The following paragraph explains the different possibilities. More detailed information is given however in the implementation guidelines .

M.3.2.5.2 Compatibility and timing of 1A groups

Group type 4A is transmitted at the start of every minute. Group type 1A is transmitted at least once per second. The OPC code is transmitted in the blocks 3 and 4 in order to allow receivers to process a fast locking on or a fast leaving of the channel in case variants of 1A groups, different from 0 and 2, are transmitted.

A pager using enhanced protocol may alternatively find the relevant System Information (SI) in 1A group variant 0, 1A group variant 2 or in block 4 of any 1A group when no PIN is broadcast. This protocol allows to remain compatible with other applications as it will be recommended below :

General remarks :

1. *Var. means variant, sty means sub type.*
2. *In case of interval 0, the first 1A group is replaced by 4A group. For M.3.2.5.2.3 and M.3.2.5.2.4, variant 0, sub type 0 is obligatory for 1A group as 2nd marker.*
3. *It is recommended to insert by at least one type 1A group, variant 2, sub type 1 with ECC, or one type 1A group variant 0, sub type 0 per interval as 1st marker, or as 2nd marker for interval 0.*
4. *1B groups are broadcast with valid PIN in order to respect the 0.5 second repetition time.*
5. *When two 1B groups are broadcast between two 1A groups, the first one must be as close as possible of the first 1A or 4A groups, or the second one must be as close as possible of the second 1A or 4A groups.*
6. *1B groups are 0.5 second far between 1A groups.*
7. *The use of 1A group, variants 0 or 2 during the broadcasting of the PIN is obligatory, which means that the compatibility with other applications is restricted during this period (< 2 seconds).*
8. *13A groups are optional and are just represented here for information.*

M.3.2.5.2.4 Network using PIN and other variants of 1A group

A mixing of the above two methods is used, the only constraint being to transmit OPC every second, PAC each two seconds and ECC at least once in the interval.

Start of :

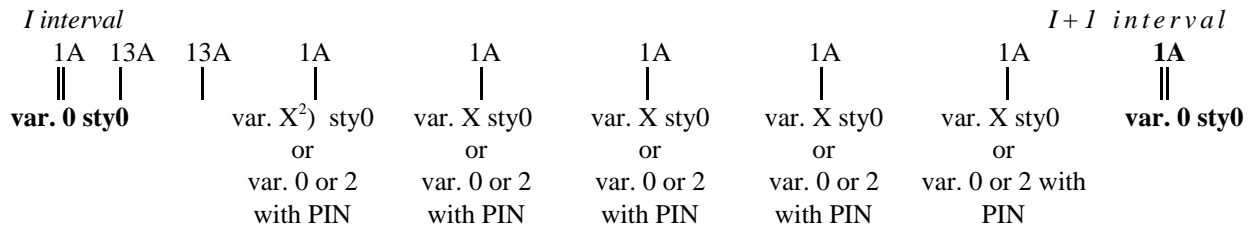

M.3.2.6 Services using multi operator/area

Knowing that operator and area are coded individually, a pager can select the right network without any risk of error. Combinations of different operators and/or areas are possible by programming SI for all the elementary services in the pager.

M.3.2.7 Locking criteria

The pagers designed to be used with this new enhanced paging protocol must ignore the criteria described in paragraphs M.2.1.4 and M.2.1.5, and respect the following ones:

- M.3.2.7.1* The pager searches for one of the offset words A...D. When this is found, it searches for the next expected offset word at a distance of: n times 26 bits, n = 1 ... 6. When two offset words have been found, the pager is synchronized to both block and group. After block and group synchronization, the pager must find the correct System Information (country part of the PI code, OPerator Code and Paging Area Code in the national mode, country part of the PI code, Extended Country Code and OPerator Code in the international mode). Otherwise the pager must leave the channel.
- M.3.2.7.2* The pager shall leave the channel within one second if OPC (1A group) is set to 0.
- M.3.2.7.3* When scanning the frequency band, block and group synchronization must occur within one second and correct System Information must be found within two³⁾ seconds after block and group synchronization. Otherwise the pager must leave the channel.
- M.3.2.7.4* When locking to the channel after battery saving mode, block and group synchronization and the reception of the correct System Information must occur within two³⁾ seconds. Otherwise the pager must leave the channel.
- M.3.2.7.5* When locking to the channel after battery saving mode, the reception of the parity of the minute for pagers operating in the 120 seconds cycle mode must occur within 6 seconds.

²⁾ X≠0 and X≠2

³⁾ If PIN is broadcast at the same time, the pager must find the correct SI within three seconds after block and group synchronization.

M.3.2.8 Loss of synchronization

- M.3.2.8.1* When 43 out of the last received 45 blocks have a syndrome different from 0 (for the respective offset words), the channel locking is lost and the pager shall scan the band for a better channel.
- M.3.2.8.2* If the System Information is no longer in accordance with the one programmed in the pager, the pager shall leave the channel and scan the band for a new one.

M.3.2.9 International paging

To be able to receive international calls, the user must activate the pager's international mode. The pager contains a list of countries covered by the user's subscription with the relevant operator codes.

Because the user can forget to activate the pager's international mode, it is recommended that the pager first check ECC before displaying the first message after locking.

M.3.2.9.1 Selection of the channel

To select the correct channel, the pager must check the full SI. These codes, broadcast in 1A groups, are stored in a table which indicates to the pager which local operator is providing the international connection with its own paging service provider.

M.3.2.9.2 International alphanumeric/variable length numeric or function messages

The figures M.17, M.18 and M.19 describe the new international message format. The pager must check the 6-digits national address + the 3-digits country code (according to CCITT Rec. E212) + the 4-bits OPC code, which together define its unique international address. This OPC code is the original one (from the national paging service provider) and has no link with the one broadcast in the 1A group.

M.3.3 Extension of paging addressing mode

The basic paging system allows 1 million addresses. Knowing that pagers have 2 or more addresses, and that transmitter network group designation can limit the use of address range, the coding is extended using hexadecimal coding instead of BCD coding. Only the digit Z4 (see M.2.1.6.2) of the individual address remains BCD-coded to keep the compatibility with interval numbering.

Thus the new total capacity becomes : $16^5 \times 10 = 10\,485\,760$ addresses.

This extension can be implemented on existing network independently of the other enhanced features, but must be introduced in case of enhanced paging protocol implementation.

For basic paging protocol, the group designation code assignment is described below :

Table M.8

B_4	B_3	B_2	<i>Group codes</i>	<i>Percentage</i>
0	0	0	No basic paging on channel	
0	0	1	00 - FF	100
0	1	0	00 - 3F + A0 - DF	50
0	1	1	40 - 9F + E0 - FF	50
1	0	0	40 - 6F + E0 - EF	25
1	0	1	70 - 9F + F0 - FF	25
1	1	0	00 - 1F + A0 - BF	25
1	1	1	20 - 3F + C0 - DF	25

M.3.4 Battery saving mode

The principle of the battery saving mode described in paragraph M.2.1.3 is based on a time division of 10 intervals per minute during which only the pagers belonging to the transmitted interval (in accordance with digit Z4 of its individual code (see M.2.1.6.2)) are activated. The enhanced protocol provides tools to dramatically improve the performances achieved with basic paging in this field.

M.3.4.1 Message notification / 13A groups sub type description

M.3.4.1.1 Introduction

The 13A group is organized in sub types. Sub types 0, 1 and 2 are transmitted at the beginning of each interval (just following the first 1A group), this group informs the pager of the possibility of presence of messages: if there is no message, the pager can immediately enter the battery saving mode instead of waiting until the end of its interval.

If the pager misses the 13A group, it must follow the rules described in M.3.4.4.

By transmitting the number of the current interval at the beginning of the interval instead of collecting it in many 1A groups, the acquisition can be optimized, thus improving the battery life time.

M.3.4.1.2 Message notification

Each pager is identified by a group code Y1Y2 followed by an individual code Z1Z2Z3Z4 (see M.2.1.6.2).

The last digit Z4 indicates the interval number. The Z2Z3 digits determine a sub group for message notification to which a pager belongs. Thus 256 sub groups have been defined (00-FF).

For a given interval and a given minute, the 256 sub groups are represented by 50 bits transmitted in two 13A groups, each bit indicating if a message for at least one pager belonging to the corresponding sub group will be transmitted during the considered interval. However, one 13A group can be used instead of two, if type 7A group traffic is important, which is the case for alphanumeric messages. In that case only 25 notification bits are used.

In worst case of traffic it is even possible to skip 13A group transmission.

The correspondence between the hexadecimal-coded ZZZ3 digits and the address notification bit, is given in the tables of section M.3.6.

The address notification bit is set to 1 if at least one pager belonging to a sub group attached to this notification bit will receive a message, otherwise the address notification bit is set to 0.

M.3.4.1.3 Sub type description

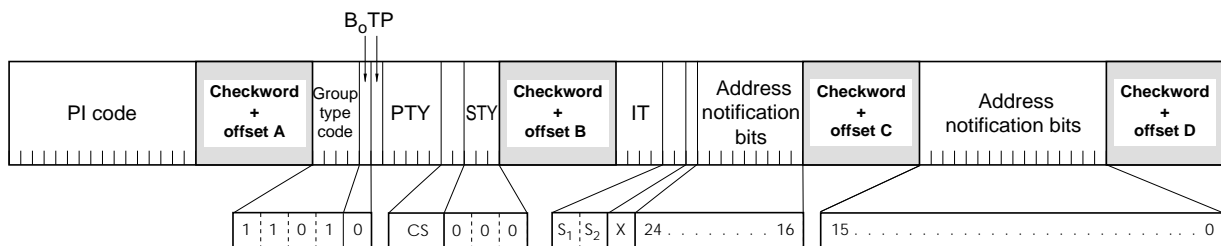

Figure M.11a: sub type 000 - Group type 13A

The 13A group, sub type 000, is used when only 25 address notification bits (one 13A group) are used. This group is immediately located after the 1A group starting the interval.

STY denotes the sub type of the group.

X is reserved for future use.

CS (Cycle Selection) denotes the parity of the minute if a two minute cycle is implemented, and indicates if only one minute cycle or a mixing of both (one and two minutes cycle) is implemented.

Table M.9

CS		
0	0	1 minute cycle
0	1	reserved for future use
1	0	2 minutes cycle or mixed (even)
1	1	2 minutes cycle or mixed (odd)

IT denotes the paging interval numbering.

S₁ and **S₂** indicate whether messages are sorted or not.

Table M.10

S ₁	S ₂	
0	0	not sorted
0	1	reserved for future use
1	0	sorted in ascending order
1	1	sorted in descending order

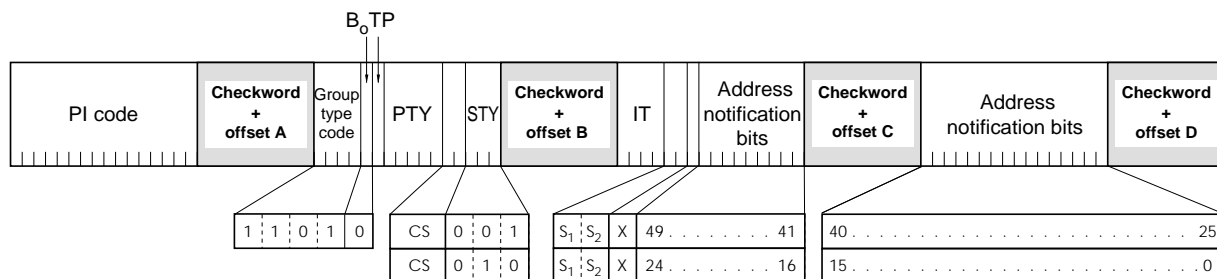

Figure M.11b: Sub type 001 and 010 - Group type 13A

The 13A group, sub type 001, is used when 50 address notification bits (two 13A groups) are used. This group is immediately located after the 1A group starting the interval and represent high order notification bits.

The 13A group, sub type 010, is the second of the two 13A groups when 50 address notification bits (two 13A groups) are used. This group is immediately located after the 13A group, sub type 001, and represent low order notification bits.

Warning:..” replace by “Warning : the address notification bits do not refer to the same pagers sub groups in sub types 000 (25 bits) and 001 with 010 (50 bits).

The sub type 011 will be used to carry information for Value Added Services (VAS) pagers.

M.3.4.2 One or two minutes cycles

M.3.4.2.1 Cycle structure

120 seconds or 60 seconds main cycle is used depending on the pager programming. A pager operating on a 120 seconds cycle wakes up from battery saving mode once every two minutes either during an even or odd minute according to its Z3 digit (see chapter M.3.6). A pager operating on a 60 seconds cycle wakes up from battery saving mode once every minute.

1A group cycle structure is described in M.3.2.5.

If no 13A group is broadcast or if the receiver cannot decode the CS correctly, one minute cycle time has to be followed.

M.3.4.2.2 Priority between the different kinds of group

When 13A groups are used, they must follow immediately the 1A or 4A group (sub types 000, sub types 001 or 010).

Either zero, one or two 13A groups may be used, and the number may be changed dynamically by the operator or encoder as a function of paging traffic.

13A groups will be inserted automatically by encoders.

M.3.4.2.3 Loss of interval synchronization

The pager shall be considered to have lost its interval synchronization if any of the following criteria is fulfilled:

- if there is a paging call within the pagers' own interval to a pager not belonging to the interval or the two preceding intervals, or
- the interval value received from a 13A or 1A groups is not the one expected, or
- the parity of the minute is not the one expected for two minutes cycle receivers.

M.3.4.3 Organisation of the messages within an interval

At the broadcaster's discretion messages may be sent in random order or with the individual address value of the pager sorted, two minutes in ascending order and two minutes in descending order. A pager may enter battery saving mode when its address has been passed.

M.3.4.4 Battery saving mode criteria

The pagers designed to be used with this new enhanced paging protocol must ignore the criteria described in paragraph M.2.1.3

The pager may enter the battery saving mode after the start of its own interval if any of the following criteria is fulfilled:

- if at least 10 groups differing from 7A group have been received;
- if a paging call, belonging to an interval different from the pagers' own and the two preceding intervals, has been received;
- after the start of the third interval after its own interval;
- if the address notification bits in the beginning of the interval in the 13A sub group types 000, 001 or 010 corresponding to the pagers' address are set to zero and the related 13A groups have been received correctly;
- if at least one paging call having individual address value below or above the pagers' own (according to the sorting order) have been received.

M.3.5 Group type 7A message format

M.3.5.1 General

The group type 7A message format is as described in the chapter M.2.1.6, without any change. The table M.2 is extended to new types of messages:

Table M.11

T_3	T_2	T_1	T_0	Message contents:
0	0	0	0	No additional message
0	0	0	1	Part of functions message
0	0	1	X	10 digit numeric message or part of functions message
0	1	X	X	18 digit numeric message or 15 digit numeric message in international paging
1	X	X	X	Variable-length message
1	1	1	1	Last group of a variable-length message
X indicates state 0 or 1				

NOTE: If variable-length (numeric, international numeric, international alphanumeric, functions, international functions) or tone-only paging calls are received by pagers designed according to the specification EN 50067:1992 then incorrect display of messages may result.

M.3.5.2 Paging without additional message: Tone-only message

The value of the control byte X1X2 is: 0 0 0 R P3 P2 P1 P0 (see Table M.12)

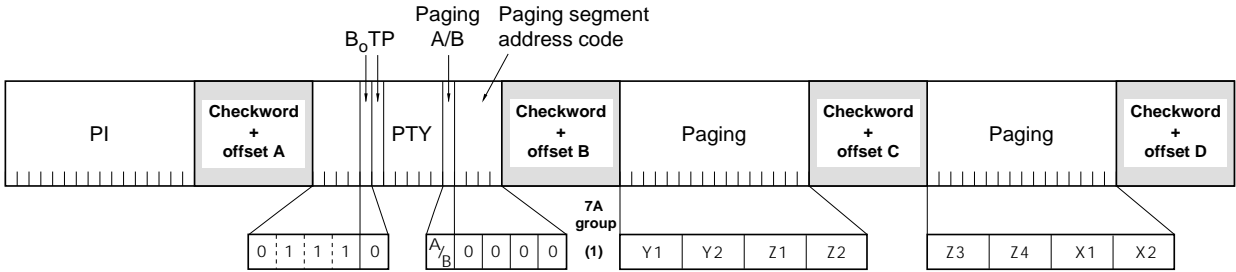

Figure M.12: Tone-only message

- Y1Y2 denotes the group code
- Z1 ... Z4 denotes the individual code within the group
- X1X2 denotes the control byte
- Yn and Zn denote BCD-coded digit 0 ... 9
- Xn denotes a hexadecimal character 0 ... F

The paging segment address code, used to indicate the contents of blocks 3 and 4, is set to 0000. The control byte X1X2 is defined in M.3.5.3

M.3.5.3 Paging with additional variable-length message

The additional message is transmitted in consecutive 7A groups. Other group types may be transmitted in between:

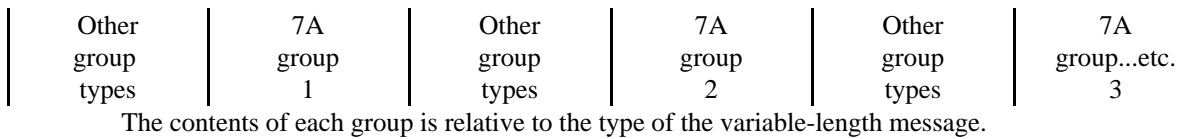
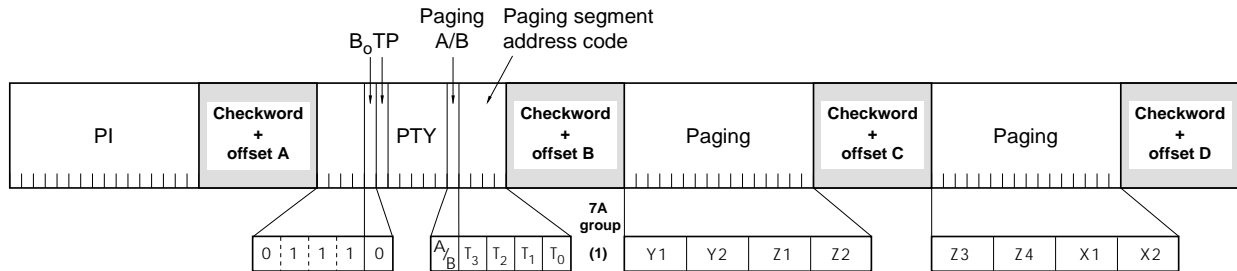

Figure M.13: First 7A group of a variable-length message

Y1Y2 denotes the group code
 Z1...Z4 denotes the individual code within the group



X1X2 denotes the control byte
 Yn and Zn denote BCD-coded digits 0 ... 9
 Xn denotes a hexadecimal character 0 ... F

The control byte is used to indicate the type of the variable-length message; it also includes a paging call counter and a paging call repetition flag.

Table M.12: description of the control byte

<i>Paging segment address code</i> (in the 2nd block of each 7A group)				<i>Control byte</i> X1X2 (last byte of the 4th block of the 1st 7A group)								<i>Type of the message</i>
T ₃	T ₂	T ₁	T ₀	9	10	11	12	13	14	15	16	
0	0	0	0	E ₂	E ₁	E ₀	R	P ₃	P ₂	P ₁	P ₀	Tone-only message (See 3.2.6.2.6.2)
1	X	X	X	0	0	NI	R	P ₃	P ₂	P ₁	P ₀	Alphanumeric message
1	X	X	X	0	1	NI	R	P ₃	P ₂	P ₁	P ₀	Variable-length numeric message
1	X	X	X	1	0	NI	R	P ₃	P ₂	P ₁	P ₀	Reserved for future use
1	X	X	X	1	1	NI	R	P ₃	P ₂	P ₁	P ₀	Variable-length functions message

Bits 9 and 10 denote the type of the variable-length message
 NI denotes the national/international bit
 NI = 0 : National message
 NI = 1 : International message
 R denotes the paging call repetition flag
 P₀ ... P₃ denote the paging call counter
 E₂, E₁, E₀ denote the extended message field for tone-only messages. Use according to Operator's definition.

Table M.13: Use of paging call repetition flag

Bit 12 (R)	Description
0	Indicates the original (first time) transmission of a paging call, or that the repetition flag is not implemented
1	Indicates the repetition of an already transmitted paging call

Bits 13-16, designated as P3-P0, form the paging call counter. The counter is individual to each receiver address number⁴⁾, and is incremented by 1 every time a call is initially sent to the receiver address number, independent of the message type used. When the call is repeated, the counter must have the same value as originally sent.

The paging call counter may be used in the receiver to indicate that no messages have been lost.

Valid values for the paging call counter are 1 to 15, while the value 0 is used when the paging call counter is not implemented. The paging call counter is used in a loop so that value 1 will follow after value 15.

M.3.5.4 National paging with additional alphanumeric message

The value of the control byte X1X2 is: 0 0 NI R P3 P2 P1 P0 with NI = 0

Each of the groups contains 4 characters coded in 8 bits each.

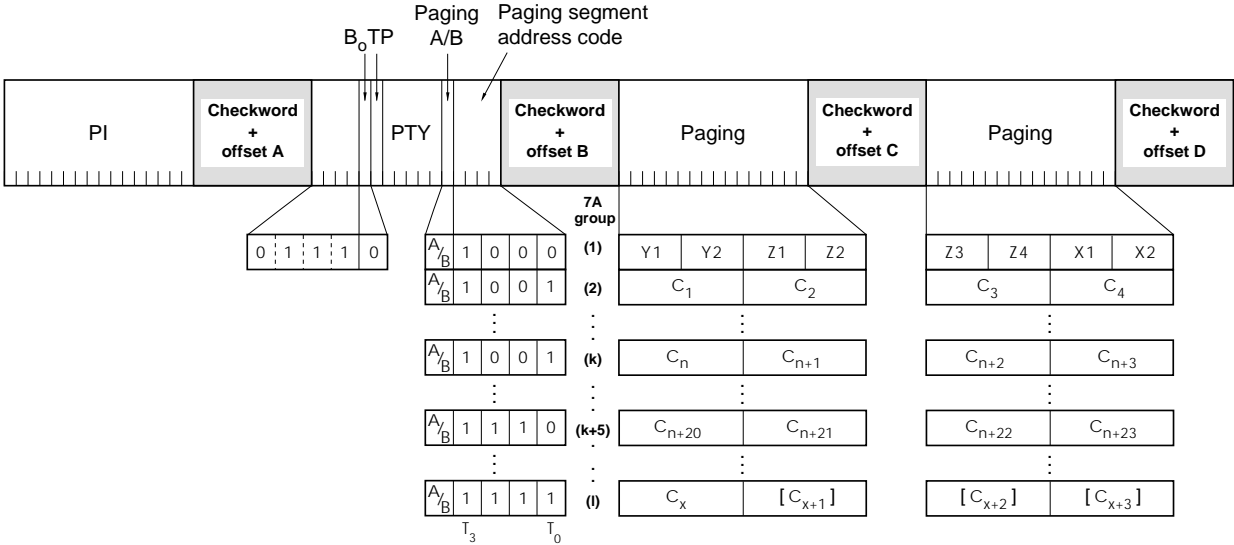

Figure M.14: Group type 7A national paging with additional alphanumeric message

⁴⁾ The receiver address number is the Group code + the individual code = Y1Y2Z1Z2Z3Z4

The paging segment address code is used to indicate the contents of blocks 3 and 4 in respective groups:

Table M.14

T_3	T_2	T_1	T_0	<i>Contents of blocks 3 and 4</i>
1	0	0	0	Group and individual code Y1Y2 Z1 to Z4 and control byte X1X2
1	0	0	1	Message characters $C_{n...}C_{n+3}$
1	0	1	0	Message characters $C_{n+4...}C_{n+7}$
1	0	1	1	Message characters $C_{n+8...}C_{n+11}$
1	1	0	0	Message characters $C_{n+12...}C_{n+15}$
1	1	0	1	Message characters $C_{n+16...}C_{n+19}$
1	1	1	0	Message characters $C_{n+20...}C_{n+23}$
1	1	1	1	End of alphanumeric message: last four or fewer message characters

Paging segment address code is repeated cyclically 1001 ... 1110 for every 24 characters of the message transmitted (n is increased by 24 for each cycle).

End of message is indicated by the transmission of paging segment address code 1111 or by a new call (indicated by altering the "paging A/B" flag).

Recommended maximum length of message is 80 characters.

- Y1Y2 denotes the group code
- Z1...Z4 denotes the individual code within the group
- X1X2 denotes the control byte
- Y_n and Z_n denote BCD-coded digits 0 ... 9
- X_n denotes a hexadecimal character 0 ... F
- $C_{n...}C_{n+23}$ denotes a message character coded in 8 bits
 according to annex E

M.3.5.5 National paging with additional variable-length numeric message

The value of the control byte X1X2 is: 0 1 NI R P3 P2 P1 P0 with NI = 0

Each of the groups contains 8 digits coded in 4 bits each

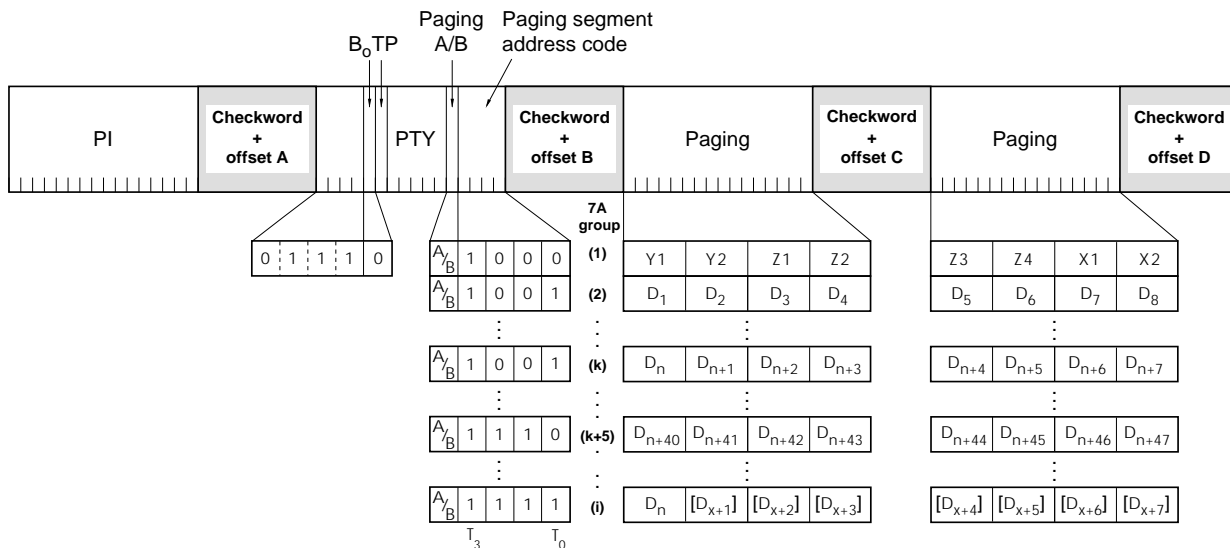

Figure M.15: Group type 7A national paging with additional variable-length numeric message

The paging segment address code is used to indicate the contents of blocks 3 and 4 in respective groups:

Table M.15

T_3	T_2	T_1	T_0	Contents of blocks 3 and 4
1	0	0	0	Group and individual code Y1Y2 Z1 to Z4 and control byte X1X2
1	0	0	1	Message digits $D_n \dots D_{n+7}$
1	0	1	0	Message digits $D_{n+8} \dots D_{n+15}$
1	0	1	1	Message digits $D_{n+16} \dots D_{n+23}$
1	1	0	0	Message digits $D_{n+24} \dots D_{n+31}$
1	1	0	1	Message digits $D_{n+32} \dots D_{n+39}$
1	1	1	0	Message digits $D_{n+40} \dots D_{n+47}$
1	1	1	1	End of variable-length numeric message: last eight or fewer message digits

Paging segment address code is repeated cyclically 1001 ... 1110 for every 48 digits of the message transmitted (n is increased by 48 for each cycle).

End of message is indicated by the transmission of paging segment address code 1111 or by a new call (indicated by altering the "paging A/B" flag).

Recommended maximum length of message is 160 digits.

Y1Y2 denotes the group code
 Z1...Z4 denotes the individual code within the group
 X1X2 denotes the control byte
 Y_n and Z_n denote BCD-coded digits 0 ... 9
 X_n denotes a hexadecimal character 0 ... F
 D_n...D_{n+47} denotes a hexadecimal character 0 ... A

Hexadecimal A is used to indicate a space character in the message

M.3.5.6 National paging with additional variable-length functions message

The value of the control byte X1X2 is: 1 1 NI R P3 P2 P1 P0 with NI = 0

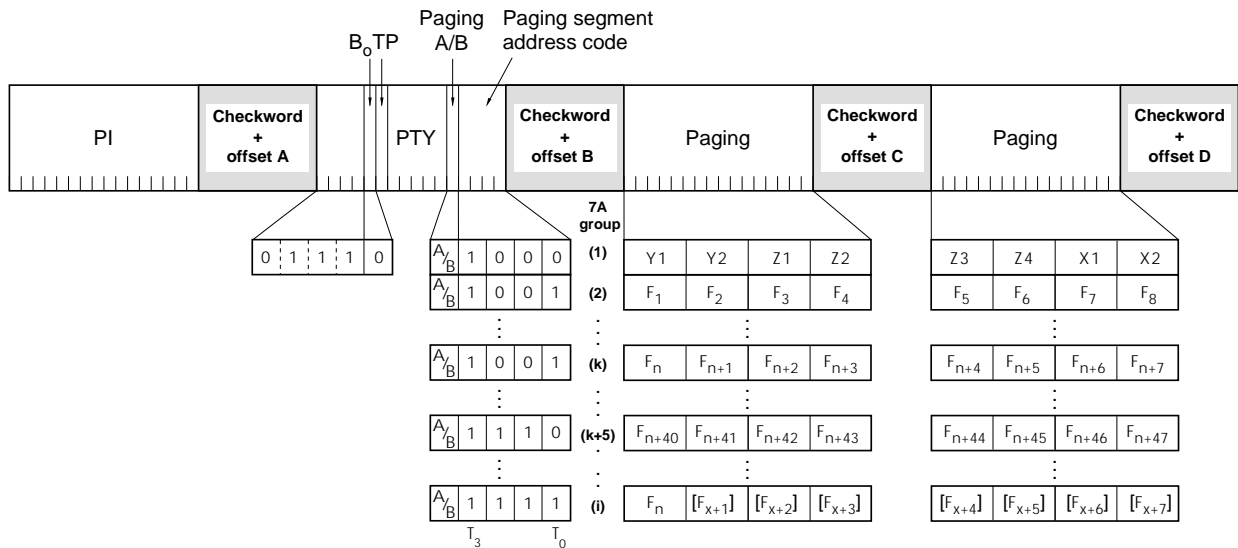

Each of the groups contains 8 digits coded in 4 bits each

Figure M.16: Group type 7A national paging with additional variable-length functions message

The paging segment address code is used to indicate the contents of blocks 3 and 4 in respective groups:

Table M.16

T_3	T_2	T_1	T_0	Contents of blocks 3 and 4
1	0	0	0	Group and individual code Y1Y2 Z1 to Z4 and control byte X1X2
1	0	0	1	Message digits $F_{n...}F_{n+7}$
1	0	1	0	Message digits $F_{n+8...}F_{n+15}$
1	0	1	1	Message digits $F_{n+16...}F_{n+23}$
1	1	0	0	Message digits $F_{n+24...}F_{n+31}$
1	1	0	1	Message digits $F_{n+32...}F_{n+39}$
1	1	1	0	Message digits $F_{n+40...}F_{n+47}$
1	1	1	1	End of variable-length functions message: last eight or fewer message digits

Paging segment address code is repeated cyclically 1001 ... 1110 for every 48 digits of the message transmitted (n is increased by 48 for each cycle).

End of message is indicated by the transmission of paging segment address code 1111 or by a new call (indicated by altering the "paging A/B" flag).

Recommended maximum length of message is 160 digits.

Y1Y2	denotes the group code
Z1...Z4	denotes the individual code within the group
X1X2	denotes the control byte
Y_n and Z_n	denote BCD-coded digits 0 ... 9
X_n	denotes a hexadecimal character 0 ... F
$F_{n...}F_{n+47}$	denotes a hexadecimal character 0 ... A
	Hexadecimal A is used to indicate a space character in the message

The variable-length functions messages can be used for example to program the pagers over the air. No special dedicated protocol is currently defined.

M.3.5.7 International paging with additional variable-length message

The bit NI (bit 11 in the control byte, see M.3.5.3, table M.12) is set to "1".

For all types of variable-length messages (alphanumeric, numeric and functions), the country code, according

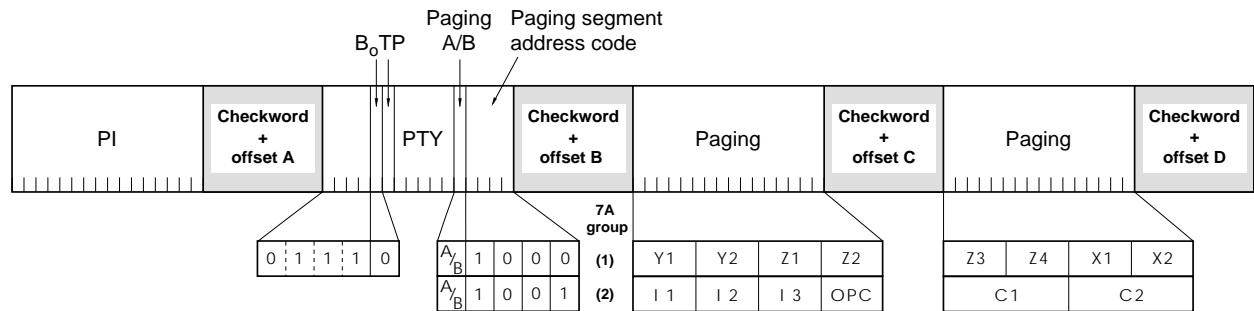

to CCITT Rec. E212, is added in the 3rd block of the second 7A group. This code is three BCD-coded digits long.

Figure M.17: The two first 7A groups of an international alphanumeric message

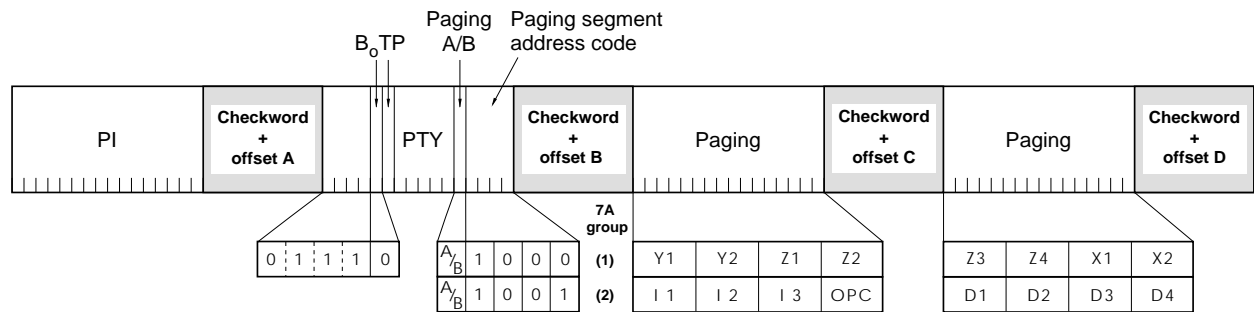

The value of the control byte X1X2 is: 0 0 NI R P3 P2 P1 P0 with NI = 1

Figure M.18: The two first 7A groups of an international variable-length numeric message

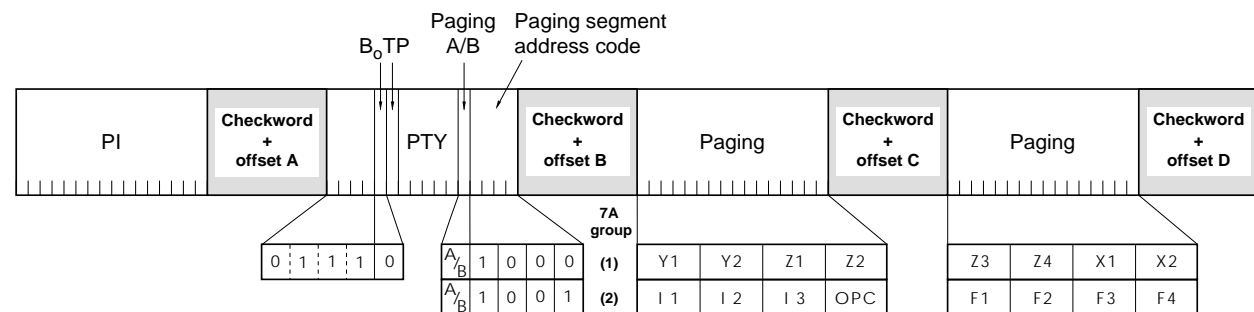

The value of the control byte X1X2 is: 0 1 NI R P3 P2 P1 P0 with NI = 1

Figure M.19: The two first 7A groups of an international variable-length functions message

The value of the control byte $X1X2$ is: 1 1 NI R P3 P2 P1 P0 with NI = 1

$Y1Y2$	denotes the group code
$Z1 \dots Z4$	denotes the individual code within the group
$X1X2$	denotes the control byte
$I1I2I3$	denotes the country code according to CCITT Rec. E212
$Y_n, Z_n,$ and I_n	denote BCD-coded digits 0 ... 9
X_n	denotes a hexadecimal character 0 ... F
$C_n \dots C_{n+23}$	denotes a message character coded in 8 bits according to annex E
$D_n \dots D_{n+47}$	denotes a hexadecimal character 0 ... A Hexadecimal A is used to indicate a space character in the message
$F_n \dots F_{n+47}$	denotes a hexadecimal character 0 ... F
OPC	Operator Code (see note 1 below figure M.10b)

The recommended maximum length of an international alphanumeric message is 78 characters.

The recommended maximum length of an international variable-length numeric message is 156 digits.

The recommended maximum length of an international variable-length functions message is 156 digits.

M.3.6 Address notification bit versus Pager individual address

The individual address of a pager is made of a group code (Y1Y2) and an individual code (Z1Z2Z3Z4). The Z2Z3 digits determine a sub group to which the pager is linked.

Z2Z3 are hexadecimal-coded, which determine 256 sub groups.

To improve the battery life time of the pager, address notification bits are allocated in 13A groups and are allocated to several of the 256 sub groups. If a message for at least one pager belonging to the corresponding sub group is going to be transmitted, the address notification bit attached to this sub group is set to 1.

The following table is given by :

$$\text{address notification bit - INTEGER} \left[\frac{\text{decimal-coded Z2 Z3}}{\left[\frac{256}{50} \right]} \right]$$

Table M.17

		Z3															
		0	1	2	3	4	5	6	7	8	9	A	B	C	D	E	F
Z2	0	0	0	0	0	0	0	1	1	1	1	1	2	2	2	2	2
	1	3	3	3	3	3	4	4	4	4	4	5	5	5	5	5	6
	2	6	6	6	6	7	7	7	7	7	8	8	8	8	8	8	9
	3	9	9	9	9	10	10	10	10	10	11	11	11	11	11	12	12
	4	12	12	12	13	13	13	13	13	14	14	14	14	14	15	15	15
	5	15	15	16	16	16	16	16	16	17	17	17	17	17	18	18	18
	6	18	18	19	19	19	19	19	20	20	20	20	20	21	21	21	21
	7	21	22	22	22	22	22	23	23	23	23	23	24	24	24	24	24
	8	25	25	25	25	25	25	26	26	26	26	26	27	27	27	27	27
	9	28	28	28	28	28	29	29	29	29	29	30	30	30	30	30	31
	A	31	31	31	31	32	32	32	32	32	33	33	33	33	33	33	34
	B	34	34	34	34	35	35	35	35	35	36	36	36	36	36	37	37
	C	37	37	37	38	38	38	38	38	39	39	39	39	39	40	40	40
	D	40	40	41	41	41	41	41	41	42	42	42	42	42	43	43	43
	E	43	43	44	44	44	44	44	44	45	45	45	45	45	46	46	46
	F	46	47	47	47	47	47	47	48	48	48	48	48	49	49	49	49

50 address notification bits are allocated

Note : Rows 8 to F can be obtained by adding 25 to rows 0 to 7.

M.4 Examples of the traffic handling capacity of the specified Radio paging system

The assumptions for the plotted graphs are:

- Numeric message (10 digits) is conveyed
- One paging call occupies two RDS groups per second
- Each time interval, assigned for battery saving, is fully utilized
- Formula:

$$S = \frac{G/2 * 3600}{C * (R+1)} * N$$

where S = number of subscribers
 G = number of 7A Groups/sec.
 R = number of repetitions
 N = number of networks
 C = busy-hour call rate

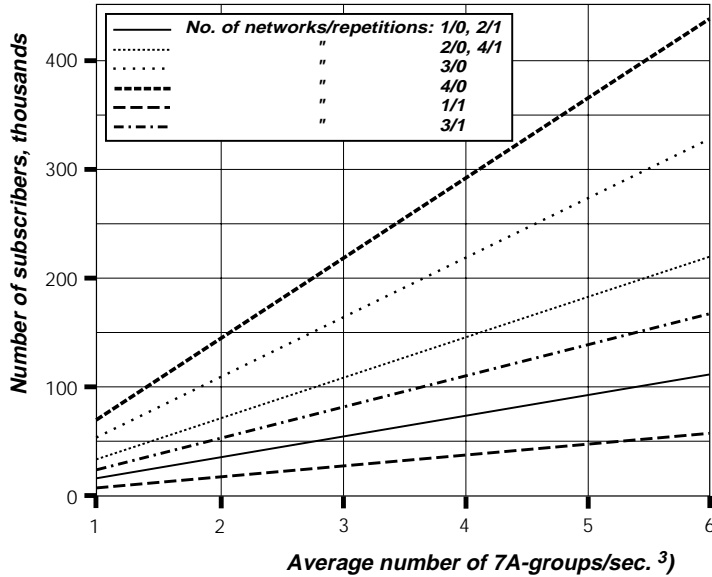

Figure M.20: Traffic handling capacity, busy hour, call rate = 0.10 calls/pager/hour

⁵ The Basic paging protocol also requires the transmission of one type 1A group per second and one type 4A group on every minute on each network (see M..2.1.1.1 and M.2.1.1.2).

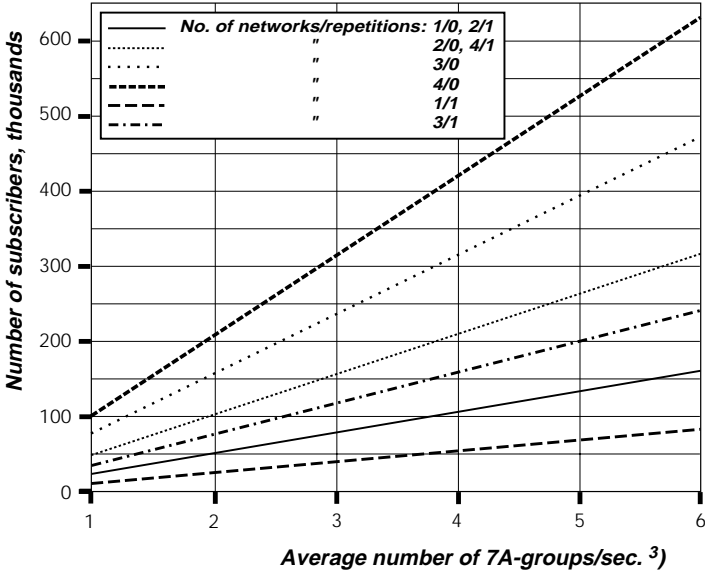

Figure M.21: Traffic handling capacity, busy hour, call rate = 0.067 calls/pager/hour

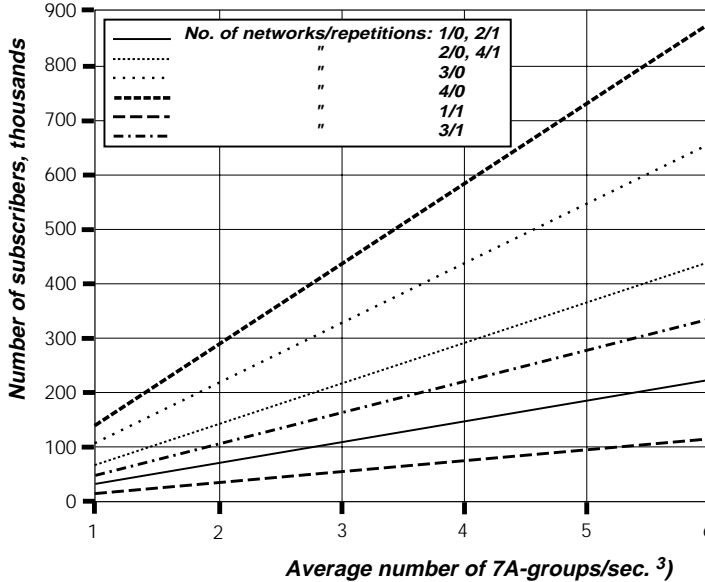

Figure M.22: Traffic handling capacity, busy hour, call rate = 0.05 calls/pager/hour

⁵ The Basic paging protocol also requires the transmission of one type 1A group per second and one type 4A group on every minute on each network (see M..2.1.1.1 and M.2.1.1.2).

ANNEX N (normative)

Country codes and extended country codes for countries outside the
European Broadcasting Area

N.1 African Broadcasting Area

COUNTRY/AREA	ISO CODE	SYMBOL FOR PI	ECC
Ascension Island		A	D1
Cabinda		4	D3
Angola	AO	6	D0
Algeria	DZ	2	E0
Burundi	BI	9	D1
Benin	BJ	E	D0
Burkina Faso	BF	B	D0
Botswana	BW	B	D1
Cameroon	CM	1	D0
Canary Islands	ES	E	E0
Central African Republic	CF	2	D0
Chad	TD	9	D2
Congo	CG	C	D0
Comoros	KM	C	D1
Cape Verde	CV	6	D1
Cote d'Ivoire	CI	C	D2
Democratic Republic of Congo	ZR	B	D2
Djibouti	DJ	3	D0
Egypt	E.G.	F	E0
Ethiopia	ET	E	D1
Gabon		8	D0
Ghana	GH	3	D1
Gambia	GM	8	D1
Guinea-Bissau	GW	A	D2
Equatorial Guinea	GQ	7	D0
Republic of Guinea	GN	9	D0
Kenya	KE	6	D2
Liberia	LR	2	D1
Libya	LY	D	E1
Lesotho	LS	6	D3
Mauritius	MU	A	D3
Madagascar	MG	4	D0
Mali	ML	5	D0
Mozambique	MZ	3	D2
Morocco	MA	1	E2
Mauritania	MR	4	D1
Malawi	MW	F	D0
Niger	NE	8	D2
Nigeria	NG	F	D1
Namibia	NA	1	D1
Rwanda	RW	5	D3
Sao Tome & Principe	ST	5	D1
Sechelles	SC	8	D3
Senegal	SN	7	D1
Sierra Leone	SL	1	D2

COUNTRY/AREA	ISO CODE	SYMBOL FOR PI	ECC
Somalia	SO	7	D2
South Africa	ZA	A	D0
Sudan	SD	C	D3
Swaziland	SZ	5	D2
Togo	TG	D	D0
Tunisia	TN	7	E2
Tanzania	TZ	D	D1
Uganda	UG	4	D2
Western Sahara	EH	3	D3
Zambia	ZM	E	D2
Zanzibar		D	D2
Zimbabwe	ZW	2	D2

N.2 Former Soviet Union

COUNTRY/AREA	ISO CODE	SYMBOL FOR PI	ECC
Armenia	AM	A	E4
Azerbaijan	AZ	B	E3
Belarus	BY	F	E3
Estonia	EE	2	E4
Georgia	GE	C	E4
Kazakhstan	KZ	D	E3
Kyrgyzstan	KG	3	E4
Latvia	LV	9	E3
Lithuania	LT	C	E2
Moldova	MD	1	E4
Russian Federation	RU	7	E0
Tajikistan	TJ	5	E3
Turkmenistan	TM	E	E4
Ukraine	UA	6	E4
Uzbekistan	UZ	B	E4

N.3 Allocations of symbols for countries in ITU Region 2

COUNTRY/AREA	ISO CODE	SYMBOL FOR PI	ECC
Anguilla	AI	1	A2
Antigua and Barbuda	AG	2	A2
Argentina	AR	A	A2
Aruba	AW	3	A4
Bahamas	BS	F	A2
Barbados	BB	5	A2
Belize	BZ	6	A2
Bermuda	BM	C	A2
Bolivia	BO	1	A3
Brazil	BR	B	A2
Canada	CA	B, C, D, E	A1
Cayman Islands	KY	7	A2
Chile	CL	C	A3
Colombia	CO	2	A3
Costa Rica	CR	8	A2
Cuba	CU	9	A2
Dominica	DM	A	A3
Dominican Republic	DO	B	A3
Ecuador	EC	3	A2
El Salvador	SV	C	A4
Falkland Islands	FK	4	A2
Greenland	GL	F	A1
Grenada	GD	D	A3
Guadeloupe	GP	E	A2
Guatemala	GT	1	A4
Guiana	GF	5	A3
Guyana	GY	F	A3
Haiti	HT	D	A4
Honduras	HN	2	A4
Jamaica	JM	3	A3
Martinique	MQ	4	A3
Mexico	MX	B, D, E, F	A5
Montserrat	MS	5	A4
Netherlands Antilles	AN	D	A2
Nicaragua	NI	7	A3
Panama	PA	9	A3
Paraguay	PY	6	A3
Peru	PE	7	A4
Puerto Rico	PR	1..9, A, B, D, E	A0
Saint Kitts	KN	A	A4
Saint Lucia	LC	B	A4
St Pierre and Miquelon	PM	F	A6
Saint Vincent	VC	C	A5
Suriname	SR	8	A4
Trinidad and Tobago	TT	6	A4
Turks and Caicos Islands	TC	E	A3
United States of America	US	1..9, A, B, D, E	A0
Uruguay	UY	9	A4
Venezuela	VE	E	A4
Virgin Islands [British]	VG	F	A5
Virgin Islands [USA]	VI	1..9, A, B, D, E	A0

N.4 Allocations of symbols for countries in ITU Region 3

COUNTRY/AREA	ISO CODE	SYMBOL FOR PI	ECC
Afghanistan	AF	A	F0
Saudi Arabia	SA	9	F0
Australia	AU		
Australia Capital Territory		1	F0
New South Wales		2	F0
Victoria		3	F0
Queensland		4	F0
South Australia		5	F0
Western Australia		6	F0
Tasmania		7	F0
Northern Territory		8	F0
Bangladesh	BD	3	F1
Bahrain	BH	E	F0
Myanmar [Burma]	MM	B	F0
Brunei Darussalam	BN	B	F1
Bhutan	BT	2	F1
Cambodia	KH	3	F2
China	CN	C	F0
Sri Lanka	LK	C	F1
Fiji	FJ	5	F1
Hong Kong	HK	F	F1
India	IN	5	F2
Indonesia	ID	C	F2
Iran	IR	8	F1
Iraq	IQ	B	E1
Japan	JP	9	F2
Kiribati	KI	1	F1
Korea [South]	KR	E	F1
Korea [North]	KP	D	F0
Kuwait	KW	1	F2
Laos	LA	1	F3
Macau	MO	6	F2
Malaysia	MY	F	F0
Maldives	MV	B	F2
Micronesia	FM	E	F3
Mongolia	MN	F	F3
Nepal	NP	E	F2
Nauru	NR	7	F1
New Zealand	NZ	9	F1
Oman	OM	6	F1
Pakistan	PK	4	F1
Philippines	PH	8	F2
Papua New Guinea	PG	9	F3
Qatar	QA	2	F2
Solomon Islands	SB	A	F1
Western Samoa	WS	4	F2
Singapore	SG	A	F2
Taiwan	TW	D	F1

COUNTRY/AREA	ISO CODE	SYMBOL FOR PI	ECC
Thailand	TH	2	F3
Tonga	TO	3	F3
U.A.E.	AE	D	F2
Vietnam	VN	7	F2
Vanuatu	VU	F	F2
Yemen	YE	B	F3

ANNEX P (normative)**Coding of MMBS Radio Paging, Data and In-House Application**

RDS/MMBS multiplex signaling format will transmit RDS data in a time multiplexed fashion between modulo-4 blocks of MMBS. To obtain RDS information from this data stream, the receiver must be able to decode the $E = 0$ offset. Details of the multiplex signaling are given in this appendix.

P.1 Baseband coding structure

RDS consists of fixed length groups having 4 blocks each. MMBS is also transmitted in modulo-4 groups of 4 E blocks. MMBS blocks are identical to RDS blocks, each having 16 information bits and 10 check bits with the exception that MMBS uses the $E = 0$ offset word (see section 2.1).

P.2 Synchronization of blocks and groups

All MMBS blocks employ an offset word E consisting of all zeros. MMBS blocks thus do not utilize an offset word, but other receivers must recognize a null offset word to avoid interpreting the MMBS error-protecting syndrome as flawed RDS blocks. The E offset word is thus necessary for maintaining the synchronization of the flywheel (see section 2.4).

P.3 RDS principal features

MMBS blocks do not contain any of the RDS principal features as defined in 3.1.2.

P.4 Group types

The recommended group sequencing for RDS/MMBS multiplexing to maximize MMBS data capacity is shown in Table P.1.

M represents four MMBS blocks and #A represents any RDS group (see section 3.1.3).

E represents EWS channel marker or EWS Waking Activation or Alert.

Table P.1

	1 sec.												2 sec.										
Skeleton structure w/ AF's	0A		0A	3A		0A		0A				1A	0A		0A	3A		0A		0A			1A
Skeleton structure w/o AF's	0B		15A	3A		0B		15A				1A	0B		15A	3A		0B		15A			1A
Normal Run w/ AF's		2A			0A		2A		0A	0A	2A			2A			0A		2A		0A	0A	
Normal Run w/o AF's		2A			15A		2A		15A	15A	2A			2A			15A		2A		15A	15A	
Normal Run w/ AF's w/ PTYN		10A			0A		10A		0A	0A	10A			10A			0A		10A		0A	0A	
Normal Run w/o AF's w/ PTYN		10A			15A		10A		15A	15A	10A			10A			15A		10A		15A	15A	
Every Minute																							4A
Every 12 hours		9A												9A									
Before and After Traffic Message		2A			15B		2A		15B	15B	2A			2A			15B		2A		15B	15B	
Emergency (EWS)		9A			9A		1A		9A	9A	9A			9A			9A		1A		9A	9A	
Paging		2A			7A		2A		7A	7A	7A			2A			7A		2A		7A	7A	
Paging (peak) - all.		7A			7A		7A		7A	7A	7A			7A			7A		7A		7A	7A	
TMC (peak)		2A			8A		2A		8A	8A	8A			2A			8A		2A		8A	8A	
In-house application		2A			6A		2A		6A	6A	6A			2A			6A		2A		6A	6A	
Transparent Data Channel		2A			5A		2A		5A	5A	5A			2A			5A		2A		5A	5A	
RDS + MMBS**	0A	M	15A	0A	M	M	0A	15A	M	M	M	15A	0A	M	15A	0A	M	M	0A	15A	M	M	
RDS + MMBS (peak)**	0A	M	M	M	M	0A	M	M	M	M	M	0A	M	M	M	M	M	0A	M	M	M	M	M
RDS+MMBS+MMBS/ MBS EWS																							E
Group 1A Block 3 Variant Sequencing*																							
TMC	0	1	1	1	1	1																	
EWS	0	7	7	7	7	7																	

*When Group 1A is transmitted, slow labeling codes (as defined in Section 3.2.1.9) located in block 3 will need to be sequenced by variants. These variants contain certain information relating to several RDS options. Thus, the sequencing of the block 3 variant of Group 1A given in the above table are to optimize the data transfer for the specific RDS operations: TMC, EWS, and RDS paging respectively.

**Broadcasters with translators or multiple transmitters who use the multiplexed RDS+MMBS signal may experience slower AF switching due to a reduced repetition rate of the AF information.

P.5 Offset Word to be used for group and block synchronization

MMBS blocks use offset word E of all zeros i.e. $d_9 - d_0 = 0000000000$ (see annex A). Thus the message code vector becomes the transmitted code vector (see section B.1.1). In an error free transmission of an MMBS block the syndrome $\bar{s} = 0000000000$ (see section B.1.2 and Table P.2).

Table P.2

Offset word	Binary Value									
	d_9	d_8	d_7	d_6	d_5	d_4	d_3	d_2	d_1	d_0
A	0	0	1	1	1	1	1	1	0	0
B	0	1	1	0	0	1	1	0	0	0
C	0	1	0	1	1	0	1	0	0	0
C'	1	1	0	1	0	1	0	0	0	0
D	0	1	1	0	1	1	0	1	0	0
E	0	0	0	0	0	0	0	0	0	0

If RDS/MMBS multiplex signaling, block sequence can be A-B, B-C, C-D, D-A or D-E, and E-E or E-A i.e. a modulo-4 number of E blocks can be inserted between RDS groups (between offsets D and A) so a fixed cyclic rhythm of occurrence of the offset words would be A, B, C, D, (4 E blocks), (4 E blocks), A, B, C, etc. The syndromes corresponding to offset words A to E are shown in Table P.3.

Table P.3

Offset	Offset word $d_9, d_8, d_7 \dots d_0$	Syndrome $S_9, S_8, S_7 \dots S_0$
A	0011111100	0101111111
B	0110011000	0000011110
C	0101101000	0100101111
C'	1101010000	1011101100
D	0110110100	1010010111
E	0000000000	0000000000

P.6 Acquisition of group and block synchronization

To acquire group and block synchronization at the receiver (for example when the receiver is first switched on, on tuning to a new station, or after a prolonged signal-fade) the syndrome \bar{s} must be calculated for each received 26-bit sequence. That is, on every data-clock pulse the syndrome of the currently stored 26-bit sequence (with the most recently received data bit at one end and the bit received 26 clock pulses ago at the other) is calculated on every clock pulse. This bit-by-bit check is done continuously until two syndromes corresponding to valid offset words, and in a valid sequence for a group i.e. [A, B, C (or C'), D] (if RDS/MBS multiplex signaling, block sequence can be A-B, B-C, C-D, D-A or D-E, and E-E or E-A i.e. a modulo-4 number of E blocks can be inserted between RDS groups (between offsets D and A) so a fixed cyclic rhythm of occurrence of the offset words would be A, B, C, D, (4 E blocks), (4 E blocks), A, B, C, etc.) are found $n \times 26$ bits apart (where $n = 1, 2, 3$, etc.). When this is achieved, the decoder is synchronized and the offset words which are added to the parity bits at the transmitter are subtracted at the receiver before the syndrome calculation for error correction/detection is done (see C.1.1).

P.6.1 Shift register arrangement for deriving group and block synchronization

There are several methods using either hardware or software techniques for deriving group and block synchronization information. One possible method is described below. Figure P.1 shows a block diagram of a shift-register arrangement for deriving group and block synchronization information from the received data stream. It may be seen to comprise five main elements:

- a) a 26-bit shift-register which may either act as a straight 26-bit delay (A/B input selector high) or as a recirculating shift-register (A/B input selector low);
- b) a polynomial division circuit comprising a 10-bit shift-register with feedback taps appropriate to the generator polynomial, $g(x)$, described in 2.3 and appendix B;
- c) a combinational logic circuit with six outputs indicating the presence of the "correct" syndromes resulting from the six offset words A, B, C, C', D and E (for maintaining synchronization);
- d) a fast-running clock operating at least 33.5 kHz;
- e) a modulo-28 counter with endstops, decoding for states 0, 1 and 27, and associated logic gates 1 to 3 and flip-flops 1 to 3 (FF1 to FF3).

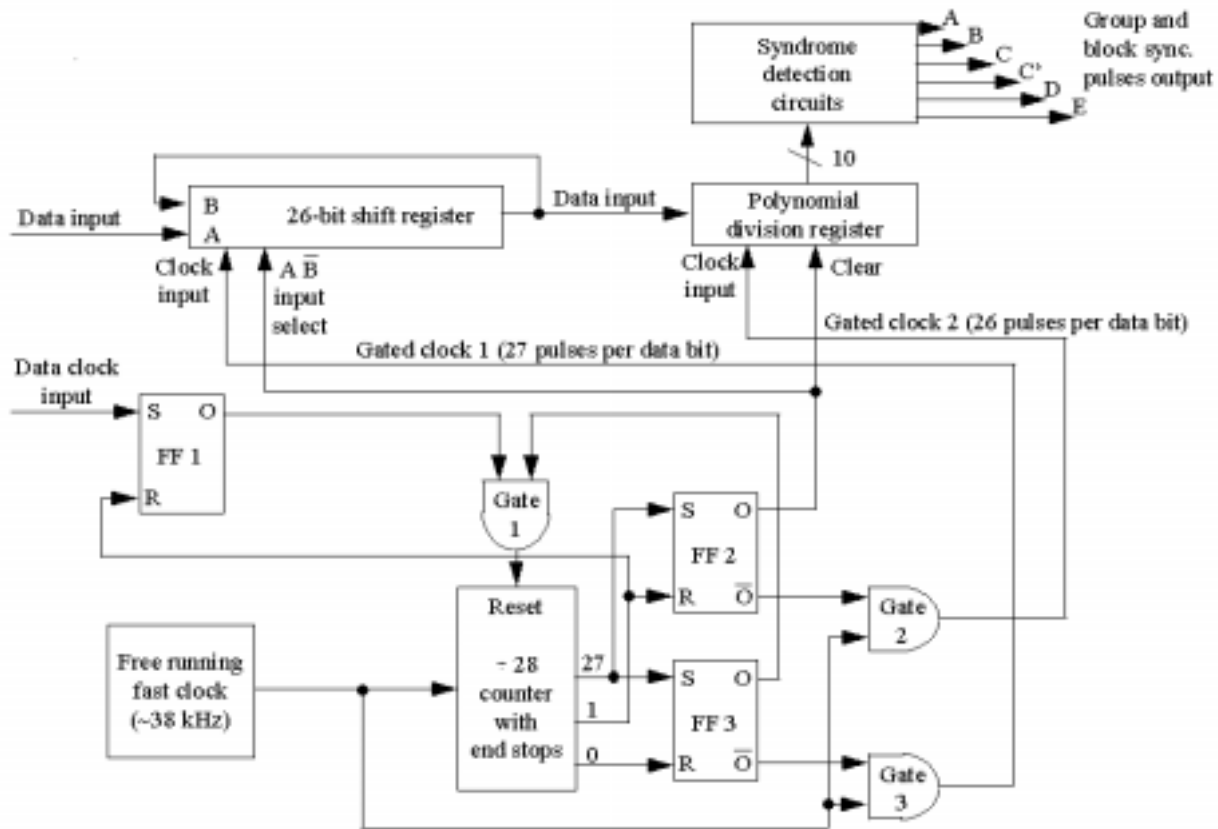

Figure P.1: Group and block synchronization flywheel detection circuit for RDS/MMBS multiplex signals

P.7 MMBS Group Structure

The MBS message is of variable length, ranging from one to eight blocks. The MMBS block is structured identically to the RDS block except that the offset word, E, consists of all zeros. See Figure P.2 - MMBS message. The MMBS group consisting of MMBS blocks is modulo-4 length (i.e. 0,4,8,.. blocks).

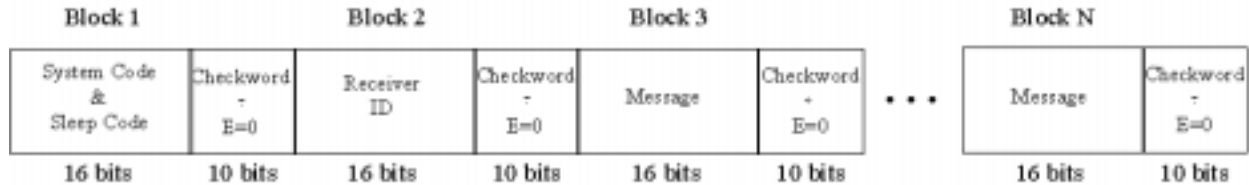

Figure P.2: MMBS message

P.8 RDS/MMBS Multiplex Transmission Sequence

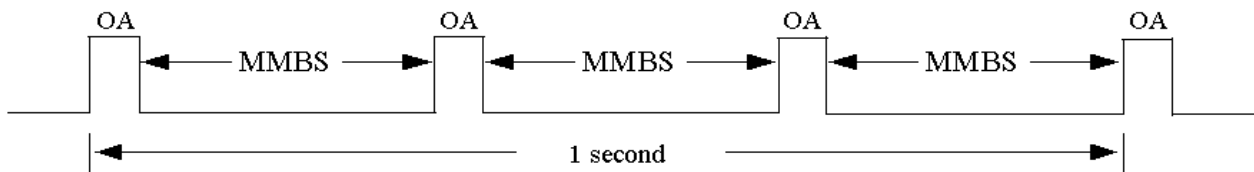

Figure P.3: Typical multiplex coding

- a) At least two OA, OB, 15A, or 15B groups, as appropriate, will be transmitted each second. A 4A group will be transmitted at the start of each minute. Type 2 and 15 groups will be transmitted as required.
- b) The MMBS transmission will consist of variable length MMBS messages assembled to yield MMBS groups formatted to lengths of modulo-4 blocks.
- c) Whenever there are no pages or RDS groups due for transmission, then filler MMBS blocks or additional OA groups will be transmitted.

P.9 MMBS Radio Paging

P.9.1 MMBS Numeric Paging

The current numeric pagers can receive messages of one to 12 decimal digits. These digits are transmitted as hexadecimal characters. Hex character A is used as a filler or spacer in the page. Since the smallest unit of transmission is the 26 bit block with 16 information bits, the telephone number 1234567 would be transmitted as 123A 4567 to provide a space on the display to emulate the normal seven digit telephone number format. The number 12345 would be transmitted as 12345AAA to provide three blank spaces in the 26 bit block dedicated to transmitting the integer 5. As the data right shifts on the display, the lead A's are ignored. The number of blocks included in the page is the minimum necessary to convey the input numeric.

P.9.2 MMBS Alphanumeric Paging

Alphanumeric paging and text transmission generally imply message lengths exceeding five blocks and require stringing multiple MMBS groups into one lengthy message. The alphanumeric message header is shown below. Subsequent groups for the same message will substitute text information in the receiver ID and length blocks.

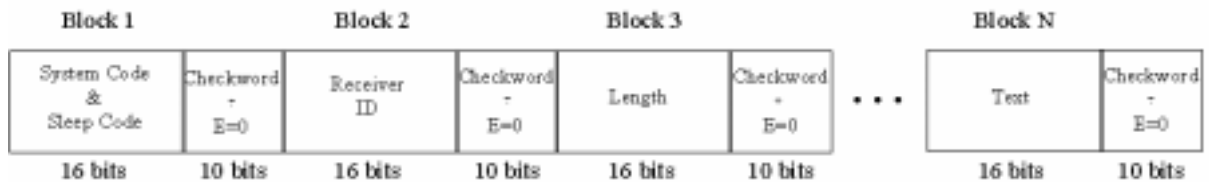

Figure P.4

Although the figure implies a byte oriented coding, it is best to view the transmission as bit oriented in packets of 16 bits. The user can then employ optimized variable length codes to achieve optimal efficiency. In this case, alphanumeric pages and text transmission are transmitted in groups ranging from three to eight blocks in length.

It is essential that the system ID not appear in the first 8 bits of any message block. Violation of this rule could cause a false synchronization of the receiver.

P.10 Battery Saving Transmission Sequence

a) The MMBS pager operates on a battery saving cycle, commonly referred to as a "sleep cycle". The pagers are divided into groups corresponding to the sleep code defined above. The sleep code must appear twice within 12 consecutive blocks to initiate the battery saving power-down of the pager. The power-down occurs 12 blocks after the last occurrence of the pager's sleep code. The pager stays powered-down for 31 seconds and then, on power-up, resynchronizes to the MMBS signal. The resync algorithm will fly-wheel through any 0A, 4A, or other RDS group which may actually be in transmission at that instant.

b) The MMBS paging cycle lasts a minimum of 1494 blocks, during which all existing pager groups are provided their pages, if any, or at least their sleep codes to initiate the power-down process.

P.11 Pager Synchronization

P.11.1 Locking to a Channel

a) The receiver looks for the system ID within an error-free block. It must find at least one additional error free block within the next nine blocks to establish synchronization.

b) When the receiver is in scan mode, it must establish synchronization within one-half (0.5) second. If it does not, it must leave the channel.

c) When powering up from the battery saving mode, it must establish synchronization within fifteen (15) seconds. If it does not, it must leave the channel.

P.11.2 Loss of Synchronization

When 43 of the last 45 blocks have a syndrome different from zero, the receiver will try to achieve resynchronization by the synchronization rule used in channel scan. If it does not resynchronize within fifteen (15) seconds, it must initiate channel scan.

P.12 Data Transmission

P.12.1 Extended Addressing

Data transmission can be carried out by either the numeric or alphanumeric formats described above. In data applications calling for very large numbers of receivers, the capacity of 1 million addresses, per system ID, described in section 3.2.6.2 could be insufficient, depending on other applications in the network. In this situation, one SSSCIII address can be allocated to the date application and then receivers can be uniquely addressed via the next one or two message blocks. Alternately, one system ID SSSC block could be allocated and the next one or two blocks made available for addressing. Since hex characters are employed in the address space, the individual address characters can range from 0 to F, rather than only 0-9. However, it is essential that the system ID not appear in the first 8 bits of any extended addressing or message block. The occurrence of the system code in the first 8 bits would cause a false resynchronization of the receiver.

P.12.2 Synchronization

If the data receiver is a scanning receiver and is kept in a stationary position, then the receiver should use the following rules for declaring synchronization.

- a) The receiver must find the system ID in an error-free block followed by 9 error-free or correctable blocks.
- b) When the receiver is in scan mode, it must establish synchronization within one second. If it does not, it must leave the channel.
- c) When powering up from the battery saving mode, it must establish synchronization within fifteen (15) seconds. If it does not, it must leave the channel.

P.12.3 Loss of Synchronization

When 43 of the last 45 blocks have a syndrome different from zero, the receiver will try to achieve resynchronization by the synchronization rule in a above. If it does not resynchronize within fifteen (15) seconds, it must initiate channel scan.

If the data receiver is a mobile receiver it may use the pager synchronization rules in P.11.1 and P.11.2.

P.13 In-House Applications

These applications can be met by the methods described in section P.12. The MMBS protocol is flexible and efficient in channel utilization.

P.14.0 MBS and MMBS Coding of Emergency Warning Systems (EWS)

There is a need for comprehensive emergency broadcast system information using an MBS or MMBS EWS packet group and codes that will be fully detailed here and made available as a public service. The EWS message will only be broadcast in cases of extreme emergency. The Emergency Warning information is in accordance with the FCC Rules and Regulations Section 11, Subpart B.

The following Identification is required to operate MBS or MMBS EWS.

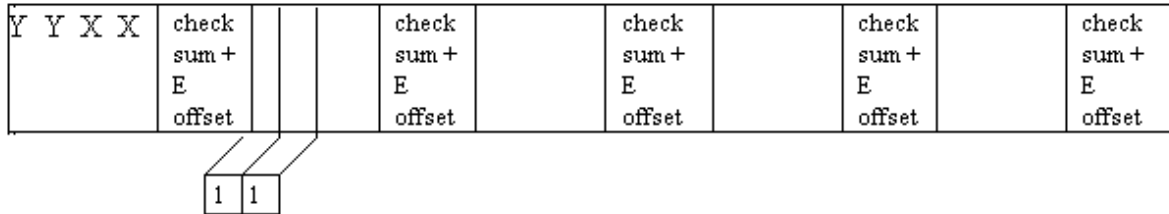

Figure P.5

The system ID of YY, where YY= BO-FF hex and by the group code XX (BCD 00-99) defines an MBS or MMBS system. The System ID of B5 is currently used in North America for EWS messaging.

P.14.1 MBS or MMBS EWS SYNCHRONIZATION

MBS or MMBS Synchronization occurs with recognition of the proper system ID and offset word E (see section P.2). For purposes of EWS identification the MBS and MMBS EWS messages have the bits in block 2, positions 15 and 14 fixed at 1 and 1. These bits will only be fixed in this way on a channel that will carry the Auxiliary Services which also include EWS messages.

P.14.2 MBS or MMBS EWS Format: Block 2 description

Figure P.6 shows the format of Block 2

P.14.2.1 Auxiliary Services

The Auxiliary Service bits in position 15 and 14 of block 2 are fixed at 1 and 1. These two bits along with the system ID in the first two nibbles of block one, are used to define the channel as an Auxiliary Channel. Included within Auxiliary Services are MBS or MMBS EWS messages when needed.

P.14.2.2 Message Status

The message status bit in position 13 is used to designate the message as a service message or a test message. Test messages are only intended for receivers used to test the integrity of the system and not for the general public.

P.14.2.3 Sub ID

The sub ID in bits 12-8 are used to identify different Auxiliary Services. During EWS alerts, these bits will be fixed to 0 0 1 0 1 .

P.14.2.4 Group Type Identification

The group type identification bit in position 7 is used to set the group type of the message.

- 0 = EWS type message
- 1 = Traffic

P.14.2.5 Character type

The character type bit used in position 6 will identify the type of characters used in the description of the emergency warning message.

- 0= ASCII characters
- 1= Translation Table

P.14.2.5.1 ASCII Table Character Type

Groups contain an ASCII character message if the character bit (bit 7) in block 2 is set to 0. The ASCII messages will occupy bits 0-6 and 8-14 of the designated ASCII blocks within ASCII groups. (See Figures P.7 & P.9)

The ASCII character is assumed to have the 8th bit (b8) fixed at 0 and not transmitted thus utilizing the 96 characters in the leftmost portion of the chart described in Appendix E, Figure E.1

P.14.2.5.2 Translation Table Character Type

Groups contain Translation Table messages if the character bit (bit 7) in block 2 is set to 1. The translation messages and tables are comprised of the information as described in the FCC Rules and Regulations, Part 11, Subpart B, Section 11.31 EAS Protocol. There are three or more MBS or MMBS groups for each translation table message

See Figures P.8, P.10 & P.11 for a description of Translation Table Character Type messages.

P.14.2.6 Status Identification

The service identification bits in positions 5-3 of block 2 are used to indicate the status of the message.

- 000 = Public Service EWS channel marker.
- 001 = Public Service EWS Waking Activation
- 010 = Public Service EWS Alert
- 011 = Audio message on frequency in block 3. Turn on audio
- 100 = No audio message, turn off audio
- 101 - 111 unassigned

Waking Activation will be transmitted in accordance with the attention signal requirements (FCC Rules and Regulations, Part 11, Subpart B, Section 11.32 Encoder) of not less than 8 nor longer than 25 seconds prior to an alert.

The EWS Group Type message will terminate at the end of block 2 if the Status Identification address equals 000, 001 or 100 and will terminate at the end of block 3 if the Status Identification address equals 011.

P.14.2.7 Message Identification

The message identification bits in positions 0-2 are used to keep the particular warning or message identified with the content of that particular message. This binary address will cycle through from 000 to 111 to designate the incident or story being transmitted. This ID used with the sequence number in block 3 of the message will identify the message in its original order in case of a message group that is out of group order or is held in the encoder queue for an additional paging cycle. The ID will cycle through in binary order.

MBS or MMBS EWS Format: Block 2

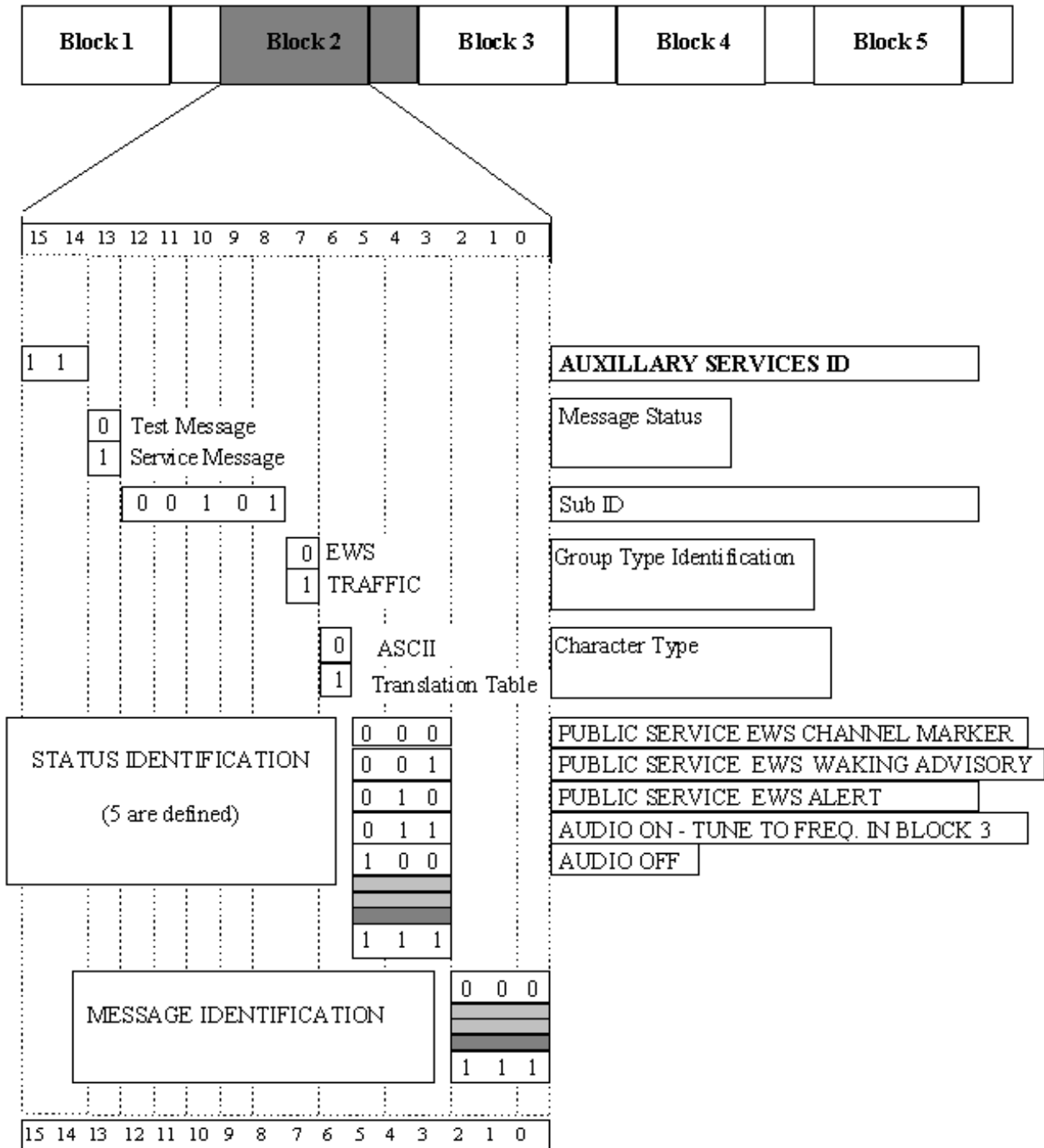

Figure P.6

P.14.3 MBS or MMBS EWS Format: Block 3 description

P.14.3.1 ASCII Table Character Type Message

See section P.14.2.5.1 for a description of the ASCII characters.

Figure P.7 shows the format of MMBS or MBS EWS Block 3 for ASCII Table Character Type messages.

P.14.3.1.1 ASCII Table Character Type Sequence Number

The sequence number is a binary number in positions 14-8 of block 3. The numbers are used to designate several possibilities about its group. Bits 15 & 7 are not used and is set to 0 in the encoder.

In ASCII table character type messages, the sequence numbers can be used for a possibility of 126 pages per messages.

The address 1111101 identifies the last group in the message no matter where in the binary sequence it appears. The last group of the message can be 3-5 blocks in length. The last group will terminate at the last bit of information block 3, 4 or 5, if a B5 system identifier or an RDS group is present.

The address 1111110 defines a message as a header group only. The message will be contained within a single page, 3-5 blocks in length.

P.14.3.1.2 Tuning Frequency

The frequency of the station to tune to for audio information when the Audio On Status Identification code is in block 2 is represented by bits 7 through 0 in the first group of ASCII table character type messages. This is an 8 bit lookup table described in 3.2.1.6 coding of alternative frequencies (AF's) in group 0A. It is intended to identify the originating frequency of the EWS message

P.14.3.1.3 ASCII characters

Bits 7 through 0 of block 3 in all groups of ASCII table character type messages after the first group will represent an ASCII character. See section P.14.2.5.1 for a description of the ASCII character translation.

P.14.3.2 Translation Table Character Type Message

See section P.14.2.5.2 for a description of Translation Table characters.

Figure P.8 shows the format of MBS or MMBS EWS Block 3 for Translation Table Character Type messages Group 1, Group 2, and Groups 3-33.

P.14.3.2.1 Block 3, Group 1

P.14.3.2.1.1 Sequence Number

The sequence number for block 3, group 1 of the translation table character type message is 0000000 (header group). See P.14.3.1.1.

P.14.3.2.1.2 Tuning Frequency

The frequency of the station to tune to for audio information when the Audio On Status Identification code is in block 2 is represented by bits 7 through 0 in the first group of translation table type messages. This is an 8 bit lookup table described in 3.2.1.6 coding of alternative frequencies (AF's) in group 0A. It is intended to identify the originating frequency of the EWS message

P.14.3.2.2 Block 3, Group 2

P.14.3.2.2.1 Sequence Number

The sequence number for block 3, group 2 is 00000001. See P.14.3.1.1.

P.14.3.2.2.2 Duration - Minutes

Block 3, bits 7 and 6 in group 2 of the translation table message is the duration in minutes. This field is used in conjunction with duration in hours to designate addition time in 15 minute segments to be added to the value of duration hours.

00 = 00 minutes

01 = 15 minutes

10 = 30 minutes

11 = 45 minutes

P.14.3.2.2.3 Message Date Stamp - Julian Date

Bits 5 through 0 of block 3, group 2 are the first of 9 bits used to represent in binary the day in Julian Calendar days of the year when the EWS message was initially released by the originator. The remaining 3 bits are in block 4, group 2. See section P.14.4.2.2.1.

P.14.3.2.3 Block 3, Groups 3-33

P.14.3.2.3.1 Sequence Number

The sequence number for block 3, group 3 is 00000010 and for the following groups increments by one until the last group. The sequence number for the last group is always 1111101.

P.14.3.2.3.2 County Subdivision Number

Bits 6 through 0 of block 3 in groups 3 through 32 will contain the ASCII character which represents the county subdivision of the geographic location affected by the EWS alert. See section P.14.2.5.1 for a description of the ASCII character translation.

MBS or MMBS EWS Format: Block 3, ASCII CHARACTER TYPE MESSAGE

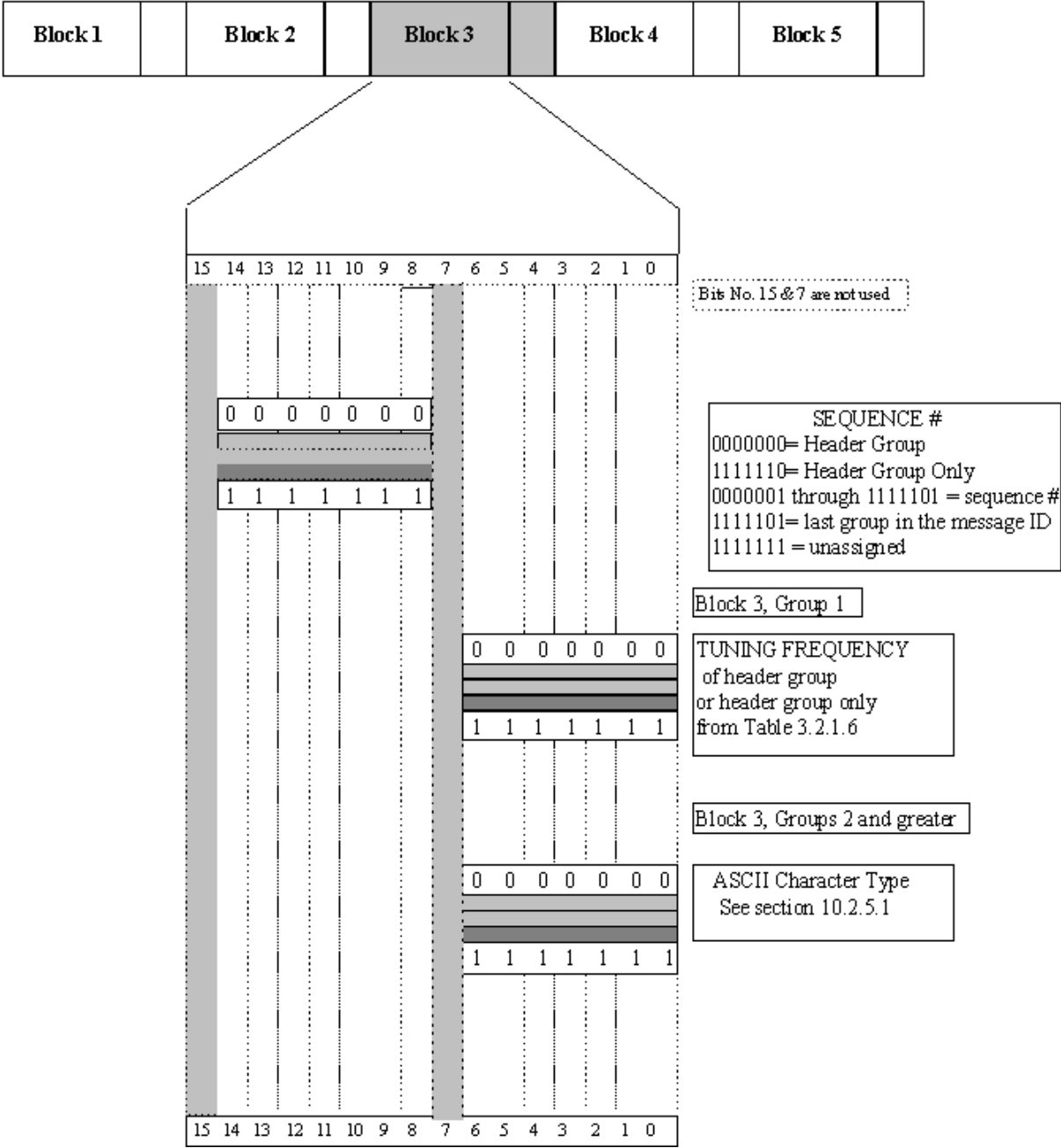

Figure P.7

MBS or MMBS EWS Format: Block 3, TRANSLATION TABLE CHARACTER TYPE MESSAGE

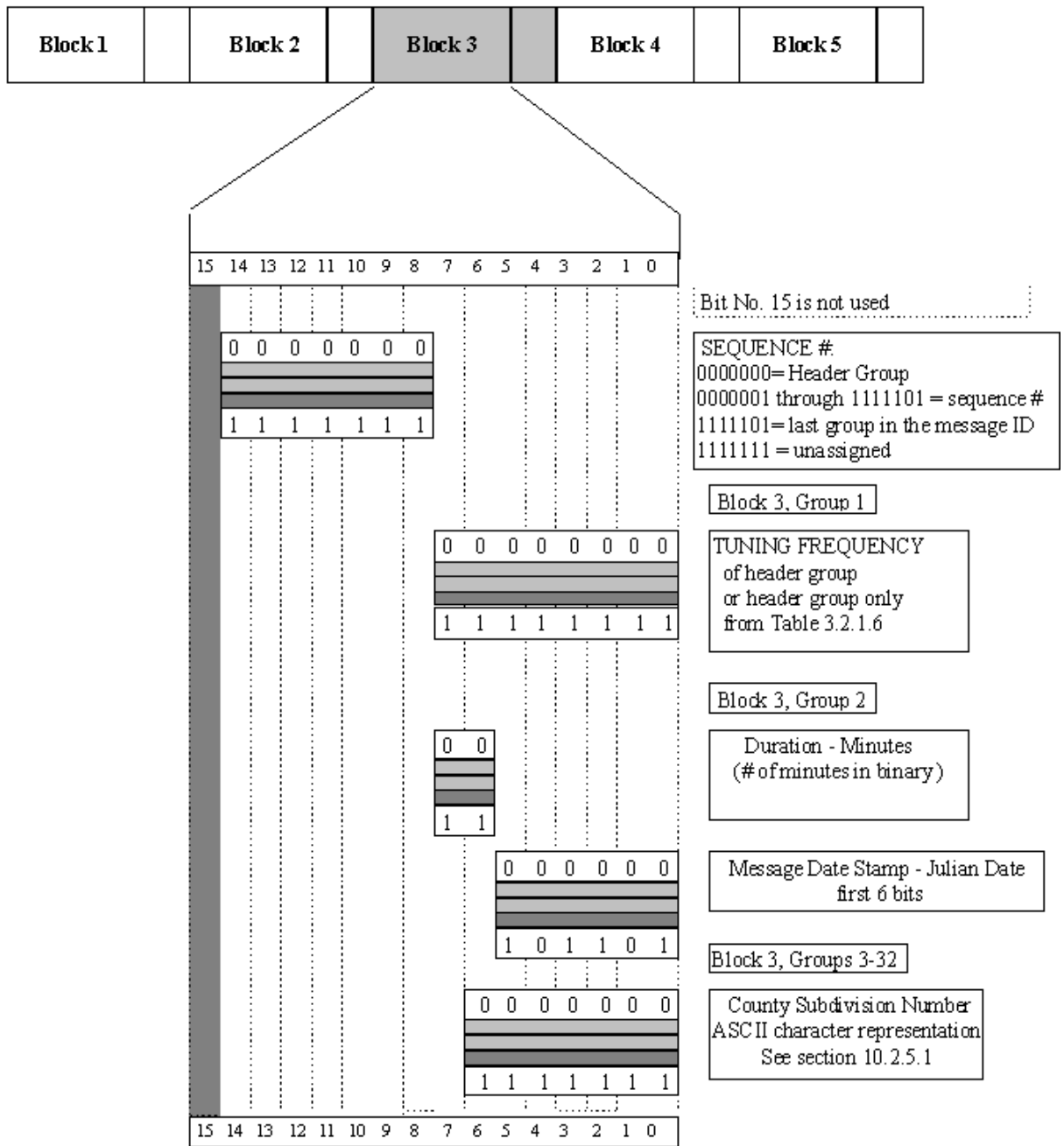

Figure P.8

P.14.4 MMBS or MBS EWS Block 4 description

P.14.4.1 ASCII Table Character Type

See section P.14.2.5.1 for a description of ASCII Characters.

Figure P.9 shows the format of MBS or MMBS EWS Block 4 for ASCII Table Character Type Messages.

See Figure P.9 for a description of ASCII table character type messages.

P.14.4.2 Translation Table Character Type

See section P.14.2.5.2 for a description of Translation Table Characters.

Figure P.10 shows the format of MBS or MMBS EWS block 4 for translation table character type messages.

P.14.4.2.1 Block 4, Group 1

P.14.4.2.1.1 Originator Code

The bits in position 14-12 of block 4 are used to designate the originator of the message according to Table P.4

P.14.4.2.1.2 Event Code

The bits in position 11-5 are the first ASCII character (E1) which makes up the three character event code which indicates the nature of the EWS activation. See section P.14.2.5.1 for description of ASCII character translation. The bits in positions 4-0 are the first 5 bits of the second character of the event code (E2). The last 2 bits of the second character are in block 5 bits 14 and 13. See section P.14.5.2.1.1.

P.14.4.2.2 Block 4, Group 2

P.14.4.2.2.1 Message Date Stamp

Bits 14-12 of block 4, group 2 are the last 3 bits of 9 which are used to represent in binary the day in Julian Calendar days of the year when the EWS message was initially released by the originator. The first 6 bits are in block 3, group 2 bits 5-0. See section P.14.3.2.2.3.

P.14.4.2.2.2 Message Time Stamp, Hours

The Message Time Stamp, Hour field in bits 11-7 is the binary representation of 24 hour time from 0-23.

P.14.4.2.2.3 Message Time Stamp, Minutes

The Message Time Stamp, Minutes field in bits 6-1 is the binary representation of the minutes past the hour from 0-59 and is used with the Time Stamp in hours to set the time of origination of the message. Bit 0 of block 4, group 2 is unused.

P.14.4.2.3 Block 4, Group 3-32

P.14.4.2.3.1 State and Territory Code

Bits 14-8 and bits 6-0 of block 4 in groups 3 through 32 will contain the ASCII character which represents the state and territory code of the geographic location affected by the EWS alert. See section P.14.2.5.1 for a description of the ASCII character translation.

MMBS or MBS EWS Format Blocks 4 and 5: ASCII TABLE CHARACTER TYPE MESSAGE

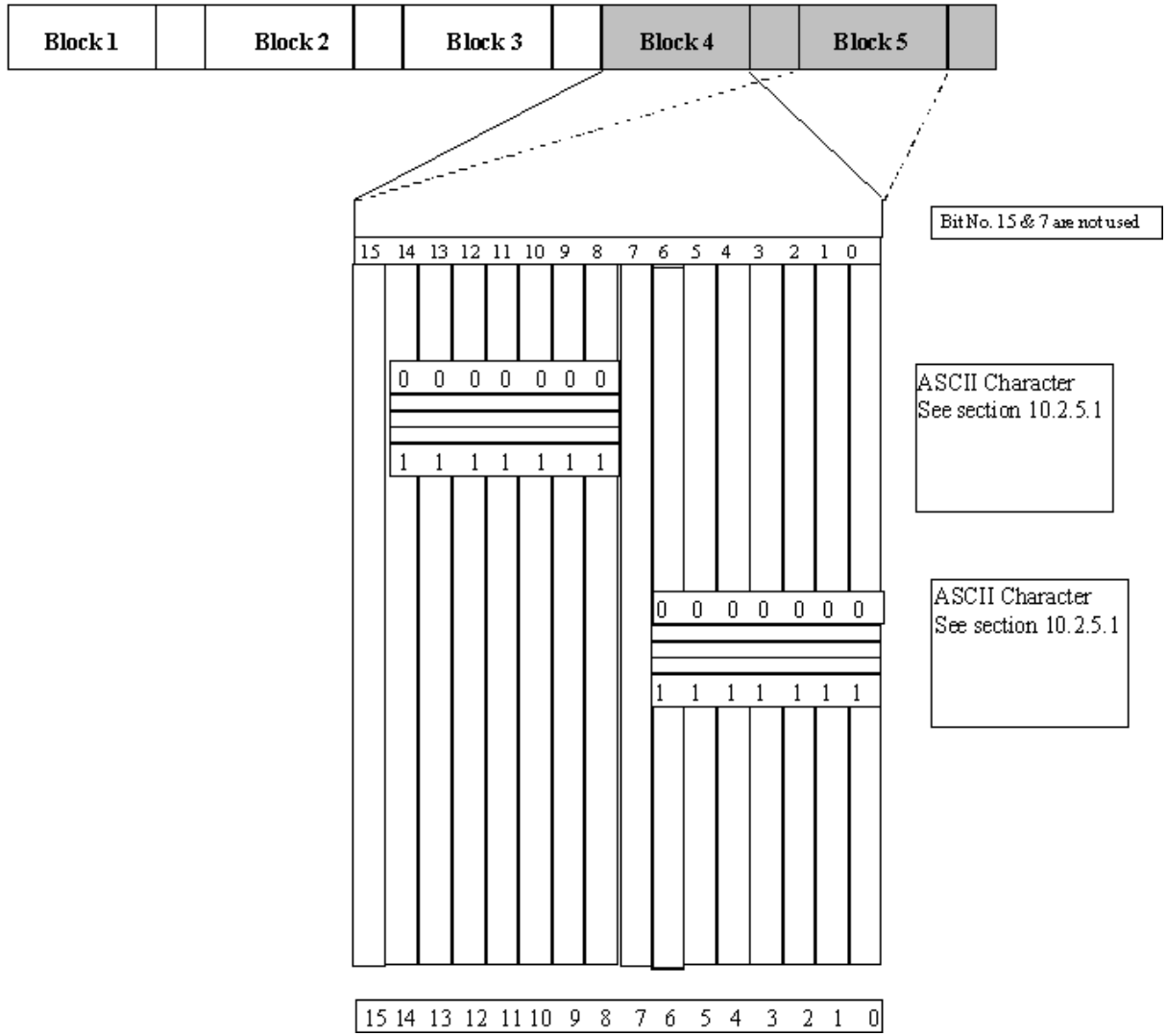

Figure P.9

P.14.5 MMBS or MBS EWS BLOCK 5 description

P.14.5.1 ASCII Table Character Type

See section P.14.2.5 for a description of the ASCII characters

Figure P.9 shows the format of MBS or MMBS EWS block Five for ASCII table character type messages.

P.14.5.2 Translation Table Character Type

See section P.14.2.5 for a description of Translation Table characters.

Figure P.10 shows the format of MBS or MMBS EWS Block 5 for translation table character type messages. In translation table messages, there is no block 5 in group 2.

P.14.5.2.1 Block 5, Group 1

P.14.5.2.1.1 Event Code

The bits in position 14 and 13 are the last 2 bits of the second ASCII character (E2) which makes up the three character event code which indicates the nature of the EWS activation. See section P.14.2.5.1 for description of ASCII character translation. The bits in positions 12-6 are the third and last character (E3) of the event code.

P.14.5.2.1.2 Duration - Hours

The duration in hours is a binary description of the valid time period of the message (warning). Duration can be 0 - 64 hours.

Binary representation in hours

000000 = 0 hours

000001 = 1 hour

: : : : : : : : : :

111111 = 64 hours

P.14.5.2.2 Block 5, Group 2

P.14.5.2.2.1 Location Count

There may be up to 31 geographic locations affected by the EWS alert sent with each EWS message. Bits 14-10 of block 5, group 2 represent the number in binary of geographic locations to be sent with this EWS message. The geographic locations are transmitted in groups 3-33.

P.14.5.2.3 Block 5, Groups 3-33

P.14.5.2.3.1 County Number

Bits 14-10 of block 5, groups 3-33 represent the county number of the geographic location affected by the EWS alert.

MMBS or MBS EWS Format: Block 5, TRANSLATION TABLE MESSAGE GROUP 1

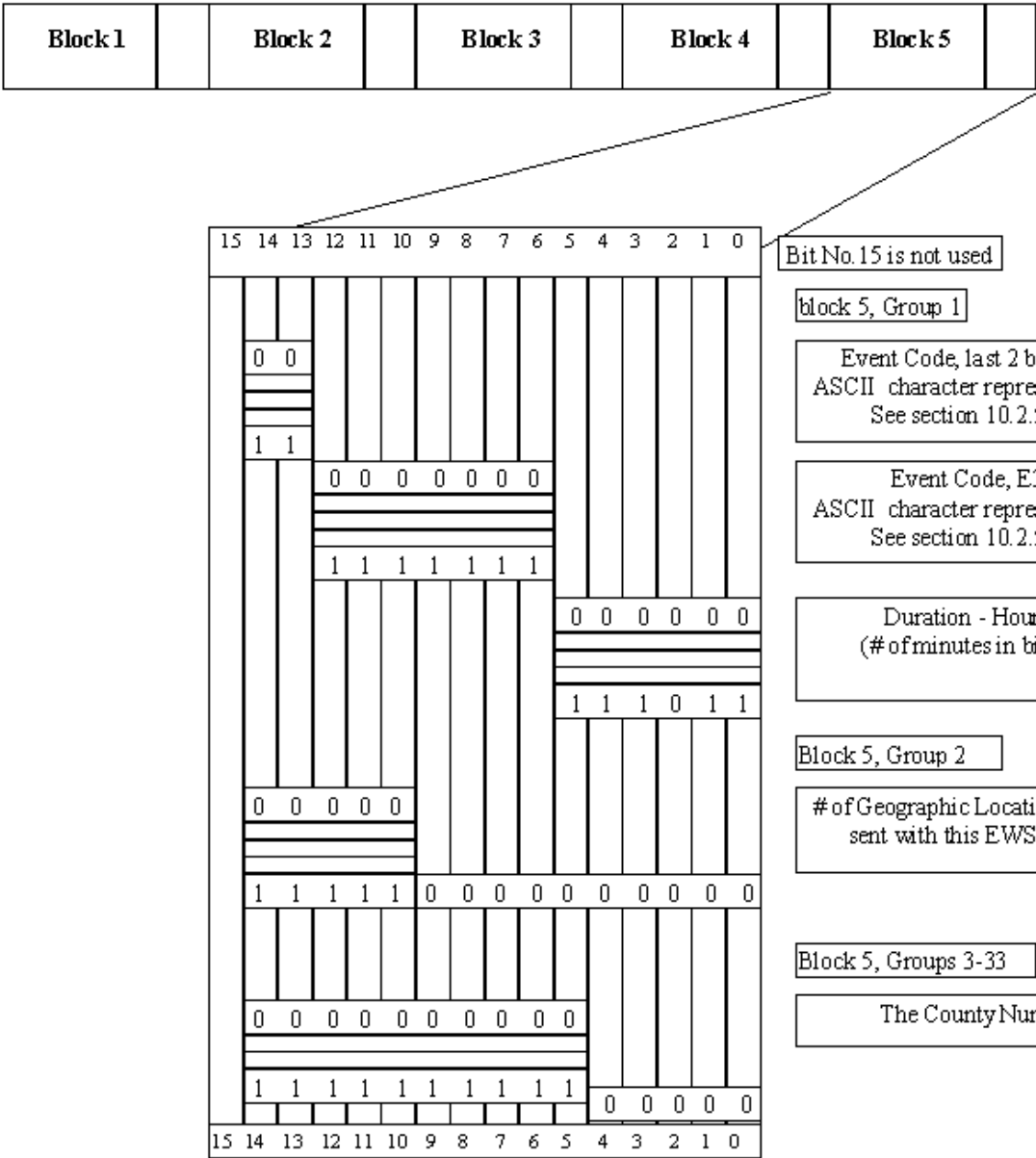

Figure P.11

Originator Field
 Table P.4

MMBS EWS	Description (Translation)	SAME Code
000	Emergency Action Notification Network	EAN
001	Primary Entry Point System	PEP
010	National Weather Service	WXR
011	Civil Authorities	CIV
100	Broadcast or cable station	EAS
101	unassigned	unassigned
:::	: : : : :	: : : : :
111	unassigned	unassigned

Table P.6 Translation Characters for State and Territory field

State	ASCII Code
AL	01
AK	02
AZ	04
AR	05
CA	06
CO	08
CT	09
DE	10
FL	12
GA	13
HI	15
ID	16
IL	17
IN	18
IA	19
KS	20
KY	21
LA	22
ME	23
MD	24
MA	25
MI	26
MN	27
MS	28
MO	29
MT	30
NE	31
NV	32
NH	33
NJ	34
NM	35
NY	36
NC	37

State	ASCII Code
ND	38
OH	39
OK	40
OR	41
PA	42
RI	44
SC	45
SD	46
TN	47
TX	48
UT	49
VT	50
VA	51
WA	53
WV	54
WI	55
WY	56
DC	11
AS	60
PR	72
FM	64
PW	70
GU	66
UM	74
MH	68
VI	78
MP	69
future	
: : :	
future	

ANNEX Q (normative)

Emergency Alert System Open Data Application

Q.1 Introduction

This annex describes the use of the Open Data Application (ODA) for transmission of Emergency Alert System (EAS) data. A detailed description of the EAS protocol is given in 47 CFR Section 11 of the Federal Communications Commission (FCC) Rules and Regulations. This system has been designed to augment, rather than replace existing RDS features related to emergency warning. The protocol contained in this annex is public information and is free for use by any person(s) or company(s). The system is designed to allow additional private emergency services.

Q.2 Alternate Warning Systems

Emergency information may be obtained in a number of ways. While the EAS ODA protocol is designed to address specific problems, receiver manufacturers should note that emergency data can also be obtained in the following ways:

1. Group 1A address code 7 - The reception of this group type indicates that the broadcaster carries EAS transmissions. Emergency announcements will be signaled by PTY=31. Other RDS features such as radiotext may also provide emergency information.

NOTE: Section 3.1.4.1 specifically states that group 9A may not be utilized for ODA when used for EWS. This means that this EAS ODA cannot be used on the same transmission system that carries EWS information via group 1A address code 7 and/or group 9A.

2. Via the MBS/MMBS system - See annex P for details.

Q.3 System Description

The EAS ODA functions as a link in the EAS web. The entire SAME data protocol (less preamble and headers) is retransmitted within the RDS signal. This signal can then be received and decoded, allowing the reconstruction of the entire EAS message, which then can be relayed on, or displayed on a specialized receiver. The intention is that SAME data will not be decoded by consumer receivers due to the additional software capacity required. The EAS encoder should provide the SAME data translations and transmit this converted data through traditional RDS features such as radiotext. Broadcast audio announcements intended for the general public should be signaled through PTY code 31.

Q.3.1 Use of existing RDS Features

The following existing RDS features are utilized with the open protocol:

1. PTY-30 "Test" - Indicates that a test transmission is in process. No interruption of the audio should occur during the reception of this code. Received data will be handled as test data and not valid warning data.
2. PTY-31 "Alert" - Indicates that an emergency alert is in process. An audio warning message will accompany this code. Consumer equipment should interrupt current operations (i.e. playback or radio off) during the reception of this code and switch over to FM reception. Receivers should increase the volume to a audible level during the reception of this code.
3. Radiotext (Group type 2A/B) - Broadcast EAS equipment should decode and reconstruct EAS messages into this format for reception by consumer receivers. This prevents the necessity for having SAME data conversion software in each consumer receiver.

Q.3.2 New Features of the EAS Open Protocol

The following new features are available by the use of this open protocol:

1. The identification of an EAS broadcast station - Reception of the proper AID code indicates that the currently tuned station provides EAS data in accordance with this protocol. This data is transmitted once per second minimum, thus allowing automated search tuning.
2. Operation of a sleep/wake cycle for battery powered equipment - The Warning Activation (WA) bit will be set prior to the transmission of any test or alert data, allowing receivers to “wake” upon the reception of WA=1. In this manner a receiver may “sleep” for 9 seconds, and “wake” long enough to receive the WA bit, thus greatly conserving battery power.
3. Identification of alternate EAS providers - Secondary EAS providers may be identified through this feature for storage in the receiver. This allows instant tuning to an alternate frequency should the currently tuned station go off the air during an alert message. This feature also allows automatic tracking of EAS stations by a mobile receiver. The EAS Other Network (ON) data shall be kept separate from other AF information since the stations audio broadcast will not be coordinated except during an actual Alert situation.
4. Instant tuning to alternate EAS broadcasts - The broadcaster can automatically retune the listener to an alternate network who is carrying Alert information. The broadcasts must be coordinated such that the PTY of the other network is set to 31 within two seconds after the switching data is transmitted.
5. FCC EAS Compatible - The EAS open protocol includes the retransmission of all SAME data. This data can be serve as a secondary link in the EAS service “web”. In this manner EAS data can be carried silently by FM broadcasters.
6. Provision for private or encrypted Emergency Services - Companies who desire to carry encrypted emergency data may do so by applying for a System Identification code through the NRSC. Spare data fields contained in the 3A and 9A groups may be utilized to carry this data. Transmission of SAME data must be given priority within the system.
7. Error reduction of SAME data - The SAME data may be transmitted multiple times allowing the use of time diversity to ensure accurate message delivery. In fact, the SAME data may be transmitted constantly for the duration of the event. Traditional RDS error detection/correction may also be employed to ensure data integrity.

Q.4 System Identification

Reception of AID code “E911” identifies the EAS open data protocol as indicated in Figure Q.1. The system identification code is used only by specialized receivers intended to decode encrypted data. Independent broadcasts are identified by the system identification code set to all 0’s.

Q.5 Repetition rates

Q.5.1 Group 3A

The EAS open data identification information should be transmitted at least once per second. This allows receivers to employ automatic search tuning for EAS stations.

Q.5.2 Group 9A Address code 30

EAS Other Network (ON) references shall be transmitted within a two minute period.

Q.5.3 Group 9A Address code 31

Automated EAS ON switching information should be repeated four times.

Q.6 Sleep wake operation

The Warning Activation (WA) bit of group 3A will be set to 0 during non-Alert conditions. This bit shall be set to 1 ten seconds prior to the beginning of any of the following conditions:

1. PTY=30, Test.
2. PTY=31, Alert.
3. The transmission of any SAME data message.

The transmission of any encrypted data message. The WA bit shall remain set to 1 throughout the duration of any of the above events. If this bit is set, then the receiver should remain awake and wait for the desired data. For example, a consumer receiver should check the status of the PTY before taking any further action.

Q.7 Private Warning Systems

Q.7.1 Warning System Identification (WSI)

Warning System Identification bits b_0 - b_6 located in Group 3A are utilized for encrypted services. Assignments may be obtained from the NRSC. The provider may utilize any of the unassigned data bits in the 3A and 9A data groups for private data services. Public providers are identified by WSI = 0. Priority shall be given to the transmission of public warning data over encrypted data.

Q.7.2 Private Warning Data

Private warning data may be supplied through the following groups:

1. Bits b_7 - b_{14} of Group 3A
2. Group 9A Address codes 5 - 29 Block 3 and 4 data fields.

Private warning data may not be supplied through any of the predefined data fields, including fields labeled as spare.

Q.8 Coding of SAME data

All SAME data shall be converted in accordance to Tables Q.1 - Q.3. The encoded data is then transmitted within Group 9A in accordance with Figure Q.2.

Q.9 Identification of Alternate EAS Stations

Secondary EAS providers, also known as EAS Other Network (ON) providers, may be referenced through address code 30 of Group 9A as shown in Figure Q.2. For normal network based stations AF information is transmitted in group Type 0A. It can be assumed that all transmitters in a network will carry the EAS service as well. The EAS infrastructure of primary and secondary providers is however non-network based, hence another means of obtaining alternate EAS broadcasts is required. Since EAS AF's will only be used during an actual ALERT or when automatically tracking EAS providers while mobile, EAS ON information must be differentiated within the receiver from network based AF records. The EAS ON AF lists provide the capability to link stations of differing PI codes that form an EAS network. Alternate frequencies are coded in accordance with section 3.2.1.6 . The repetition rate of this information shall be sufficient that all references are given within a two minute time period.

Q.10 Automatic Switching to EAS Other Network Providers

Group 9A Address code 31 (Figure Q.2) - This group is analogous to the operation of the 14B group used during EON Traffic Announcements. Reception of this group indicates that the receiver shall retune immediately to the indicated EAS ON. The PI code of the EAS ON will point to memory locations received via group 9A Address code 30. The following data should be verified during a switch to an EAS ON:

1. The PI code matches that received via group 9A Address code 31.
2. The status of the PTY code. The receiver should wait for two seconds for the PTY code of the EAS ON network to be set to 31. If after two seconds and the PTY<>31, then the receiver should retune to the original network.
3. The end of the emergency announcement will be noted by PTY<>31. The receiver shall then tune back to the originally tuned network.
4. If the signal level or data quality drops below an acceptable level during the event, the receiver shall attempt to tune to an alternate EAS frequency. If no acceptable EAS alternate frequencies are available, then the receiver shall tune back to the original network.

Q.11 PTY code 30 -Test

A PTY code 30 shall be signaled during test transmissions. The reception of PTY code 30 will be signaled visually only on consumer receivers. On an eight character display, the PS name shall be replaced with "Test". On sixteen character or larger displays, the PTY portion of the display shall be changed to "Test" or "Emergency Test". No interruption of the audio or playback devices shall occur. Test transmissions may be data only in nature. For instance, during the transmission of an EAS test message, the PTY code should be set to 30. It may be useful to "trap" a TEST event to ensure system confidence. Such operation is common in NOAA weather band receivers with tone alert decoders.

Q.12 PTY code 31 - Alert

The reception of PTY code 31 indicates that an audible emergency announcement is being given by the broadcaster. A received PTY 31 shall interrupt the consumer audio and playback devices and switch to the FM audio for the event duration. Default minimum audio settings should be used to ensure the audio is discernible to the listener. On an eight character display, the PS name shall be replaced with "ALERT!". On sixteen character or larger displays, the PTY portion of the display shall be changed to "ALERT!". Receivers which have the ability to record and play back audio (such as TA) could capture ALERT audio information. This would be of benefit to someone who stepped out of the car for instance, and missed the ALERT announcement.

Q.13 Radiotext Reception

Receivers that can decode and display radiotext information contained in group Type 2A/2B should allow the user to access the text display during an ALERT condition. EAS equipment shall decode and re-transmit SAME data via radiotext. The following considerations should apply to the transmission of radiotext during an ALERT:

1. Re-transmitted SAME data should be structured in a clear concise manner. Retransmission of EAS codes directly will be of no use to the consumer. A usable message be for example is: "Tornado Warning Hendricks County Until 8:15 PM."
2. Text messages longer than 64 characters in length should be divided into separate individually meaningful messages and should be transmitted for at least 30 seconds. An increase of text repetition during this time would also help ensure proper reception of the message.
3. General rules for text transmission should be followed, such as the toggling of the A/B flag between different messages, as well as not transmitting segment addresses containing all "blanks".

ALERT information transmitted in radiotext could be transmitted for the duration of the event so that listeners who tune to the station after the audio message can still obtain the important information. This would also be helpful for the hearing impaired.

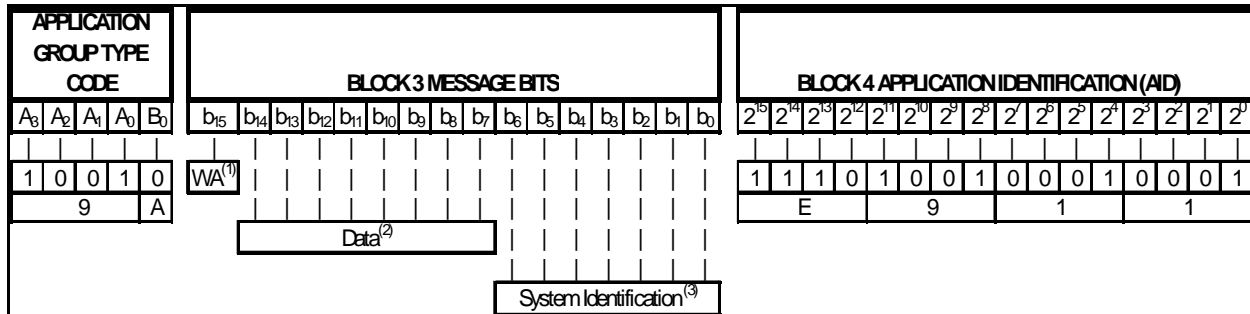

Figure Q.1: EAS Open Data Application Structure - Group type 3A

Note:

- 1) Warning Activation - Can be used by portable receivers operating on a sleep/wake cycle.
 - a) WA set to 0 when no EAS message to follow or end of message.
 - b) WA set to 1 ten seconds prior to setting PTY=30, 31, or SAME message.
- 2) Data bits may be utilized freely by the service provider.
- 3) System Identification.
 - a) All bits set to 0 indicate an independent EAS system.
 - b) Private Warning System Identification assignments are available from the NRSC.
- 4) The recommended repetition rate is at least once per second.

ON - Other network or station

BLOCK 2 DATA BITS (Address Code)	BLOCK 3 DATA BITS															BLOCK 4 DATA BITS																				
0 0 0 0 0	Spares					ORG				Event Character 1(Left-most)						Event Character 2						Event Character 3														
0	0	0	0	0	0	O ₃	O ₂	O ₁	O ₀	b ₈	b ₇	b ₆	b ₅	b ₄	b ₃	b ₂	b ₁	b ₈	b ₇	b ₆	b ₅	b ₄	b ₃	b ₂	b ₁	b ₈	b ₇	b ₆	b ₅	b ₄	b ₃	b ₂	b ₁			
0 0 0 0 1	PSSCCC Count					Portion Code						State FIPS Number						County FIPS Number																		
1	2 ⁶	2 ⁵	2 ⁴	2 ³	2 ²	2 ¹	2 ⁰	b ₈	b ₇	b ₆	b ₅	b ₄	b ₃	b ₂	b ₁	2 ⁶	2 ⁵	2 ⁴	2 ³	2 ²	2 ¹	2 ⁰	2 ⁶	2 ⁵	2 ⁴	2 ³	2 ²	2 ¹	2 ⁰	2 ⁶	2 ⁵	2 ⁴	2 ³	2 ²	2 ¹	2 ⁰
	Event Duration					Message Origination																														
0 0 0 1 0	Hours			Minutes		Julian Date						Hours			Minutes			Spares																		
2	2 ⁶	2 ⁵	2 ⁴	2 ³	2 ²	2 ¹	2 ⁰	Tm ₄	Tm ₃	Tm ₂	Tm ₁	Tm ₀	2 ⁸	2 ⁷	2 ⁶	2 ⁵	2 ⁴	2 ³	2 ²	2 ¹	2 ⁰	2 ⁴	2 ³	2 ²	2 ¹	2 ⁰	2 ⁵	2 ⁴	2 ³	2 ²	2 ¹	2 ⁰	0	0	0	
0 0 0 1 1	ID Character 1(Left-most)					ID Character 2					ID Character 3					ID Character 4																				
3	b ₈	b ₇	b ₆	b ₅	b ₄	b ₃	b ₂	b ₁	b ₈	b ₇	b ₆	b ₅	b ₄	b ₃	b ₂	b ₁	b ₈	b ₇	b ₆	b ₅	b ₄	b ₃	b ₂	b ₁	b ₈	b ₇	b ₆	b ₅	b ₄	b ₃	b ₂	b ₁				
0 0 1 0 0	ID Character 5					ID Character 6					ID Character 7					ID Character 8																				
4	b ₈	b ₇	b ₆	b ₅	b ₄	b ₃	b ₂	b ₁	b ₈	b ₇	b ₆	b ₅	b ₄	b ₃	b ₂	b ₁	b ₈	b ₇	b ₆	b ₅	b ₄	b ₃	b ₂	b ₁	b ₈	b ₇	b ₆	b ₅	b ₄	b ₃	b ₂	b ₁				
5-29	Data ⁽¹⁾															Data ⁽¹⁾																				
1 1 1 1 0	Alternate Frequency (ON)					Alternate Frequency (ON)					PI EAS (ON)																									
30 ⁽²⁾	a ₇	a ₆	a ₅	a ₄	a ₃	a ₂	a ₁	a ₀	a ₇	a ₆	a ₅	a ₄	a ₃	a ₂	a ₁	a ₀	Nibble 1	Nibble 2	Nibble 3	Nibble 4																
1 1 1 1 1	PI EAS (ON)										PI EAS (ON)																									
31 ⁽³⁾	Nibble 1	Nibble 2	Nibble 3	Nibble 4	Nibble 1	Nibble 2	Nibble 3	Nibble 4																												

Figure Q.2: EAS ODA Coding Structure - Group type 9A

Note:

- 1) Data bits may be utilized freely by the service provider.
- 2) EAS Other Network Information - Address code 30
 - a) All EAS ON Alternate frequencies shall be transmitted within two minutes.
 - b) Alternate Frequencies are coded in accordance with section 3.2.1.6
- 3) EAS Switching Information - Address code 31
 - a) This information is transmitted when the broadcaster needs to retune the listener to a different EAS provider
 - b) In this event, the PI code of the secondary EAS ON shall be transmitted via a burst of four 9A Variant 31's.
- 4) SAME Data conversions are located in Tables Q.1-Q.3.

TABLE Q.1 - SAME data coding conversions

SAME Acronym	Description	Bits	Type	Conversion
ORG	Originator	4	Binary	Table 2
E ₁ E ₂ E ₃	Event Code	3 bytes	ASCII	Figure E.1 Appendix E
TTTT	Event Duration			
	Hours	7	Binary	Direct
	15 minute interval	2	Binary	Table 3
JJJHHMM	Origination Date/Time			
JJJ	Julian Date	9	Binary	Direct
HH	Hours	5	Binary	Direct
MM	Minutes	6	Binary	Direct
L ₁ L ₂ L ₃ L ₄ L ₅ L ₆ L ₇ L ₈	Originator ID	8 bytes	ASCII	Figure E.1 Appendix E
PSSCCC	Location Code			
P	Portion	8	ASCII	Figure E.1 Appendix E
SS	State	7	Binary	Direct - State FIPS #
CCC	County Code	10	Binary	Direct - County FIPS #
Location_Count	PSSCCC Count ⁽¹⁾	7	Binary	Direct

Note: 1) The PSSCCC Count represents the total number of PSSCCC codes that comprise the warning message.

TABLE Q.2 - Originator Codes

O ₃	O ₂	O ₁	O ₀	ORG CODE
0	0	0	0	EAS
0	0	0	1	CIV
0	0	1	0	EAN
0	0	1	1	WXR
0	1	0	0	PEP
0	1	0	1	Undefined
-	-	-	-	
1	1	1	1	Undefined

TABLE Q.3 - Time Minute Interval

Tm ₁	Tm ₀	Description
0	0	0
0	1	15
1	0	30
1	1	45

ANNEX R (normative)

In-Receiver Database System (I-RDS) File Structure

The material in Annex R and section 7 is proprietary and requires the acquisition of a license from its owner for its implementation in hardware, firmware and/or software.

R.1 I-RDS Header File

The I-RDS Header File is shown in Figure R.1. This file contains pointers to (addresses of) the start and end of each of the other files in the ROM. Each of these pointers are at absolute (unchanging) locations. This permits the location and size of each file in the ROM to vary as needed. In other words the Header File is the only file which is always located at the same address in the ROM (always address 0) and whose structure is fixed.

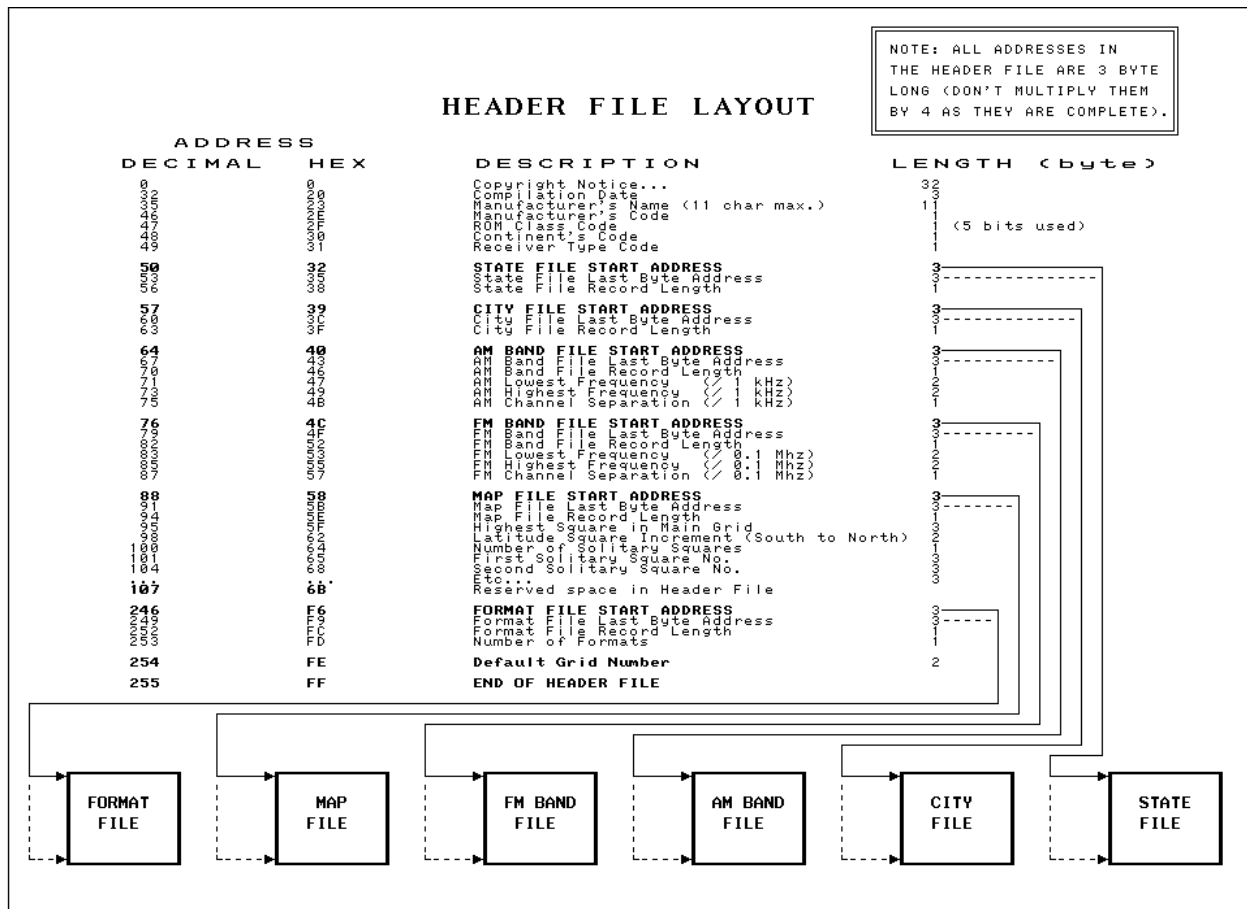

Figure R.1 The Header File

NOTE: All pointers in the Header are three bytes long and are given in the following order: Byte1 of the pointer - most significant byte of the address; Byte2 of the pointer - middle byte of the address; Byte3 of the pointer - least significant byte of the address.

R.2 Cross-referencing Pointers and Counters

The In-Receiver Database System relies on a system of cross-referencing pointers and counters which permits the CPU to locate records related to each other, whether they belong in the same file or not.

For example a record in the FM Band File describing a radio station will point to an address in the City File where that station's city of license is located and described. Likewise that city's record will contain pointers to the AM and FM Band Files to indicate the first radio station in each band (defined as the station with the lowest frequency) which can be found in the Grid in which the city is located.

Similarly, the City File contains a State Counter in each of its records. This counter permits the CPU to determine the proper state (or province) for each city.

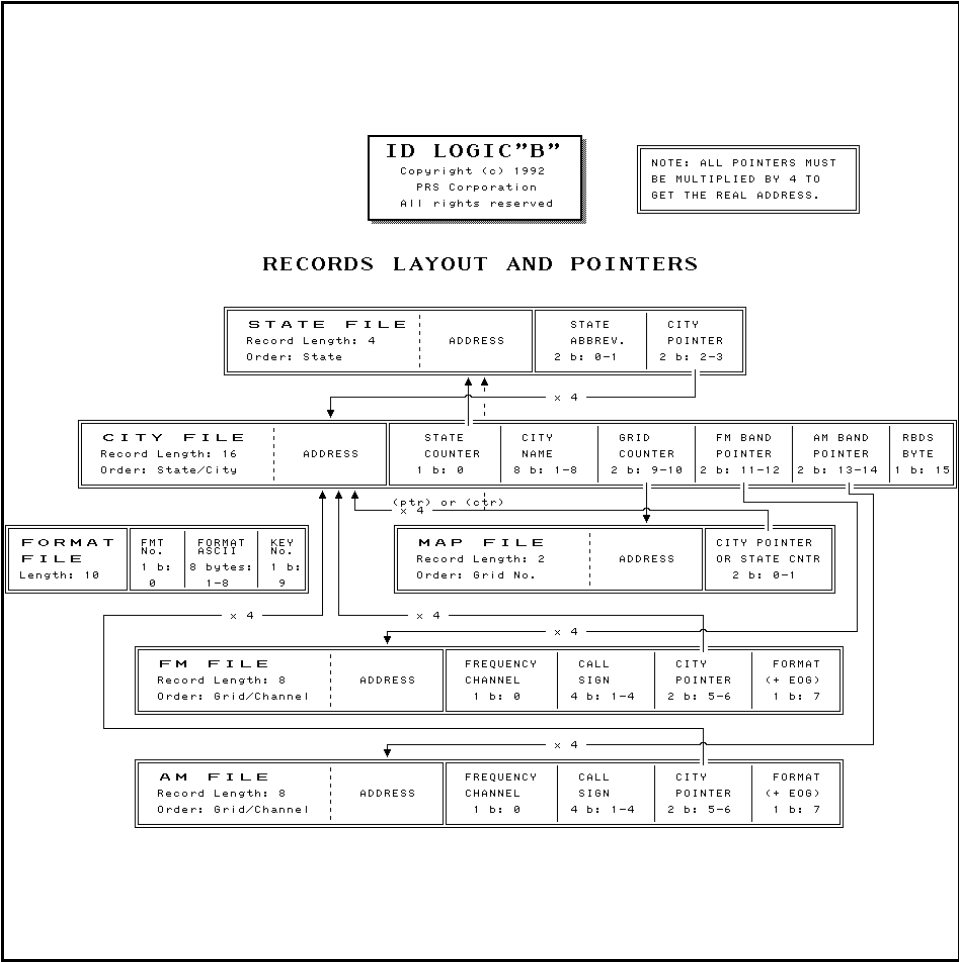

R.3 Pointer Arithmetic

Since the I-RDS ROM has an address space of 256 kilobytes, each discrete address would require 18 bits. In order to conserve space in the files, all pointers have been reduced to two bytes.

This is achieved in three steps:

- 1) All files start on an even boundary (R.S. Bytes = 00 or modulo 100hex)
- 2) The files which are referenced by pointers (the City File, and both Band Files) are formed of records of 16 bytes and 8 bytes respectively. This ensures that each record in these files also starts at an address of modulo 8 -- where at minimum the least significant two bits are always equal to 0.
- 3) All pointers which reference these three files are first divided by 4 (two bitwise shift to the right) before they are stored in the files. (NOTE: This is true of all files except of the Header File where all pointers are 3 bytes long and where they denote real addresses.)

Then, when actually using such a pointer, a two bitwise shift to the left (a multiplication by 4) is performed to restore the actual real address of interest.

R.4 Counter Arithmetic

When appropriate, counters are used instead of pointers. An address is derived from a counter with the following formula:

$$\text{Address} = (\text{Counter} - 1) * \text{Record_Length} + \text{File_Start}$$

Figure R.4 Counter arithmetic

Each of the variables (record length and file start address) can be found in the Header File at their own addresses (See Figure R.1). Since all record lengths are powers of 2 the multiplications required can be reduced to simple bitwise shifts to the left.

R.6 - City File Layout

Each record in the City File is composed of six fields:

- The state counter
- The city name (abbreviated to eight characters)
- The Grid counter which indicates the location of the city in the grid system
- The FM band pointer referencing the first (lowest frequency) FM station in the Grid
- The AM band pointer referencing the first (lowest frequency) AM station in the Grid
- Unassigned RBDS flags (eight bits available)

NOTE: In addition to the eight bits of the last byte, the eight high bits of the city name are also available for RBDS flags (for a total of 16 bits).

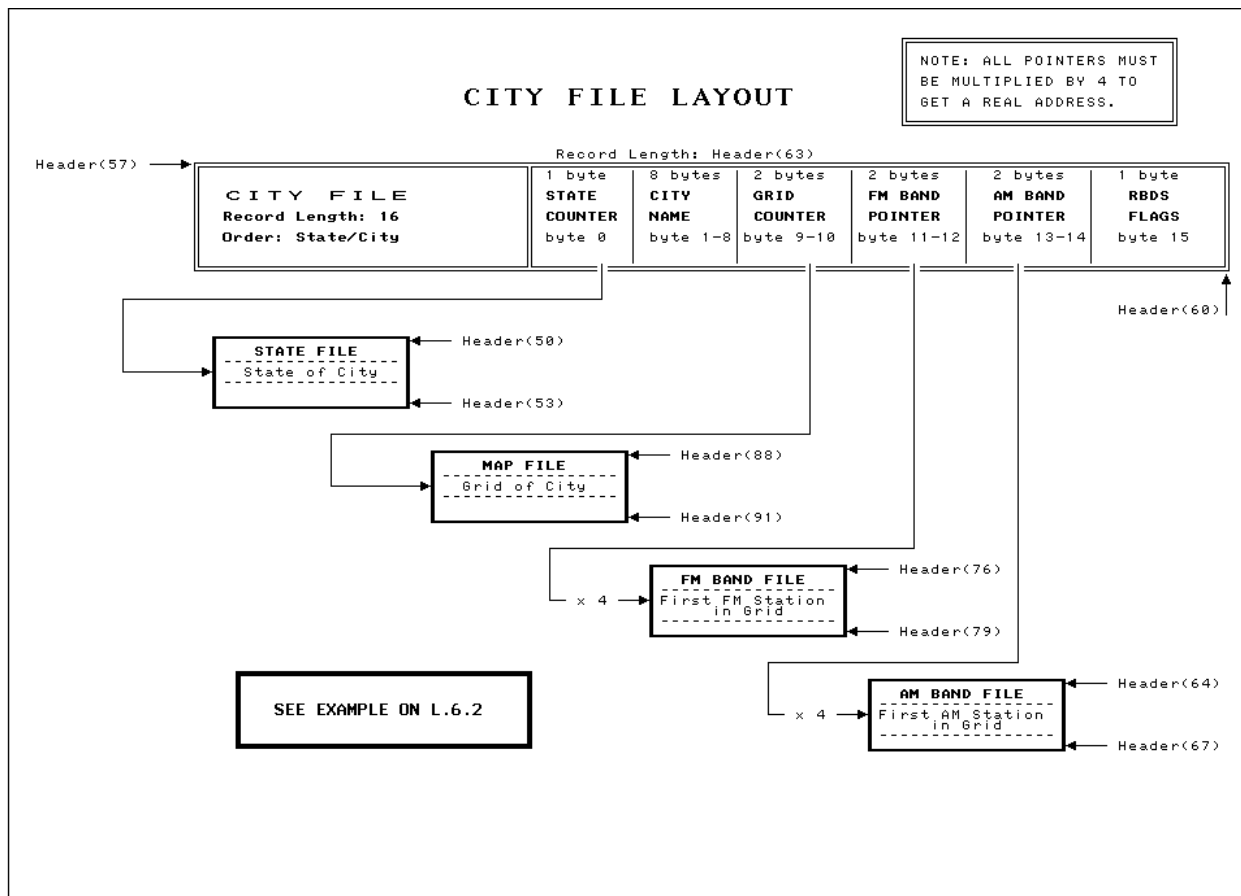

Figure R.6.1 - City File layout

The City File is ordered alphabetically by states and by cities (full name) within each state.

See section R.12.3 for application notes.

The following figure provides an example of the application of the City File as illustrated in Figure R.6.1.

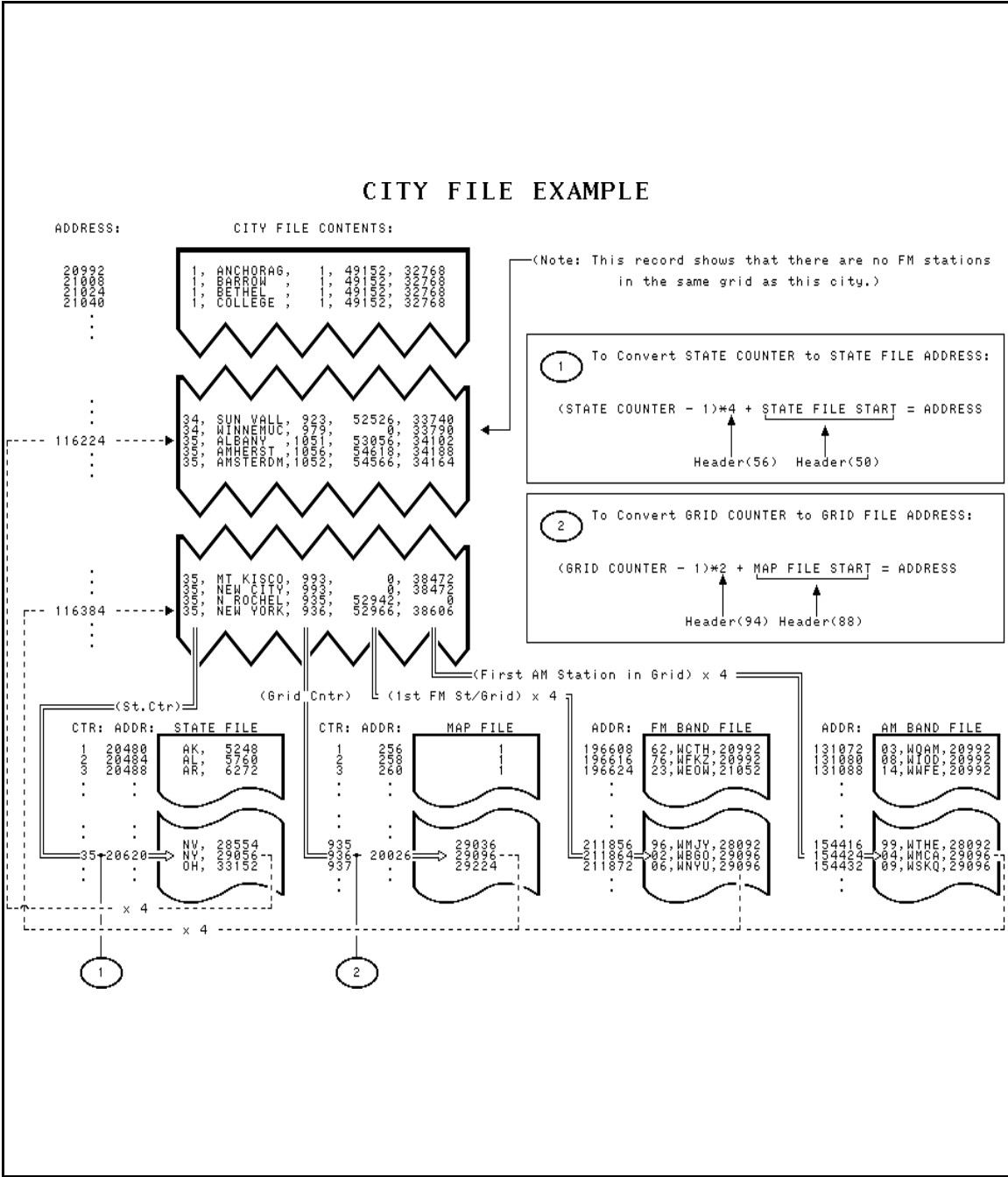

Figure R.6.2 - City File layout example

Notes 1 and 2 of Figure R.6.2 apply the equation defined in Figure R.4 (Counter Arithmetic) converting counters to addresses.

R.8 - FM Band File Layout

See section R.12.4. for application notes.

Each record in the FM Band File is composed of four fields:

- The channel (frequency)
- The callsign (four ASCII characters)
- The city pointer (indicating the city of license)
- The format (usual PTY)

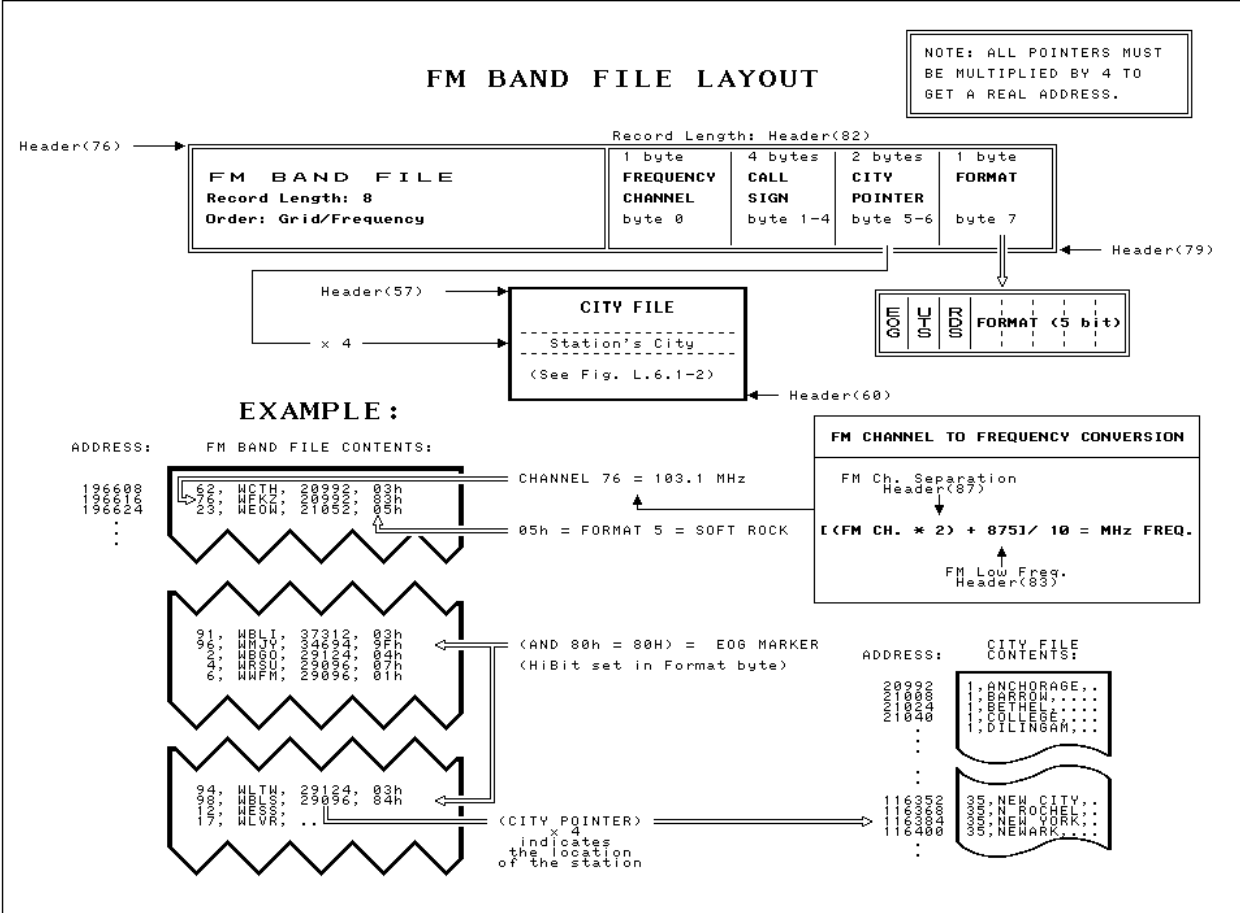

Figure R.8 - FM Band File layout

The FM Band File is ordered by ascending Grid number and by ascending frequencies within each Grid.

R.10 Travel and Map File Calculations

The figure below illustrates the calculations needed to find the Grid number of the eight Grids that are contiguous to a particular location.

The value of the constant needed (L) is found in the Header File at address 98₁₀.

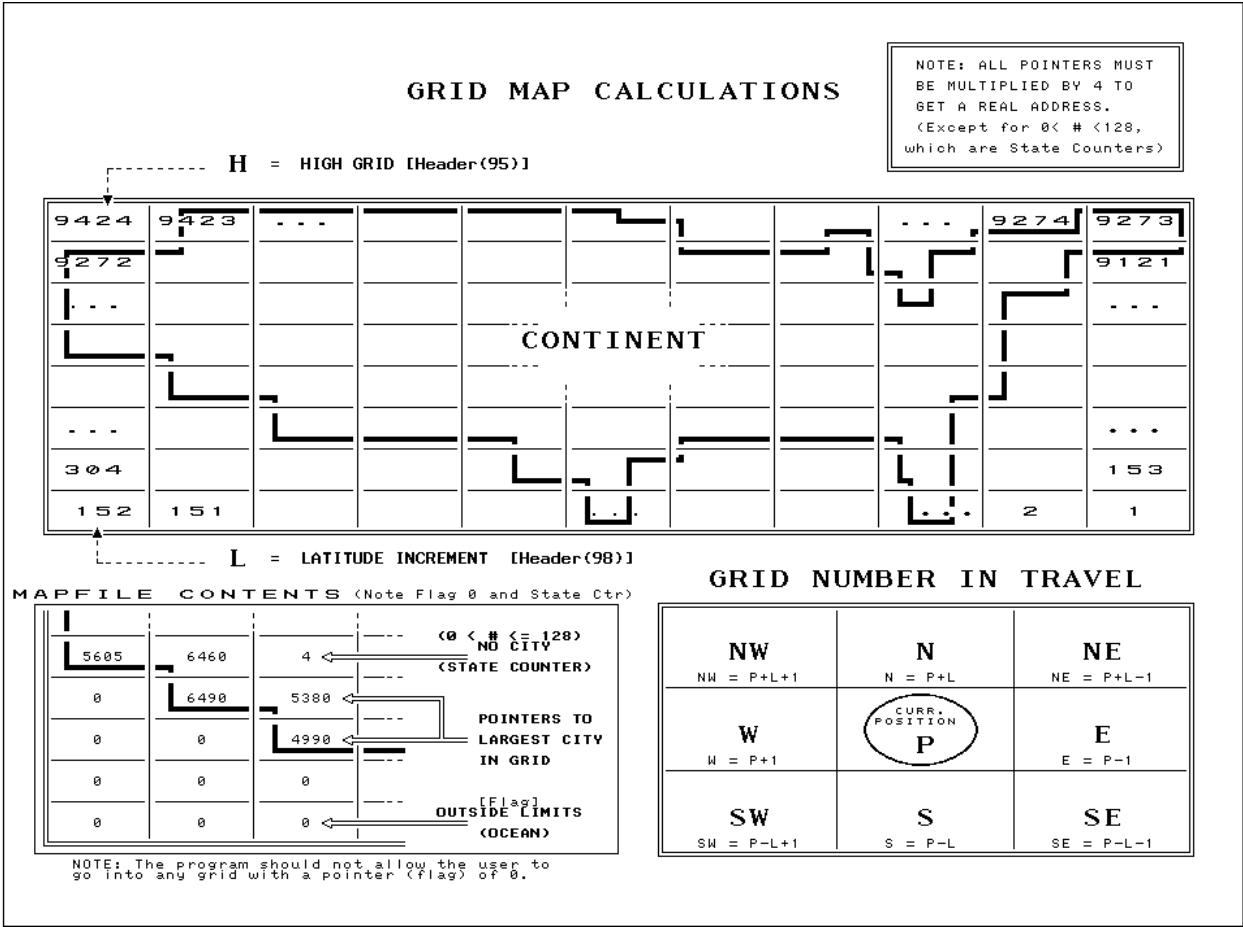

Figure R.10 Map file calculations

See section R.12.5 for application notes.

R.11 Format File Layout

Each record in the Format File is composed of three fields:

- The format number (0 - 31) which indexes a precise format
- The format name (eight ASCII characters)
- The format key (group) number which indexes the front panel fixed format keys.

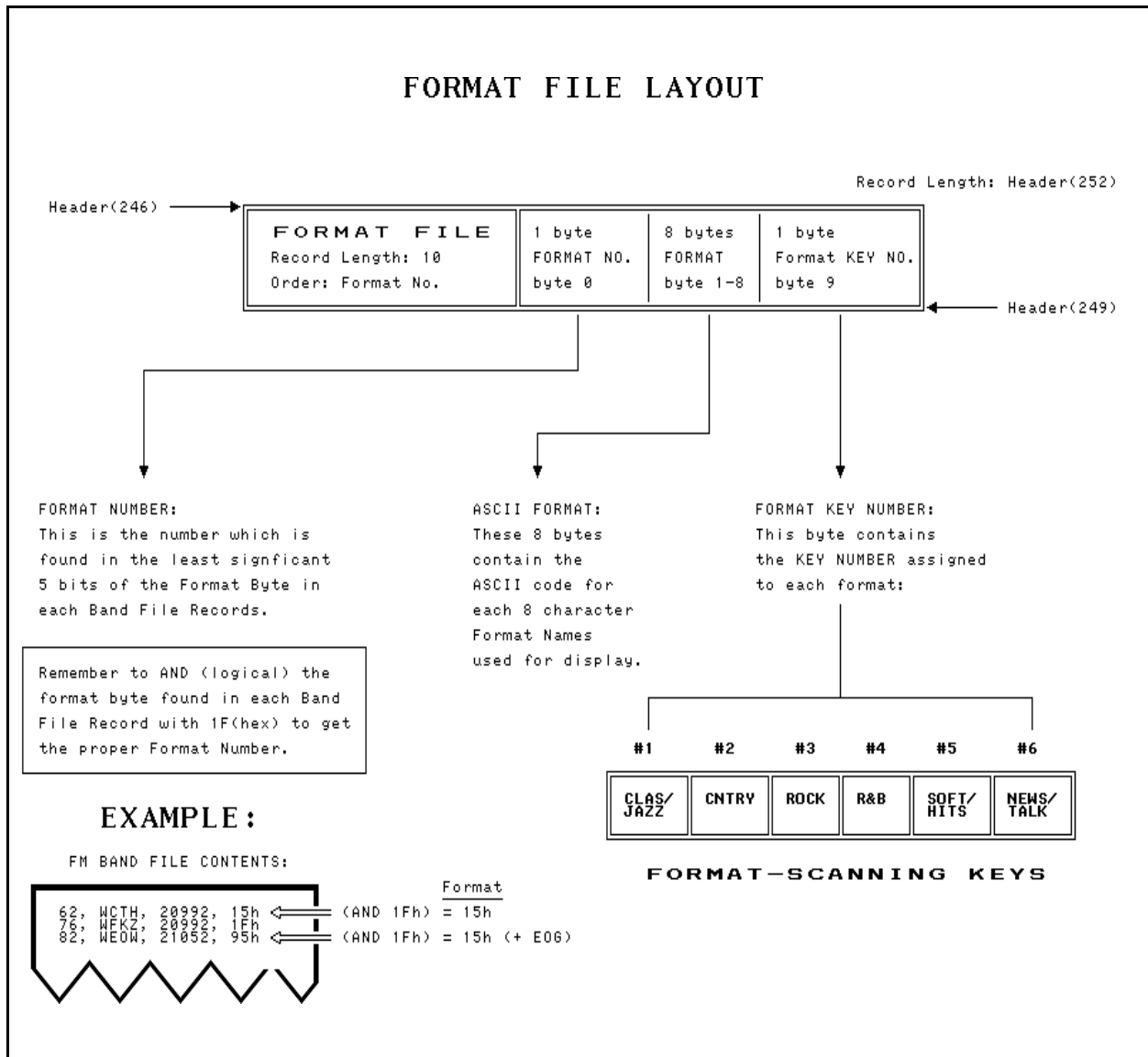

Figure R.11 Format file layout

See section R.12.6 for application notes.

R.12 Application Notes

R.12.1 Header File

R.12.1.1 Address: The Header File always starts at address 0 of the ROM. Its structure is fixed. (See Figure R.1).

R.12.2 State File

R.12.2.1 Header references: The State File is referenced in the Header File as follows:

Address 50_{10} = State File start address
Address 53_{10} = State File end address
Address 56_{10} = State File record length

R.12.2.2 Order: The State File is ordered alphabetically by state abbreviation -- as opposed to the City File which is ordered alphabetically by city full name.

R.12.2.3 Count: In the current implementation of I-RDS, there are 61 states/provinces in the file:

51 All U.S. states + the District of Columbia
10 Canadian provinces whose territories lie partly below 54 degree latitude
1 entry for Mexico
62

R.12.2.4 City pointer: Each city pointer in the State File points to the largest (most populated) city in the state or province referenced.

R.12.3 City File

R.12.3.1 Header references: The City File is referenced in the Header File as follows:

Address 57_{10} = City File start address
Address 60_{10} = City File end address
Address 63_{10} = City File record length

R.12.3.2 Band pointers: As can be seen in Figure R.6.1, each City File record contains two band pointers (FM in bytes 11-12 and AM in bytes 13-14). These band pointers reference the first (lowest frequency) station in the Grid in which the city is located.

R.12.3.3 Null band pointer: If, for example, the FM pointer is equal to zero (0), this indicates the Grid does not contain any FM station. The same applies to AM pointers.

R.12.3.4 Filler cities: Some filler cities (cities with no AM or FM stations) may be added to the City File (and the Map File) to provide a meaningful feedback when a travel (compass) key is actuated. This is particularly needed when traveling through a sparsely populated region. If these cities are located in a Grid where no station exist, then both band pointers will be equal to zero.

R.12.4 Band File (AM and FM)

R.12.4.1 Header references: The Band Files are referenced in the Header File as follows:

Address 64_{10} = AM Band File start address
Address 67_{10} = AM Band File end address
Address 70_{10} = AM Band File record length
Address 71_{10} = AM lowest frequency (/1 kHz)
Address 73_{10} = AM highest frequency (/1 kHz)
Address 75_{10} = AM channel separation (/1 kHz)
Address 76_{10} = FM Band File start address
Address 79_{10} = FM Band File end address
Address 82_{10} = FM Band File record length
Address 83_{10} = FM lowest frequency (/100 kHz)
Address 85_{10} = FM highest frequency (/100 kHz)
Address 87_{10} = FM channel separation (/100 kHz)

R.12.4.2 Order: The Band Files contain the list of all stations in the continent. They are placed in ascending Grid order and, within each Grid, ordered by ascending frequency.

R.12.4.3 End-of-Grid flag (EOG): Each record of the City File provides a pointer to each Band File. This pointer references the first station (lowest frequency), in each Grid, in its respective Band File. An end-of-grid flag (EOG) is provided in the high bit of the Format byte found in the Band Files record (On = EOG; Off = normal) of the last (highest frequency) station of each Grid.

Note: The EOG flag is needed as it is possible for two successive Grids to follow each other in which the first station in the second Grid is of a lower frequency than that of the last station in the first Grid.

R.12.4.4 RBDS Reserved bits:

- Bit 5 (RDS) of the Format byte is reserved to indicate the station is a participating RBDS station
- Bit 6 (UTS) of the Format byte is reserved to indicate the station is a participating RBDS station and that it is providing in-receiver database updates via the open data channel.
- There are another two bits available for RBDS flags. These are the high bits (bit 7) of byte 2 and 3 of the station's call sign. Bit 7 of byte 0 is reserved to indicate an off-the-air or erased status. Bit 7 of byte 1 is reserved for band indication (see sections R.13.3.3 and R.13.3.4).

Note: One application of these bits is to indicate that the station is a null station -- that is one which is currently not on the air. Another possible application is the indication that a station is part of an emergency network so that the receiver can tune to it immediately upon the reception of a signal or user prompting.

R.12.5 Map File

R.12.5.1 Header references: The State File is referenced in the Header File as follows:

Address 88₁₀ = Map File start address
Address 91₁₀ = Map File end address
Address 94₁₀ = Map File record length
Address 95₁₀ = Index of highest -- Northwestern most -- Grid (H)
Address 98₁₀ = Latitude Grid increment (L) -- South to North
Address 100₁₀ = Number of Solitary Grids (see below).

R.12.5.2 Contents: As indicated in Figure R.9, each record of the Map File can contain one of three types of information:

- A city pointer (referencing the largest city in the Grid)
- A state counter (indicating the Grid's state)
- A boundary flag (0).

R.12.5.3 State counter: A state counter is present if there is no city in that Grid. This is necessary to give a usable amount of feedback to the user even if he or she travels through a desert or mountainous region or other sparsely populated area. In that case and when the user crosses a state boundary that information can be conveyed on the display.

R.12.5.4 Boundary flag: The boundary flag is provided for two reasons:

- To forbid travel to off-limit areas (for example in the ocean)
- To avoid a mathematical wrap-around effect which would permit a user, for example, to travel East from, say, Georgia and arrive in California.

R.12.5.5 Solitary Grids: Some grids are special cases. These are called Solitary Grids and travel to and from such grids should not be permitted while using the travel (compass) keys.

Some of the areas covered by the in-receiver database lie well outside the continental U.S.A. (e.g., Alaska, Hawaii, Northern Canada). In order not to extend the grid system to cover such areas and make the Map File inordinately large, those areas have been assigned special status and have been placed in the first few Grids of the main grid system (as they are out of bounds -- in the ocean). These are:

- Grid 1 = Alaska
- Grid 2 = Hawaii
- Grid 3 = Newfoundland
- Grid 4 = Canadian areas above the 54th parallel.

The number and index of such Solitary Grids can be found in the Header File (see Figure R.1) as follows:

Address 100₁₀ = Number of Solitary Grids
Address 101₁₀ = Solitary Grids No. 1
Address 104₁₀ = Solitary Grids No. 2
Address 107₁₀ = Etc.

Addresses 101₁₀ to 245₁₀ have been reserved in the Header File for the listing of such Solitary Grids.

R.12.5.6 Default Grid: At address 254₁₀ of the Header File, one can find a Default Grid which indicates the location of Washington, DC.

Note: Upon installation, or upon software reset, the program can automatically relocate itself in the Default Grid.

R.12.6 Format File

R.12.6.1 Header references: The Format File is referenced in the Header File as follows:

- Address 246₁₀ = Format File start address
- Address 249₁₀ = Format File end address
- Address 252₁₀ = Format File record length
- Address 253₁₀ = Number of (detailed) formats

R.12.6.2 Contents: As indicated in Figure R.11, each record of the Format File is formed of three fields:

- A (precise) format number
- An ASCII representation of the (precise) format -- for display
- A (group) format key number.

R.12.6.3 Precise Format: The precise format indicates one of 32 possibilities. I-RDS proposes to use formats identical to the RBDS program types (PTY) as defined in Annex F.

R.12.6.4 Format Groups and Keys: Each precise format is assigned to a group which, in turn, is assigned to one of the receiver's front panel format scanning keys.

The current assignment is as follows:

Table R.12.6.4

1 - Classical / Jazz / Public	4 - Rhythm & Blues
2 - Country & Western	5 - Soft / Hits
3 - Rock	6 - News / Talk

R.13 - Update RAM Layout

The 2 kilobyte update RAM is divided into four main areas:

- The RAM Header File
- The Update Data File
- The New Station File
- The Preset Memory area and a General Purpose RAM area.

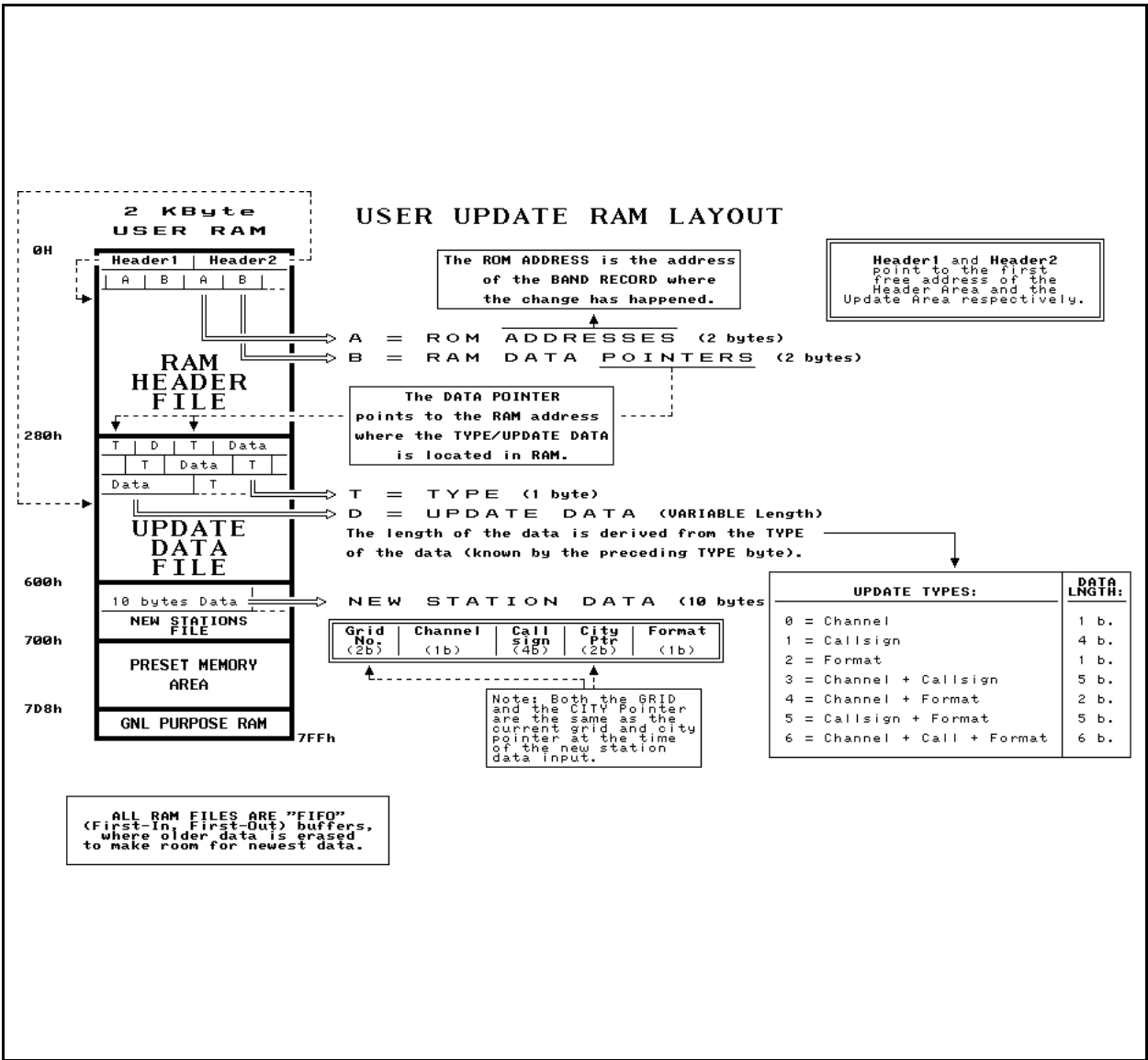

Figure R.13.1 - Update RAM layout

R.13.1 - RAM Header File

The RAM Header File contains four types of information:

- The Header1 (two bytes)
- The Header2 (two bytes)
- ROM pointers (two bytes each)
- RAM data pointers (two bytes each)

R.13.1.1 - Header1: This header points to the address of the first free byte in the RAM Header File.

R.13.1.2 - Header2: This header points to the address of the first free byte of the Update Data File.

Header1 and Header2 are provided to permit data entry by both the user (manually) and by the automatic downloading method via RDS open data channel.

R.13.1.3 - ROM pointers: These pointers reference the address in ROM which is occupied by the record to be updated. Remember to multiply these pointers by 4 (two bitwise shifts to the left) in order to get the actual ROM address as these pointers are stored in only two bytes.

The actual update data (in the RAM Update Data File) is referenced by the pointer immediately following the ROM pointer.

R.13.1.4 - RAM Data pointers: These pointers reference the address in the RAM Update Data File in which the update data is located. Each such pointer is immediately preceded by the ROM pointer (see R.13.1.3) referencing the address in ROM where the record to be updated is located.

The ROM pointers and the RAM Data pointers always form a pair.

R.13.2 - Update Data File

The Update Data File contains two types of information:

- The Update Data Type (1 byte)
- The Update Data (variable length).

R.13.2.1 - Stored Update Data Type (SUDT): Each update data is type-coded to indicate two things:

- The type of the update data
- The length of that update data.

The length of the data is derived from the SUDT.

The following table lists all possible Stored Update Data Types and their lengths:

STORED UPDATE DATA TYPE	DATA LENGTH (in byte)
0 = Channel	1
1 = Call sign	4
2 = Format	1
3 = Channel + Call sign	5
4 = Channel + Format	2
5 = Call sign + Format	5
6 = Channel + Call sign + Format	6

Table R.13.2 - Stored Update Data Types

R.13.2.3 - Housekeeping: When storing update data, both Header1 and Header2 (see R.13.1.1 and R.13.1.2) should be updated to reflect the address of the first free bytes in the RAM Header File and the Update Data File.

All RAM files are FIFO (first in, first out) buffers, where (if necessary) oldest data is erased to make room for newest data.

R.13.2.4 - Number of updates: The space reserved for each file in the RAM dictates the maximum number of updates which can be stored. With the recommended boundaries as shown in Figure R.13.1, the maximum number of (non-new stations) updates possible is $[(27F_{\text{hex}} - 4)/4] = 158$.

Note: The Update Data File (from 280_{hex} to $5FF_{\text{hex}}$) can store 202 average entries or 127 maximum length entries (of 7 bytes each).

R.13.3 New Station File

The New Station File is composed of fixed-length records of 10 bytes each:

- Grid number (2 bytes)
- Channel (1 byte)
- Call sign (4 bytes)
- City pointer (2 bytes)
- Format (1 byte)

This file is provided to store the details of stations which come on the air after ROM manufacture.

R.13.3.1 Header: The first byte of the New Station File is reserved to contain the number (N) of new station entries in the file. The address of the first free byte in the file can be calculated with:

$$\text{Address} = \text{Start_of_file} + 1 + 10*N$$

R.13.3.2 Grid number: This counter references the Grid in which the station is located.

Note: Although this information can be deduced from the City pointer (see section R.13.3.5 and Figure R.6.1) it is provided to speed up RAM lookup when scanning for stations in a particular area.

R.13.3.3 Channel: The channel is converted to a frequency by using the formula in Figure R.7 (for AM) or Figure R.8 (for FM) depending on the high bit of byte 2 of the call sign. This bit is set (1) to indicate an FM station and reset (0) to indicate an AM station.

R.13.3.4 Call sign: The high bits (bit₇) of the four ASCII characters composing the call sign are used as follows:

High bit of byte 0:	0 = normal; 1 = off-the-air
High bit of byte 1:	0 = AM; 1 = FM
High bit of byte 2:	available (see section R.12.4.4)
High bit of byte 3:	available (see section R.12.4.4)

Note that the AM/FM flag (bit 7 of byte 1) is used only in the New Station File (in RAM) and is not necessary in the ROM band files since there the AM and FM stations are separated. However, to avoid confusion, this bit of byte 1 should not be used in the ROM.

R.13.3.5 City pointer: This references the city of license of the station. Remember to multiply this pointer by 4 to get a real ROM address.

R.13.3.6 Format: The format byte is identical to that described in Figure R.11 and in section R.12.4.4.

- Bit 5 indicates the station is a participating RBDS station
- Bit 6 indicates the station is a participating RBDS station and that it is providing in-receiver database updates via the open data channel.
- Bit 7 of the format byte (EOG) is not used in the RAM.

R.13.3.7 Number of new stations: The space reserved for each file in the RAM dictate the maximum number of updates which can be stored. With the recommended boundaries as shown in Figure R.13.1, the maximum number of new station updates possible is $(6FF_{\text{hex}} - 601_{\text{hex}})/10 = 25$.

R.13.3.8 Housekeeping: When storing update data, the header (see R.13.3.1) should be updated to reflect the address of the first free byte of the New Station File.

Note: All RAM files are FIFO (first in, first out) buffers, where (if necessary) oldest data is erased to make room for newest data.

R.13.4 - Other RAM areas

The RAM area starting at 700_{hex} and ending at $7FF_{\text{hex}}$ is available for other use such as the storage of presets, Update Transmission Header information (see section 4.7.3) and the like.

ANNEX S (normative)

List of abbreviations

The abbreviations which are commonly used in context with the Radio Data System are listed below in alphabetical order. Most of these terms are explained in the description of features (see 4).

AF	Alternative Frequencies list
ARI	Autofahrer Rundfunk Information
CI	Country Identifier
CT	Clock Time and date
DI	Decoder Identification
ECC	Extended Country Code
E.G.	Extended Generic indicator
EON	Enhanced Other Networks information
EWS	Emergency Warning System
IH	In House application
ILS	International Linkage Set indicator
LA	Linkage Actuator
LI	Linkage Identifier
LSN	Linkage Set Number
MS	Music Speech switch
ODA	Open Data Applications
PI	Program Identification
PIN	Program Item Number
PS	Program Service name
PTY	Program TYPE
PTYN	Program TYPE Name
RBDS	Radio Broadcast Data System [15]
RDS	Radio Data System
RP	Radio Paging
RT	Radiotext
TA	Traffic Announcement flag
TDC	Transparent Data Channels
TMC	Traffic Message Channel
TP	Traffic Program flag

See annex M for abbreviations associated with Radio Paging.

ANNEX T (informative)

Bibliography

- [1] Information processing systems - Open Systems Interconnection - Basic reference model. IS Publication 7498.
- [2] Bennett, W.R., and Davey, J.R.: Data transmissions.
Published by McGraw-Hill, New York, 1965.
- [3] Peterson, W.W., and Brown, D.T.: Cyclic codes for error detection.
Proceedings of the IRE, No. 49, January 1961, pp. 228-235.
- [4] Peterson, W.W., and Weldon, E.J.: Error-correcting codes.
Published by MIT Press, Cambridge Mass., second edition, 1972.
- [5] Kasami, T.: Optimum shortened cyclic codes for burst error correction.
IEEE Transactions on Information Theory (IT9), No. 4, 1963, pp. 105-109.
- [6] Hellman, M.E.: Error detection in the presence of synchronization loss.
IEEE Transactions on Communications COM-23, No. 5, 1975, pp. 538-539.
- [7] Hellman, M.E.: Error detection made simple.
International Conference on Communication, Minneapolis, Minnesota (USA), June 1974. Conference Record,
pp. 9A1-9A4.
- [8] EBU (1984): Specifications of the radio data system RDS for VHF/FM sound broadcasting. Doc. Tech 3244
and Supplements 1 to 4. European Broadcasting Union, 17A Ancienne Route, CH-1218 Geneva, Switzerland.
- [9] Swedish Telecommunication Administration (1986): Paging receiver for the Radio Data System. Doc.
1301/A694 3798 (Alternative B).
- [10] CCIR: Report 900-1 (1986) Radio-paging systems - Standardization of
code and format (Annex II).
- [11] ITU-R Recommendation 643-2 (1995) System for automatic tuning and other applications in FM radio
receivers for use with the pilot-tone system
- [12] EBU (1982): Displayable character sets for broadcast teletext (2nd edition, 1982 + corrigendum 1983).Doc.
Tech 3232. European Broadcasting Union.
- [13] EBU (1986): Specifications of the systems of the MAC/packet family.
Doc. Tech 3258. European Broadcasting Union.
- [14] EBU (1990): Proposed enhancements of the EBU on CENELEC EN 50067 (RDS).
Doc. SPB 482. European Broadcasting Union, 17A Ancienne Route, CH-1218 Geneva, Switzerland.
- [15] EIA/NAB National Radio Systems Committee: United States RBDS Standard, January 8, 1993 - Specification
of the radio broadcast data system (RBDS)
- [16] Swedish Telecommunication Administration (Televerket): Paging Receiver for the Swedish Public Radio
Paging System, Specification 76-1650-ZE (1976).
- [17] EBU (1997): Proposed enhancements on CENELEC EN50067, Draft version 2.5, European Broadcasting
Union, 17A Ancienne Route, CH-1218 Geneva, Switzerland.